

Bio-Medical Waste
INVENTORY AND STATUS OF MANAGEMENT
IN
WEST BENGAL



WEST BENGAL POLLUTION CONTROL BOARD



Technical Assistance by

Society for Direct Initiative for Social & Health Action
(DISHA)



MARCH 2010

**BIO-MEDICAL WASTE
INVENTORY AND STATUS OF MANAGEMENT
IN WEST BENGAL**

WEST BENGAL POLLUTION CONTROL BOARD

*PARIBESH BHAWAN,
10A, BLOCK LA
SECTOR III, BIDHAN NAGAR,
KOLKATA – 700098
INDIA
www.wbpcb.gov.in*

**SOCIETY FOR DIRECT INITIATIVE FOR SOCIAL & HEALTH ACTION
(DISHA)**

*20/4 SIL LANE, KOLKATA 700015
INDIA
www.dishaearth.org*

ACKNOWLEDGEMENT

This report is a result of the project scheme and guidelines formulated by the Central Pollution Control Board and the initiative of the West Bengal Pollution Control Board. Credit for the successful completion of the project goes entirely to the project team and others who have contributed directly or indirectly in the execution of the project and in the preparation of the project report.

*The West Bengal Pollution Control Board would like to gratefully acknowledge the efforts of **Society for Direct Initiative for Social & Health Action (DISHA)**, Kolkata in conducting the project: **Bio-medical Waste : Inventory and Status of Management in West Bengal** and for preparing the report.*

The State Board would also like to convey its gratitude to the concerned persons of the Government Hospitals / Health Centres, Private Nursing Homes / Healthcare establishments, various organizations and agencies who have extended their whole hearted cooperation and provided valuable inputs in making the project successful and meaningful.

The immense contribution of Professor Shyamal Kanti Sanyal, Advisor of the State Board and Ex-Vice Chancellor of Jadavpur University by providing technical help and guidance in executing the project is also highly acknowledged.

The project could never have been successfully executed without the untiring efforts of Dr. Dipak Chakraborty, Chief Scientist, Dr. T. K. Gupta, Chief Engineer, Shri Shyamal Kumar Adhikari, Senior Environmental Engineer (Waste Management Cell) and Shri Debasish Sarkar, Senior Environmental Engineer (Planning) of the State Board. Other Senior Engineers and colleagues of the Pollution Control Board also deserve appreciation for their assistance in all respects from the inception to the completion of the project. Contribution of the Accounts section of the State Board require a special mention for ensuring continuous fund support to the project.

This acknowledgement would not be complete if the name of Shri Debal Ray, Chief Environmental Officer, Department of Environment, Government of West Bengal and the Ex-Member Secretary of the West Bengal Pollution Control Board is not mentioned here. West Bengal Pollution Control Board remains thankful to Shri Ray for his initiatives for the execution of the project during his tenure.

*Sandipan Mukherjee
Member Secretary
West Bengal Pollution Control Board*

Executive Summary

Overview: Biomedical waste (BMW) consists of solids, liquids, sharps, and laboratory waste that are potentially infectious or dangerous. Out of the total waste generated by health-care activities almost 80 - 85 % is general waste comparable to domestic waste. The remaining approximately 15 - 20% of waste is considered hazardous material that may be infectious, toxic or radioactive. When all the waste is mixed together, 100% of the health-care waste turns infectious and hazardous as well as become unmanageable. According to World Health Organization (WHO) “poor management of health care waste potentially exposes health care workers, waste handlers, patients and the community at large to infection, toxic effects and injuries, and risks polluting the environment. It is essential that all medical waste materials are segregated at the point of generation, appropriately treated and disposed of safely.”

Background of the Study: Efforts towards safe and proper management of bio-medical waste in West Bengal date back to the 1990s, even prior to the introduction of the Bio-Medical Waste (Management and Handling) Rules, 1998. Dept. of Health & Family Welfare, Govt. of West Bengal took initiative towards this through several projects. With the introduction of the BMW Rules in 1998, WBPCB became the designated authority to approve and monitor BMW management in the state. After ten years of the introduction of BMW Rules, it is imperative to assess the achievements and the failures, the problems and the prospects of BMW management in the state. Thus the study “*Bio-medical Waste : Inventory and Status of Management in West Bengal*” was undertaken.

Study Objectives: The study was conducted from November 2008 to March 2010. Objectives of the study was to (a) prepare an inventory of health care establishments, which are sources of BMW in West Bengal, (b) quantify amount of BMW generated to derive average generation in different categories of health care units, (c) make an assessment of treatment and disposal options, (d) assess availability and further requirement of common BMW treatment facilities (CBWTFs), (e) suggest options for BMW management in remote areas beyond reach of CBWTFs and (f) make assessment of compliance status in some selected Health Care Units (HCUs).

Inventory of HCUs: West Bengal has a vast network of government HCUs in urban and rural areas. *As per data available in December 2008* the Dept. of Health & Family Welfare has 11 tertiary (Medical College and Hospitals), 213 secondary (District, Sub-Divisional, State General and Rural Hospitals), 1168 Block Primary and Primary health centres in the state. Total number of hospitals *run by different departments of state and central governments, urban local bodies and private organizations* is 3780 and number of beds is 102949.

There are also 10356 government (rural) and 2100 urban sub-centres which perform mainly immunization activities. These sub-centres also conduct outreach sessions in remote villages. Numbers of municipal (urban) sub-centres and Extended Special Outdoor Patients Department (ESOPDs) are 1740 and 48 respectively.

Number of diagnostic centres in the state is 3169 among which BMW is generated mainly by 2572 pathological centres.

Quantification: Total BMW generated in the state from these facilities is around 12000 MT per year. With a rate of increase of 1% per year, the annual generation of BMW in the state has been estimated to be nearly **13500 MT in the year 2020.**

45% of the BMW as a whole is made of recyclable materials. If the recyclable items can be properly segregated, decontaminated and then recycled, a good amount of resources can be saved in environment-friendly manner. But if these are salvaged through unscrupulous recyclable trade practices or incinerated or left in dumpsites, huge risk of environmental pollution and adverse health effect cannot be avoided.

Treatment Facilities Available: At present 5 large Common BMW Treatment Facilities (CBWTFs), 2 small CBWTFs and 14 Stand-Alone Treatment Facilities are functioning in the state. **But as a whole only 28% of BMW is being treated as most of the HCUs are yet to be incorporated in the management regime.** The situation varies from region to region. It is to be noted that maximum proportion (42%) of BMW treatment is taking place in South Region (Kolkata, Howrah and South 24 Parganas) whereas lowest proportion (5%) of BMW is being treated in the adjacent South-West region (West and East Midnapore). Proportion of BMW treated in other regions is as in the following: 29% in Central (Murshidabad, Nadia, North 24 Parganas and Hoogly), 14% in West (Bankura, Burdwan, Birbhum and Purulia) and 14% in North (Coochbehar, Jalpaiguri, Darjeeling, Uttar Dinajpur, Dakhsin Dinajpur and Malda) regions.

However it is hoped that situation will improve within a short period. As per decision of joint monitoring committee initiated by WBPCB, **Dept. of H&FW made a budgetary provision for management of BMW and has issued circular (vide No. HF/O/MS/316/W-99/2008 dtd 28.5.09) conferring authority to respective heads of the Government HCUs to come in agreement with the CBWTFs.** As the government HCUs have major number of beds and produce bulk of the BMW, in all probabilities there will be a marked improvement in the situation if the above order is implemented.

Further Requirement of Treatment Facilities: BMW treatment capacity as a whole available in the state is 100% of its present generation. But that does not indicate that the capacity is enough in all the regions. CBWTF has to be made available within an optimum distance from the generation point of BMW. In South (Kolkata, South 24 Parganas and Howrah districts), Central (North 24 Parganas, Nadia, Murshidabad

and Hooghly districts) and North regions (Coochbihar, Jalpaiguri, Darjeeling, Uttar Dinajpur, Dakshin Dinajpur and Malda districts) capacity available for BMW treatment falls much short of requirement, whereas it is largely in excess in West (Bankura, Burdwan, Birbhum and Purulia districts) and South-West (East Midnapore and West Midnapore districts) regions. To cater to the requirement both by capacity and accessibility **it is recommended that three more facilities should come up - 1 in South 24 Parganas (30000 bed capacity) for South region, 1 in Hooghly (15000 bed capacity) for Central region and 1 in Malda or Dakshin Dinajpur (15000 bed capacity) for North region.**

Options for HCUs beyond CBWTF Reach: There are many small non-bedded HCUs like govt. and municipal sub-centres, outreach sessions, which individually generate very small amount of BMW, but because of their huge number, together they generate around 8% of the total BMW. Again there are several HCUs, which are not so small but situated at remote and inaccessible places like hills and Sundarbans. CBWTF vehicles cannot visit these HCUs in regular frequency because of geographical or economical constraints. In the case of sub-centres, outreach sessions a BMW kit with safety box, syringe cutter, bleaching powder etc. should be used. BMW should be segregated at the point of generation. The kit should be used for carrying and transporting the BMW to the nearest treatment facility or storage for handing over to CBWTF. In case of other HCUs local arrangements for treatment and disposal should be opted for.

Present Status of BMW Management: Compliance status of in-house management of 8 Medical Colleges, 17 District Hospitals and 30 other HCUs including government, municipal, private and specialty establishments was studied. **It is observed that though the infrastructure for treatment of BMW in the state is almost adequate and highest authorities including monitoring body are waking up to the issue, overall status of in-house management of BMW in the HCUs especially which are owned by government or municipalities, are not at all up to the mark.**

(a) Many HCUs are yet to join CBWTFs, (b) even the large HCUs do not have any designated official exclusively responsible for BMW management though huge amount of resources is being spent for this purpose, (c) almost all the health workers severely lack awareness, motivation and training, (d) BMW management equipments and personal protective equipments are not adequately available everywhere and wherever available those are not properly used by the health workers, (e) bins are seldom placed at right places, (f) quality of segregation in general is very poor. **Mixing of bio-medical waste with general waste and non-incinerable waste with incinerable waste is rampant.** This creates enormous risk of environmental pollution and workers safety, (g) many govt. HCUs are not handing over BMW properly to the CBWTFs in spite of the fact that CBWTF vehicles report to those HCUs daily and the government is spending a huge amount towards

payment to the CBWTFs on the basis of patient occupancy, (h) a good proportion of BMW is being salvaged by the unscrupulous traders of recyclables in connivance with some corrupt health workers, (i) HCU specific regular, competent monitoring is absent.

Mercury Waste Management: Mercury is used in both elemental and compound form in different practices and equipments in health care. But there is least concern and awareness regarding mercury waste. While many of the countries have banned use of mercury in health care sector, the Central Ministry of Health and Family Welfare has issued notification for phasing out of use of mercury in central government hospitals, the state health authorities are yet to take such step . It has been estimated that at least 32 Kg. of mercury waste is generated only from broken thermometers in bedded HCUs in the state. Almost all of which, somehow or other, is released to the environment. While 1 microgram is sufficient to create enormous effect on health and environment, the issue deserves immediate attention of the state government and the monitoring body.

Recommendations:

1. Emphasis need to be given on **South-West** (East and West Midnapore), **West** (Bankura, Burdwan, Birbhum Purulia) and **North** (Coochbehar, Jalpaiguri, Darjeeling, Uttar Dinajpur, Dakshin Dinajpur and Malda) regions to pursue the HCUs to come under agreement with respective CBWTFs.
2. Dept. of H&FW, municipal corporations and municipalities need to be pursued to institute regular collection mechanism of BMW from non-bedded HCUs and arrange their proper treatment and disposal.
3. Initiative should be taken towards installation of 3 more CBWTFs - **1 in South** 24 Parganas (30000 bed capacity), **1 in Hoogly** (15000 bed capacity) and **1 in Malda or Dakshin Dinajpur** (15000 bed capacity).
4. As a good amount of recyclable materials including PVC is coming to CBWTFs mixed with incinerable waste, feasibility of introducing secondary segregation at CBWTFs with environmental precautions need to be probed.
5. Random vigilance to improve in-house BMW management should be continued in a regular manner.
6. Dept. of H&FW, municipalities and private hospital authorities should be pursued to introduce proper monitoring system either by themselves or engaging expert bodies to look after in-house BMW management fixing specific responsibilities.
7. Off-the-job and on-the-job trainings should be conducted for health workers in a regular manner with refresher training. BMW management should be given due priority in curriculum of medical and nursing students. Efforts to be taken to generate awareness and motivation of health workers at all levels.
8. Decisions should be taken to phase out use of mercury compounds and instruments in a time bound manner. Till such phasing out, proper protocol for mercury waste management should be introduced in all HCUs.

Contents

<i>Section</i>	<i>Pages</i>
A. Abbreviation	1
B. Introduction	1 - 7
Overview	1
Background of the Study	2
Study Objective	2
Study Period	2
Scope of Activities	2
Methodology	3
Detailed Methodology	4
C. Project Team	1
D. Inventory of Sources of BMW	1 - 22
Introduction	1
Objective	1
Categorization of HCUs	2
Methodology	2
Source of Primary and Basic Data	4
Lay-out for Inventory of HCUs	5
Data Processing	6
Constraints	7
Summary Findings	8
District-wise data of all bedded HCUs	9
District-wise data of Govt. bedded HCUs	13
District-wise distribution of bedded HCUs by category	15
Overview	18
District-wise data of non-bedded HCUs	19
E. Quantification in Selected HCUs	1 - 22
Objective	1
Names of Selected HCUs for Assessment	3
Methodology of Quantification	5
Constraints	7
Quantification Data	7
F. Quantification Summary	1 - 12
Average Waste Generated in Different Categories of HCUs	1
Annual BMW Generation in West Bengal	4
Growth Rate	9
Proportion of BMW generation in different sources	11
Proportion of Recyclable and Non-recyclable in BMW	11

G. Present Status of Treatment and Disposal	1 - 17
Background	1
Initiatives of WBPCB and Health Department	1
Present Status of Treatment and Disposal Facilities	2
Methodology	3
Prescribed procedure of Treatment as per BMW Rules	3
Existing Practices of Treatment, Segregation and Disposal	4
CBWTFs in West Bengal	7
Stand Alone BMW Treatment Facilities	9
Total Amount of BMW Treatment in the State	10
Region-wise Treatment of BMW in the State	11
Region-wise Account of BMW Treatment in relation Generation	12
Comparison between BMW Generation and Treatment Capacity	13
Requirement of more CBWTFs in West Bengal	15
Treatment of Recyclables and Non-recyclables in CBWTFs	16
Issue of Incineration Ash in CBWTFs	17
H. Options Beyond Reach of CBWTFs	1 - 11
Options for Collection and Treatment in RH/BPHC/PHC	2
Flow Chart	3
Options for SC, ORS, Municipal SC, ESOPD, Health Camps	6
Flow Chart	7
Highlights of the System	11
I. Present Status of In-house Management	1 - 18
HcUs surveyed for Assessment of in-house Management	1
Methodology of Assessment of Status	3
Observations	3
Conclusion	14
Score Sheet	14
Average Performance Level of Different categories of HcUs	18
I. Mercury in Health Care Waste	1 - 8
The Context	1
Reduction of Mercury in Health Care Sector	3
Indian Situation	3
Situation in West Bengal	4
Quantification of Mercury Waste	6
Average Consumption of Mercury Thermometers in HcUs	7
Mercury Waste Generated from Thermometer in West Bengal	8
J. Recommendations	1 -2

Annexure

I. List of HCUs	1 - 120
II. List of Diagnostic Centres	1 - 75
III. Detailed Quantification data for Selected HCUs	1 - 28
IV. District-wise Quantification Summary for the State	1 - 61

Abbreviations	
Codes	Categories
AMBH	Leprosy Hospital
BMOH	Block Medical Officer, Health
BMW	Bio-medical Waste
BPHC	Block Primary Health Centre
CBWTF	Common Bio-medical Waste Treatment Facility
CG	Central Government Hospital (Chittaranjan Cancer)
CGL	E. S. I. Hospital & Occupational Disease (Central)
CMOH	Chief Medical Officer, Health
CTF	Central Treatment Facility
DC	Diagnostic Centre
DEF	Defence Hospital
DENTAL	Dental Hospital
DH	District Hospital
DPL	Durgapur Project Ltd. Hospital
DVC	Damodor Valley Corporation Hospital
ECL	Eastern Coalfield Ltd. Hospital
ESOPD	Extended Special Out Patient Department
GO(N)	Government Nursing Home 477, 1597 (R)
H&FW	Health and Family Welfare
HCU	Health Care Unit
HCWM	Health Care Waste Management
ID	Infectious Diseases Hospital
IIM	Indian Institute of Management
IISCO	Burnpur IISCO Hospital
IOCL	Indian Oil Corporation Hospital
LB	2763, 1583, 4, 600, 1488, 1489 (Municipal) Local Body
MCH	Medical College & Hospital
MNH	Mental Hospital
MUNI	Municipality
NTPC	National Thermal Power Corporation Hospital
ORS	Out Reach Session
PHC	Primary Health Centre
PORT	Port Trust Hospital
PPE	Personal Protective Equipment
Pvt.	Private
R E College	R. E. College Hospital
RH	Rural Hospital
RLY	Central Government Rail Hospital
SAIL	Steel Authority of India Ltd. Hospital
SC	Sub-Centre
SDH	Sub-Divisional Hospital

SEB	State Electricity Board Hospital
SGCI	State Government Cinchona Plantation Hospital
SGE	State Government Educational Hospital
SGH	State General Hospital
SGI	State Government Irrigation Hospital
SGJ	State Government Jail Hospital
SGL	ESI Hospital (State)
SGP	State Government Police Hospital
SGV	State Government Vagrant Home
SGVH	Veterinary Hospital
SUDA	State Urban Development Agency
TB	T B Hospital
VDC	Vaccine Distribution Centre
WBHSDP	West Bengal Health System Development Project
WBPCB	West Bengal Pollution Control Board
WHO	World Health Organisation

Overview

Biomedical waste consists of solids, liquids, sharps, and laboratory waste that are potentially infectious or dangerous. It must be properly managed to protect the general public, specifically healthcare and sanitation workers who are regularly exposed to biomedical waste as an occupational hazard.

Waste generated by health care activities includes a broad range of materials, from used needles and syringes to soiled dressings, body parts, diagnostic samples, blood, chemicals, pharmaceuticals, medical devices and radioactive materials. Disposal of this waste is an environmental concern, as many medical wastes are classified as *infectious* or *biohazardous* and could potentially lead to the spread of infectious diseases and other health concerns.

World Health Organization (WHO) points out that health care wastes and by-products cover a diverse range of materials: (a) Infectious wastes -- cultures and stocks of infectious agents, wastes from infected patients, wastes contaminated with blood and its derivatives, discarded diagnostic samples, infected animals from laboratories, and contaminated materials (swabs, bandages) and equipment (disposable medical devices etc.); and (b) Anatomic - recognizable body parts and animal carcasses.

From the total of waste generated by health-care activities, almost 80 - 85 % is general waste comparable to domestic waste. The remaining approximate 15 - 20% of waste is considered hazardous materials that may be infectious, toxic or radioactive. When all the waste is mixed together, 100% of the waste turns infectious and hazardous as well as become unmanageable.

According to WHO "poor management of health care waste potentially exposes health care workers, waste handlers, patients and the community at large to infection, toxic effects and injuries, and risks polluting the environment. It is essential that all medical waste materials are segregated at the point of generation, appropriately treated and disposed of safely."

According to a very recent report prepared by Indian Institute of Management (IIM), Lucknow, approximately 42,0461 kg per day or approximately 155 thousand MT per year bio-medical waste is generated in India. "Presently, 50-55 per cent of bio-medical waste is collected, segregated and treated as per Bio-medical Waste Management Rules. Rest is dumped with municipal solid wastes," the report says. Out of 84,809 hospitals, only 48,183 are either using common bio-medical waste treatment facilities (which are 170 in number) or have engaged other private agencies.

Background of the Study:

Efforts towards safe and proper management of bio-medical waste in West Bengal date back to the 1990s, even prior to the introduction of the Bio-Medical Waste (Management and Handling) Rules, 1998.

The first initiative extending to the whole of the state was taken by the Health and Family Welfare Department of the Government of West Bengal for management of bio-medical waste in the secondary level (District, Sub-Divisional, State-General and Rural) Government hospitals. With the introduction of the BMW Rules in 1998 WBPCB became the designated authority to approve and monitor the BMW management in the state. The years that followed witnessed establishment of a number of common bio-medical waste treatment facilities with systems of segregated collection, treatment and disposal of bio-medical waste that covers a major part of the state.

Today, after ten years of the introduction of BMW Rules, it is imperative to assess the achievements and the failures, the problems and the prospects of BMW management in West Bengal. The exercise is called for not only to identify the strengths and weaknesses of the efforts but also to indicate requirements and possibilities - indispensable elements for future planning.

Study Objective:

1. Preparation of an Inventory of Health Care Establishments in West Bengal.
2. Quantification of Bio-Medical Waste generated in West Bengal.
3. Assessment of Treatment and Disposal Options of Bio-Medical Waste available and in operation in West Bengal.
4. Requirement and availability of Common Bio-medical Waste Treatment Facilities in West Bengal.
5. Assessment of compliance status of BMW management of selected Health Care Units and Treatment Facilities.
6. Options for management of bio-medical waste of HCUs in remote areas beyond the reach of CBWTFs.

Study Period: November 2008 to March 2010

Scope of Activities:

1. Preparation of a list of Health Care Units (HCUs) operating in the state with capacity [Bed Strength].

2. Preparation of a list of Diagnostic Centres with Number of tests conducted per day.
3. Preparation of a list of BMW Treatment Facilities available in the State as a whole with capacity, coverage and operational status.
4. Review of BMW management practices in some selected HCUs of different categories with a view to develop an assessment of the compliance status.
5. Assessment of BMW generated by category in some selected HCUs and Pathological Laboratories of different categories.
6. Assessment of Total Amount of BMW generated by HCUs and Diagnostic Centres for the State (by district) as a whole.
7. Assessment of requirement and availability of CBWTFs in West Bengal.
8. Comparative Assessment of BMW generated in the coverage areas of respective treatment facilities and actually treated by those.
9. Assessment of recyclables and non-recyclable bio-degradables in the BMW stream.
10. Strategy for BMW management in remote (beyond the reach of CTF) areas.
11. Assessment of Mercury Waste generation and disposal (as mercury waste is specially hazardous, though not included in BMW)

Methodology:

Assessment of Bio-Medical Waste generated with points of generation

- I. Preparation of an inventory of health care units (hospitals, nursing homes and diagnostic centres) operating in the state by category.
- II. Assessment of average quantity of different categories of Bio-Medical Waste (BMW) generated by each category of HCUs.
- III. Projection of total quantity of BMW generated in the state by category by multiplying the average quantity of BMW generated with number of HCUs of each category.
- IV. Assessment of recyclables and non-recyclable bio-degradables in the BMW stream by separate quantification, averaging and computation.

Review of BMW management practices in HCUs and Diagnostic Centres –

- V. Review of selected HCUs of different categories with a view to develop an assessment of the compliance status.

Assessment of Bio-Medical Waste treatment facilities -

- VI. Preparation of an inventory of BMW Treatment Facilities available in the State as a whole with capacity, coverage and operational status.
- VII. Assessment of requirement and availability of CBWTFs in West Bengal through investigation of the capacity and coverage of existing CBWTFs and area specific generation of BMW.
- VIII. Comparative Assessment of BMW generated in the coverage area of treatment facility and actually treated by the treatment facility.

Evolving Options for Bio-Medical Waste management in remote (beyond the reach of CBWTF) areas -

- IX. Options for management of bio-medical waste of HCUs in remote areas through an assessment of available scientific methods and statutory obligations.

Detailed Methodology

Preparation of lists of Health Care Units (HCUs) with capacity [Bed Strength] and Diagnostic Centres with Number of Patients Investigated per day operating in the state.*

The required information was collected through secondary source -

Enlisting of all Health Care Units (Governmental, Municipal and Private) and Diagnostic Centres operating in the state has been a basic requirement for preparation of an Inventory of Health Care Waste generation and disposal. The present study had to depend on **secondary sources** for the same as generation of primary data on number and categories of HCUs and Diagnostic Centres fell beyond its scope.

Private medical clinics, health camps, blood donation camps were kept outside the purview of the study as no comprehensive secondary data were available on their numbers.

Note: The inventory and the estimation of bio-medical waste have been prepared on the basis of the list of HCUs with respective bed strength available with WBPCB in December 2008 (source: Directory of the Health & Family Welfare Department, Govt. of W.B.). Generation of bio-medical waste has been estimated on the basis of bed strength of different categories of HCUs in the said inventory. It has been intimated by WBPCB of late that according to the Deptt. of H&FW a considerable number of Primary Health Centres (PHCs) and some Block Primary Health Centres (BPHCs) and one Rural Hospital in the said list are not generating bio-medical waste. In that case the estimated amount of BMW generated would accordingly be lesser.

Assessment of average quantity of Bio-Medical Waste (BMW) generated in specific HCUs.

Government HCUs

HCUs	Method of Assessment
Large Referral Hospitals [Tertiary]	All BMW generated per day by category by facility for 4 consecutive days. Five Hospitals. Two in South Bengal, Two in Kolkata and one in North Bengal.
District, State General, Sub-Divisional & Rural Hospitals [Secondary]	All BMW generated per day by category by facility for 4 consecutive days. Two hospitals in each category. Eight hospitals in all. One each of each category in South and North Bengal.
Block Primary Health Centres (BPHCs) & Primary Health Centres (PHCs) [Primary]	All BMW generated per day by category by facility for 4 consecutive days. Four Hospitals. Two (BPHC+PHC) each in S. and N. Bengal.
Lowest level Immunisation & Health Care Units [Sub-Centre]	All BMW generated per day by category by facility for 2 consecutive clinic days. Two SCs. One each in South and North Bengal
Specialty Hospitals	7 Specialty Hospitals having different types of health care facilities. One of each type.

Municipal HCUs

HCUs	Method of Assessment
Hospital	All BMW generated per day by category by facility for 4 consecutive days. Two Hospitals. One each in South and North Bengal
Maternity Unit	All BMW generated per day by category by facility for 4 consecutive days. Two Hospitals. One each in South and North Bengal
Extended Special Out-Patient Department (ESOPD)	All BMW generated per day by category by facility for 4 consecutive days. Two Clinics. One each in South and North Bengal
Immunisation Centres (SC)	All BMW generated per day by category by facility for 3 consecutive clinic days. Two Units. One each in South and North Bengal

Private HCUs and Pathological Laboratories

HCUs	Method of Assessment
Private Hospitals : Very Large: 300+ beds; Large:100+ to 300 beds; Medium: 50+ to 100 beds; Small : Up to 50 beds	All BMW generated per day by category by facility for 4 consecutive days. Four Hospitals. One of each Category.
Pathological Laboratories: Large : 2000 Tests / month Medium : 500 " Small : 250 "	All BMW generated per day by category by facility for 4 consecutive days. Three Path Labs. One of each Category.

Review of BMW management practices in HCUs and Diagnostic Centres

Survey of all specified units on nodal areas of biomedical waste management – Collection; Storage; Treatment and Disposal.

HCUs	Number	HCUs	Number
MCH	8	Govt Sub-Centre	2
DH	17	Municipal Hospital	2
SDH	2	Maternity Hospital	2
SGH	2	ESOPD	2
RH	2	Municipal Sub-Centre	2
BPHC	2	Private Hospital	4
PHC	2	Specialty Hospital	6

Assessment of Bio-Medical Waste treatment facilities

Facilities	Method
Number of Common Bio-medical Waste Treatment Facilities with coverage area; estimated and actual quantity of treated waste; operational status.	System functioning assessment through review of records. Comparing quantity of BMW generated in coverage area with actual quantity of treated waste.
Number of Stand Alone Treatment Facilities with coverage; estimated and actual quantity of treated waste; operational status.	System functioning assessment through records. Comparing quantity of BMW generated in covered unit with actual quantity of treated waste.

Options for BMW management in remote (beyond the reach of CTF) areas

Issue	Method
Some areas may be so remote as to be out of reach for direct hauling or generation of BMW is so small that transporting BMW to CBWTFs is cost prohibitive.	Developing special strategy options for BMW management applying available scientific methods, complying statutory obligations and utilizing facilities.

Assessment of generation of mercury waste particularly from broken thermometers and develop suggestions to address the problem.

Issue	Method
Thermometers are regularly consumed in HCUs and new thermometers are procured.	Collection of data from bedded HCUs on average procurement of mercury thermometers in each category of HCUs and calculate approximate amount of spillage.

Project Team

DISHA Research Team

Project Director

Sasanka Dev

Project Coordinator

Pradip Chatterjee

Project Associates

***Shyamalendu Biswas, Nailambar Bhuinya, Subimal chatterjee,
Bidhan Chandra Dey, Swapan Mullick, Salim Mullick, Rakesh Ghosh,
Milan Mondal, Mark Engineer***

WBPCB Monitoring Team

Prof. Shyamal Sanyal, Advisor

Dr. Dipak Chacrabarty, Chief Scientist

Dr. Tapas Kumar Gupta, Chief Engineer

***Shyamal Kr. Adhikari, Sr. Environmental Engineer,
Waste Management Cell***

Debashis Sarkar, Sr. Environmental Engineer, Planning

Sharmistha Kundu, Environmental Engineer, Waste Management Cell

Quazi Quamarul Hasan, Environmental Engineer, Planning

**INVENTORY OF SOURCES
OF
BIO-MEDICAL WASTE**

Introduction

Bio-Medical waste is generated at various places viz., hospitals, nursing homes, maternity homes, basic level health care centres, immunization centres, diagnostic centres, blood banks, health camps, blood donation camps, institution laboratories, doctors' chambers, pharmacies and even households. All these sources come under the purview of Bio-Medical Waste (Management and Handling) Rules 1998. However the present study did not have the scope to assess BMW generation from all these sources. The study mainly concentrated on health care units (HCUs) like hospitals, nursing homes, maternity homes, basic level health care centres, immunization centres, diagnostic centres etc. Health camps, blood banks, blood donation camps, laboratories attached to institutions, doctors' chambers, pharmacies and households have been excluded from the purview of this study.

Objective of preparation of Inventory

One of the nodal tasks of the present study has been an assessment of the amount of BMW generated in the above mentioned categories of HCUs in West Bengal. The first step towards assessment of Bio-Medical Waste generated in a state necessarily calls for preparation of an inventory of the HCUs under study **by category**.

This study endeavours to estimate the amount of BMW generation in each district of the state *by first dividing all the HCUs in a number of categories* in such a manner so that the amount of BMW generated per bed per day (in bedded HCUs) or per patient per day (in non-bedded HCUs) in each of the HCUs belonging to a particular category are more or less same and may be reasonably averaged out. Thus, for bedded units, the *total amount* of BMW generated by HCUs belonging to that category may be computed by *multiplying the average quantity* of BMW generated per bed per day with total number of beds in HCUs of that category. For non-bedded units, average BMW generated in one HCU of one category is multiplied by *total number* of HCUs in that category to arrive at total generation. Finally, the *quantities of BMW generated by different categories* of HCUs in a district are *added* to get the *total quantity of BMW* generated in that district and thus as a whole in the state.

Categorization of HCUs

[See 'Layout for Inventorisation of Health Care Units' at page Inventory 5]

Methodology

Step 1 : The health care units (HCUs) in the state have first been categorized as bedded and non-bedded facilities.

It is obvious that there is large difference in BMW generation, by both quantity and quality, between bedded and non-bedded health care facilities.

Step 2 : Next, the bedded facilities are further subdivided as in the following –

i) Government General: Includes the general stream of State Government HCUs, i.e. Medical College & Hospitals, District Hospitals, Sub-Divisional Hospitals, State General Hospitals, Rural Hospitals, Block Primary Health Centres and Primary Health Centres.

HCUs, belonging to each category of hospitals mentioned above may be reasonably taken to generate average quantity of BMW per bed per day.

ii) Other Government: Other Government Hospitals of general character like hospitals belonging to Steel Authority of India (SAIL), Port Trust of India, Eastern Coalfield Limited, Railways, State Electricity Board, Jail, ESI etc. are included in this category.

It is observed that the services catered by these HCUs are more or less similar to those of government HCUs in the general stream mentioned above. It is also presumed and later validated by the present quantification study that in these hospitals BMW generation per bed per day varies according to their bed strengths. As such the BMW generated per bed per day in each of these hospitals are taken as the BMW generated per bed per day in a Government General hospital belonging to a category of comparable bed strength.

iii) Municipality: Municipal bedded health care units are of two kinds, general hospitals and maternity homes.

The general municipal hospitals can be reasonably taken to generate BMW per bed per day as the HCUs belonging to categories with similar ranges of bed strengths. However, Municipal Maternity Homes constitute a different category of hospitals both in terms of the services catered and, eventually, the quality and quantity of BMW generated.

iv) Specialty: These hospitals, both government and private, exclusively cater to patients with specific diseases like Infectious Diseases (ID), Tuberculosis (TB), Leprosy, Cancer, Eye Disorders and Dental problems.

The specific and exclusive character of health care services provided by hospitals belonging to these categories cause differences in the quality and quantity of BMW generated.

v) Private: Private hospitals and nursing homes belong to this category. Generally BMW generation in private HCUs vary from that in government HCUs because of administrative and health care practices typical to those. But among the private HCUs also, BMW generation per bed per day varies with the range of bed strength to which they belong. As such range of bed strength has been taken for an indicator of average quantity of BMW generated and private hospitals and nursing homes are categorized according to the ranges of bed strengths they belong to.

Step 3 : Likewise, the non-bedded facilities are also further subdivided as in the following –

i) Government (Rural and Urban): Non-Bedded Government **Rural and Urban** HCUs mainly include Sub-Centres (SC) and out-reach immunization sessions.

ii) Municipality (Urban): Municipal non-bedded HCUs are mainly constituted of Municipal Sub-Centres (SC) and Extended Special Out Patient Departments (ESOPD).

iii) Private: All sorts of diagnostic centres with pathological laboratories, X-Ray, ECG, EEG, MRI, Scan etc. belong to this category. Other members in this category are doctors' clinics, eye clinics etc. Pathological Laboratories are the main generators of BMW in this category. It is also obvious that the quality and quantity of BMW generated in Pathological Laboratories differ according to the nature and number of tests done.

As such assessment of BMW generated in pathological laboratories necessitate categorization of pathological laboratories according to the nature and number of tests done.

Source of Primary and Basic Data:

Generation of primary and basic data (number, organization, bed strength, services catered etc.) regarding the HCUs operating in the state has been beyond the scope of the present study. As such the present study had to depend on authentic secondary sources for the required information as in the following:

<i>Information regarding -</i>	<i>Source of Information -</i>
District wise bedded HCUs (Govt., Municipality and Private)	: WBPCB and H & FW Deptt.
District wise non-bedded HCUs (Govt. and Private)	: WBPCB and H & FW Deptt.
District wise non-bedded HCUs (Municipality)	: State Urban Development Agency (SUDA), West Bengal

Lay-Out for Inventory of Health Care Units

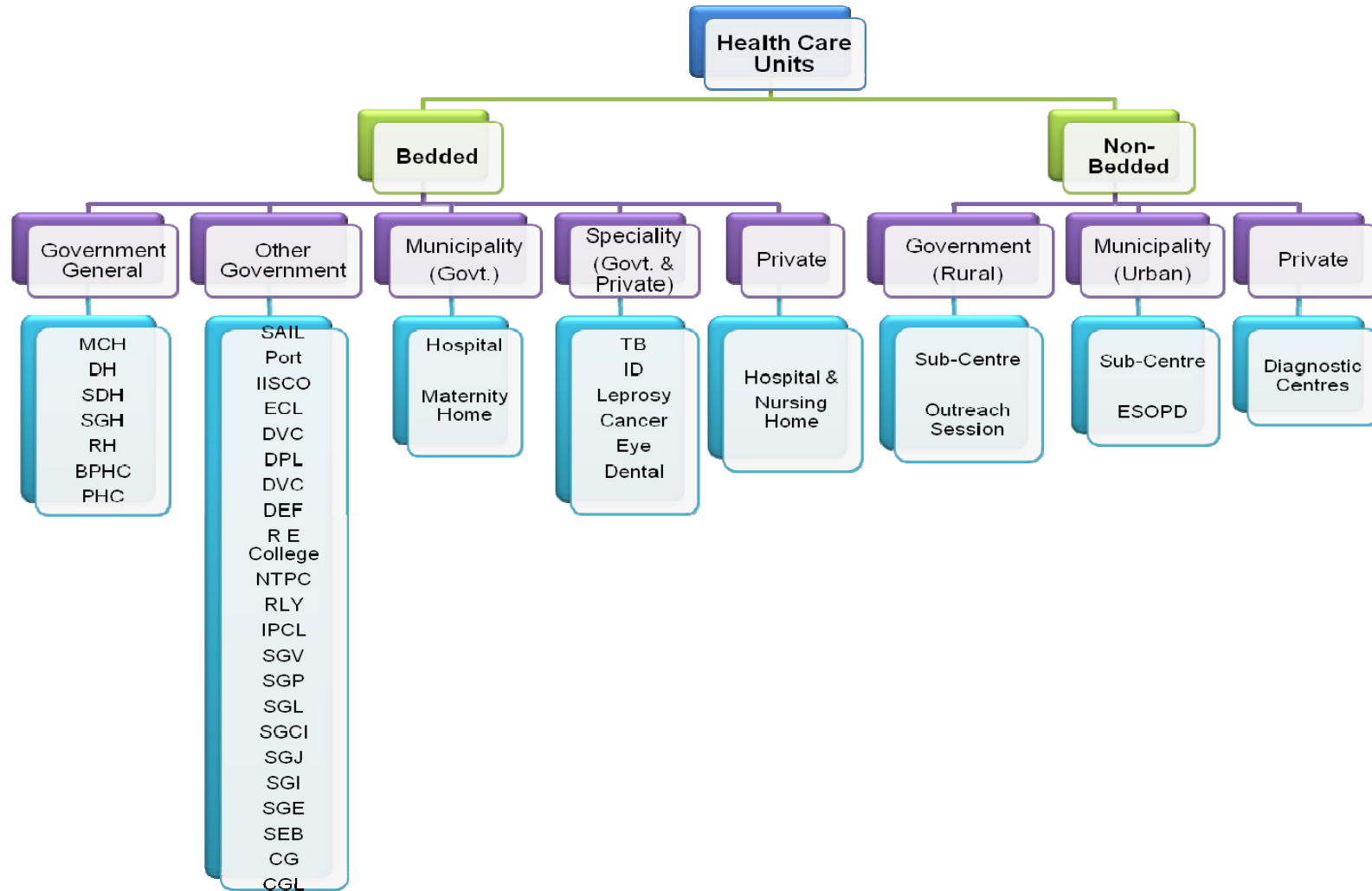

Data Processing:

The primary data was subjected to a process of compilation and collation to generate the following products:

§ Bedded HCUs

- I. District wise list of bedded HCUs of both General and Special Categories with Name, Address, Current Bed Strength, Organisation (Govt., Municipal and Pvt.).
- II. Government Bedded HCU data broadsheet giving numbers and total bed strengths of each category of HCUs in each district and the state as a whole.
- III. District wise distribution of all bedded HCUs by category giving number of HCUs in each category with their total bed strengths.

§ Non-Bedded HCUs

- IV. District wise list of non-bedded HCUs –
 - a. Diagnostic Centres with Name, Address and services catered.
 - b. Rural and Urban Non-Bedded HCUs (Sub-Centres and Outreach Immunisation Sessions – total number in a district).
 - c. Urban (Municipal) Non-Bedded HCUs (Sub-Centres and Extended Special Out Patient Departments - total number in a district).
- V. District wise Diagnostic Centre data master giving all kinds of diagnostic centres available in each district and the state as a whole.

Constraints:

A) Comprehensibility of primary data: The comprehensibility of primary data regarding the list of health care units collected from secondary sources could not be verified as it was beyond the scope of the present study. But some obvious omissions* in the primary data very reasonably leads one to doubt its comprehensibility. In all probabilities the primary data used in the study bear chances of leaving out some health care units. It is hoped that future studies will be enabled by more comprehensive primary data.

B) Inability to categorize pathological laboratories by nature and number of tests undertaken: Categorization of pathological laboratories by nature (variety of tests done) and number of tests undertaken could not be done as no such data was available.

This constraint eventually *makes it almost impossible to assess the quantity of Bio-Medical waste generated from the pathological laboratories operating in the state* because quantity of Bio-Medical waste generated in a pathological laboratory depends on the nature and number of tests undertaken by it.

In view of the above the only way left, with probability of larger margin of error, is to attempt a provisional assessment basing oneself on some primary presumptions regarding categorization of Pathological Laboratories on the basis of the number and nature of tests done.

* A few examples of obvious omissions: a. Central Blood Bank, Manicktala; b. Only 17 Pathological Laboratories in Malda District; c. Only 12 Pathological Laboratories in Dakshin Dinajpur District, d. Only 1 Veterinary Hospital in the state.

Summary Findings

❧ Bedded HCUs in West Bengal*

Sl No.	Category	Number of HCUs	Number of Beds
i	Government General	1,392	45,457
ii	Other Government (Other than Specialty)	132	11,850
iii	Municipality (General & Maternity)	55	1,413
iv	Private (Other than Specialty)	2,036	36,513
v	Specialty (Both Government & Private)	165	7,716

❧ Non-bedded HCUs in West Bengal

Sl No.	Category	Number
i	Government Sub-Centres (Rural)	10,356
ii	Government Sub-Centres (Urban)	2,100
iii	Municipal Sub-Centres	1,740
iv	Municipal OPDs	48

**It may be mentioned here once again that the inventory and the estimation of bio-medical waste have been prepared on the basis of the list of HCUs with respective bed strength available with WBPCB in December 2008. Generation of bio-medical waste has been estimated on the basis of bed strength of different categories of HCUs in the said inventory. It has been intimated by WBPCB of late that according to the Deptt. of H&FW a considerable number of HCUs in the said list are not generating bio-medical waste. In that case the estimated amount of BMW generated would accordingly be lesser.*

I. District wise list of bedded HCUs with Name, Address, Current Bed Strength, Organisation (Govt., Municipal and Pvt.), General and Special Categories.

Detailed District wise list of bedded HCUs with Name, Address, Current Bed Strength, Organisation (Govt., Municipal and Pvt.), including both General and Special Categories is placed at **INVENTORY: ANNEXURE - I**

However, summary reports giving out at a glance assessment of total number of HCUs and their bed strengths distributed among different districts of West Bengal are placed below:

A. District Wise Number of Government and Private Bedded HCUs with Number of Beds in West Bengal:

District	Number of Bedded HCUs			Number of Beds in HCUs		
	Private	Government	Total	Private	Government	Total
Hooghly	206	99	305	3169	3544	6713
Howrah	152	79	231	1898	3066	4964
Purulia	13	82	95	727	1676	2403
Burdwan	214	171	385	3557	6353	9910
Bankura	49	101	150	763	3011	3774
Birbhum	48	86	134	446	2121	2567
Darjeeling	78	51	129	1718	3082	4800
Uttar Dinajpur	18	35	53	229	615	844
Jalpaiguri	53	62	115	896	1755	2651
Coochbehar	22	49	71	531	1385	1916
Dakshin Dinajpur	7	30	37	106	715	821
Malda	23	58	81	378	1404	1782
Nadia	88	80	168	1295	5224	6519
North 24 Pgs.	296	123	419	4894	4693	9587
South 24 Pgs.	181	107	288	1890	1943	3833
Murshidabad	91	116	207	975	3186	4161
East Midnapore	124	89	213	1336	1445	2781
West Midnapore	151	129	280	1493	3389	4882
Kolkata	368	51	419	12603	15438	28041
TOTAL	2182	1598	3780	38904	64045	102949

District-Wise Number of Government and Private Bedded HCUs with Total Bed Strengths in West Bengal

Total number of bedded HCUs in West Bengal is 3780, of which private HCUs are 2182 and government HCUs are 1598.

Total number of beds in these HCUs are 102949, of which 38904 beds belong to private HCUs and the rest 64045 to government HCUs.

By number of HCUs - total, private and government, Dakshin Dinajpur district claims the lowest - 37, 7 and 30 respectively.

By number of Beds - total, private and government, Dakshin Dinajpur district claims the lowest in total and private - 821 and 106 respectively. While Uttar Dinajpur has the lowest (615) number of government HCU beds.

As expected, number of bedded HCUs in Kolkata is 419, the highest among districts, but the district of North 24 Parganas also has the same number of bedded HCUs. The dissimilarity between these two districts is due to the concentration of large government and private HCUs in Kolkata that results in a staggering difference in number of beds. Kolkata accounts for a total of 28,041 beds, of which 15,438 beds belong to 51 government HCUs and 12,603 beds belong to 368 private HCUs while North 24 Parganas accounts for a total of 9,587 beds, of which 4,693 beds belong to 123 government HCUs and 4,894 beds belong to 296 private HCUs

By range of number of bedded HCUs the districts of Dakshin Dinajpur, Uttar Dinajpur, Coochbehar, Malda and Purulia belong to the lowest (below 100). The districts of Jalpaiguri, Darjeeling, Birbhum, Bankura, Murshidabad, Nadia, East Midnapore, Howrah, West Midnapore and South 24 parganas belong to the middle range (101 to 300). The highest range (301 to 500) has the districts of Hooghly, Burdwan, North 24 Parganas and Kolkata.

DISTRICTS BY RANGE OF NUMBER OF HCUs	
Range by Number of HCUs	Districts
Below 100	Dakshin Dinajpur, Uttar Dinajpur, Coochbehar, Malda, Purulia.
101 to 300	Jalpaiguri, Darjeeling, Birbhum, Bankura, Murshidabad, Nadia, East Midnapore, Howrah, West Midnapore, South 24 parganas.
301 to 500	Hooghly, Burdwan, North 24 Parganas, Kolkata.

By range of number of beds the districts of Dakshin Dinajpur and Uttar Dinajpur belong to the lowest (below 1000). The districts of Malda, Coochbehar, Purulia, Birbhum, Jalpaiguri, East Midnapore, Bankura, South 24 parganas, Murshidabad, West Midnapore, Darjeeling and Howrah are in the next range (1001 to 5000). The next higher range (5001 to 10000) has in it the districts of Nadia, Hooghly, North 24 Parganas and Burdwan. It is interesting to note that no district belong to the next higher range (10001 to 20000). The highest range (above 20000) has Kolkata as the lone district belonging to it.

DISTRICTS BY RANGE OF NUMBER OF BEDS	
Range by Number of Beds	Districts
Below 1000	Dakshin Dinajpur, Uttar Dinajpur.
1001 to 5000	Malda, Coochbehar, Purulia, Birbhum, Jalpaiguri, East Midnapore, Bankura, South 24 parganas, Murshidabad, , West Midnapore, Darjeeling, Howrah.
5001 to 10000	Nadia, Hooghly, North 24 Parganas, Burdwan.
10001 to 20000	
Above 20000	Kolkata.

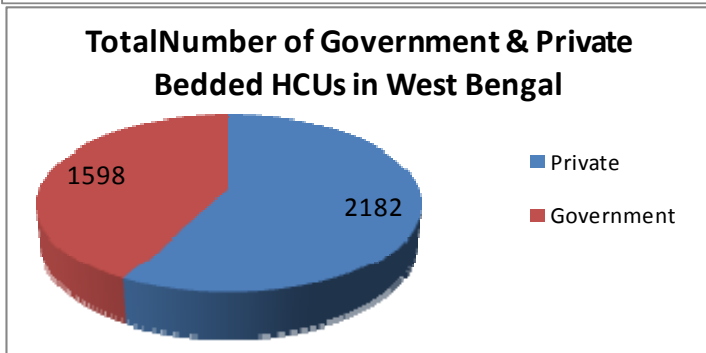
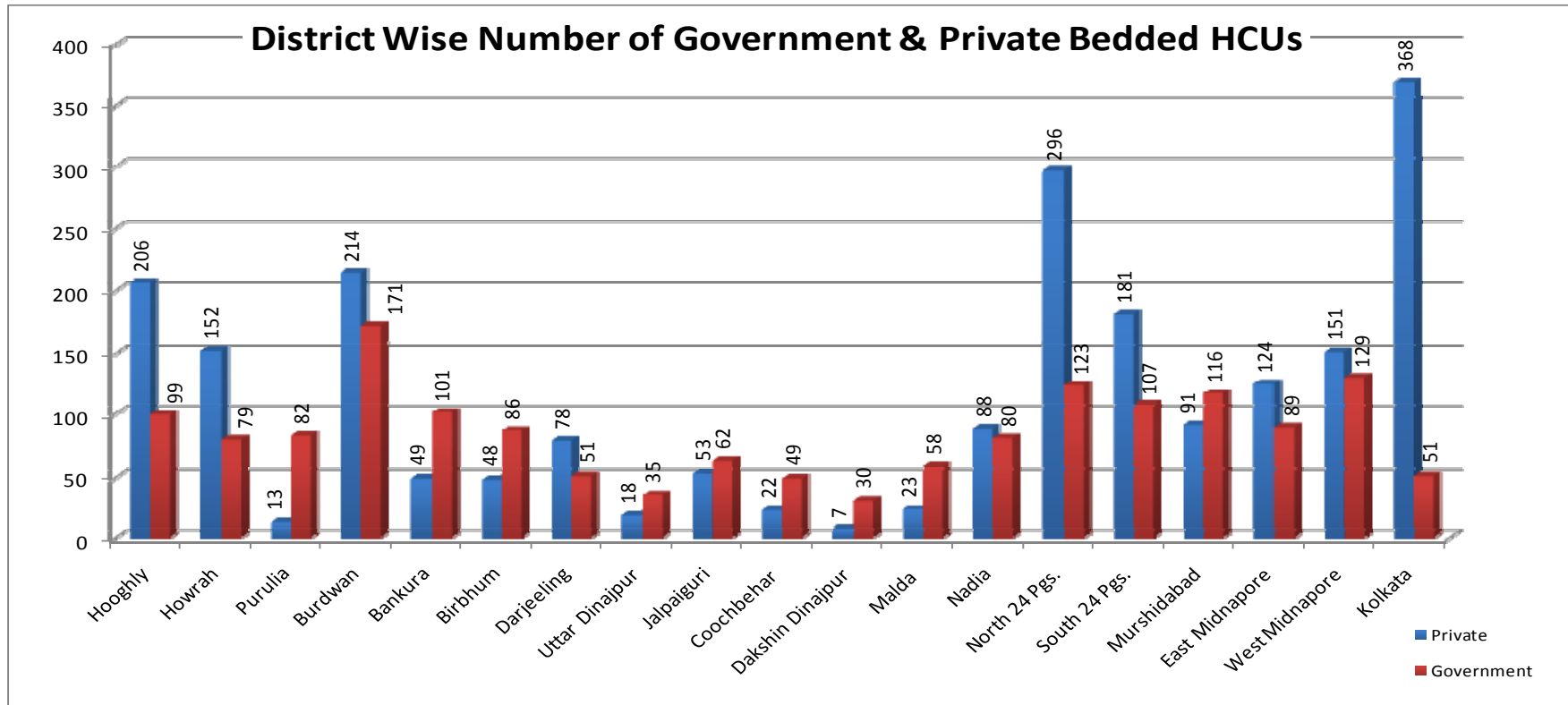

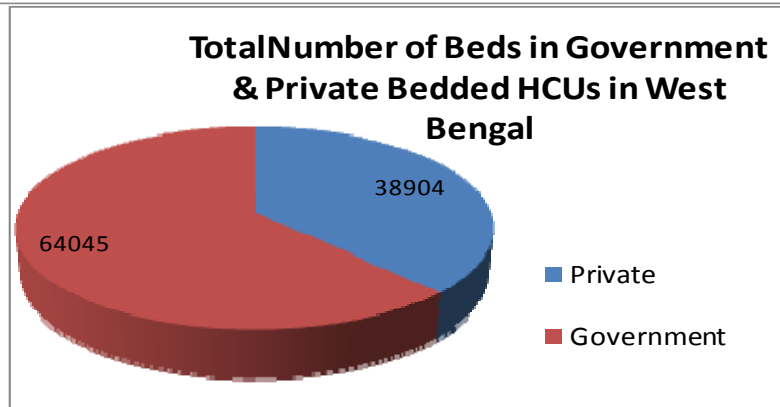
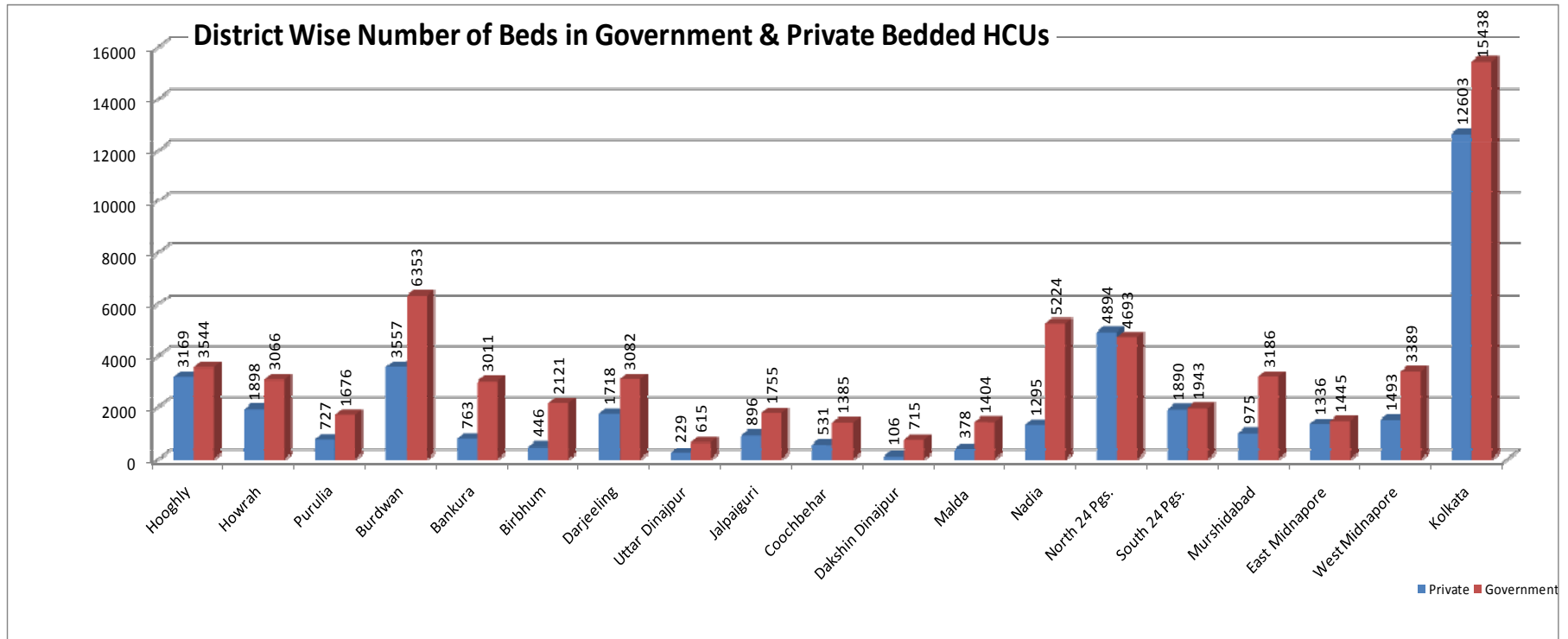

II. Government Bedded HCU data broadsheet giving numbers and total bed strengths of each category of HCUs in each district and the state as a whole.*

A broadsheet presentation of data related to government bedded HCUs have been called for due to their large number and wide variation.

A total of 1598 government bedded HCUs of 37 different categories with 64045 beds are presented in the broadsheet with numbers of HCUs of each category in each district along with their respective total bed strengths.

Short forms used for categories of HCUs has been provided in the list of abbreviations.

* This broadsheet has been prepared on the basis of the list of HCUs available with WBPCB in December 2008 and in accordance with the categories specified therein.

BROADSHEET PRESENTATION FOR GOVERNMENT BEDDED HCUs BY DISTRICT & BY CATEGORY*

DISTRICT	Hooghly		Howrah		Purulia		Burdwan		Bankura		Birbhum		Darjeeling		Uttar Dinajpur		Jalpaiguri		Cooch behar		Dakshin Dinajpur		Malda		Nadia		North 24 Pgs.		South 24 Pgs.		Murshidabad		East Midnapore		West Midnapore		Kolkata		Total									
	No.	Bed	No.	Bed	No.	Bed	No.	Bed	No.	Bed	No.	Bed	No.	Bed	No.	Bed	No.	Bed	No.	Bed	No.	Bed	No.	Bed	No.	Bed	No.	Bed	No.	Bed	No.	Bed	No.	Bed	No.	Bed	No.	Bed	No.	Bed								
MCH							1	1099	1	1217			1	1000																																		
DH	1	540	1	544	1	500					1	500	2	628	1	168	1	610	1	400	1	300	1	600	2	895	1	500			1	391	1	336			1	600	17	7512								
SDH	3	766	1	210	1	68	4	770	2	245	2	411	2	470	1	68	2	325	4	520	1	120			2	186	4	750	4	361	5	789	3	299	3	672			44	7030								
SGH	1	204	8	544																			1	30	6	1286	10	974	1	15	2	245	1	50			20	3124	54	7292								
RH	8	320	6	240	6	180	7	300	6	210	4	170	3	110	1	30	5	165	1	30	1	25	6	238	7	240	8	265	9	345	10	380	3	85	9	345			100	3678								
BPHC	9	121	9	110	15	225	29	415	17	326	15	310	8	150	7	161	8	115	10	115	6	110	9	135	7	95	15	204	18	227	18	314	21	282	20	265			241	3680								
PHC	60	395	41	254	54	242	103	571	70	386	58	346	21	108	23	128	38	198	29	158	19	80	36	219	49	360	52	302	65	373	70	426	55	301	84	446			927	5293								
DENTAL																																																
ID				1	52																																											
MNH					1	200																																										
GO(N)																																																
SG(O)																																																
MUNI	7	253	2	29									1	17	1	10																																
TB	1	55										1	300	1	334			1	60							2	1803	1	94																			
LB			1	35										1	24																																	
CGL																																																
CG	1	30								1	50	1	50														1	10	1	45																		
SEB	1	10			1	10																																										
SGE			1	24										1	40																																	
SGI										1	7	1	2																																			
SGJ	1	27	1	6	1	33	2	55	1	8	1	10	2	24																																		
SGCI												4	55																																			
SGL	3	718	3	616			1	85																																								
SGP	1	99	1	104	1	20	1	44	1	12	1	20	1	50	1	50	1	28	1	20	1	50	1	27	1	46	1	120																				
SGV	1	2	1	18																																												
IOCL																																																
RLY	1	4	2	280	1	198	4	472			1	2	2	22			3	115	1	2			1	100			2	224																				
NTPC																																																
R E College							1	6																																								
DEF							1	40																																								
DPL							1	106																																								
DVC							1	30																																								
ECL							11	1120																																								
IISCO							1	550																																								
AMBH							2	100																																								
PORT																																																
SAIL							1	590																																								
TOTAL	99	3544	79	3066	82	1676	171	6353	101	3011	86	2121	51	3082	35	615	62	1755	49	1385	30	715	58	1404	80	5224	123	4693	107	1943	116	3186	89	1445	129	3389	51	15438	1598	64045								

* Categories are as given in the list of HCUs available with WBPCB.

III. District-wise distribution of bedded HCUs by category giving number of HCUs in each category with their total bed strengths.

The bedded HCUs in the general list were further scrutinised and categorised as enunciated in Step-2 of the methodology (see page Inventory 3) to get –

- A. District wise distribution of general category of government bedded HCUs, i.e., MCH, DH, SDH, RH, BPHC and PHC.
- B. District wise distribution of other government bedded HCUs by the following categories –
 - i. HCUs with less than 50 beds (to be approximated with BPHCs for quantification of BMW)
 - ii. HCUs with 50 to 100 beds (to be approximated with RHs for quantification of BMW)
 - iii. HCUs with 101 to 300 beds (to be approximated with SGHs for quantification of BMW)
 - iv. HCUs with more than 300 beds (to be approximated with DHs for quantification of BMW)
- C. District wise distribution of private bedded HCUs by following categories –
 - i. HCUs with less than 50 beds
 - ii. HCUs with 50 to 100 beds
 - iii. HCUs with 101 to 300 beds
- D. District wise distribution of municipal bedded HCUs by following categories –
 - i. Municipal General Hospitals
 - ii. Municipal Maternity Homes
- E. District wise distribution of specialty bedded HCUs by following categories –
 - i. Eye Hospitals
 - ii. Dental Hospitals
 - iii. Infectious Disease (ID) Hospitals
 - iv. Leprosy Hospitals
 - v. Cancer Hospitals
 - vi. TB Hospitals

This division into categories directly relates to the requirement of quantification of BMW generated in the bedded HCUs.

A. District-wise Distribution of Bedded HCUs by Category with Bed Strength

HCU	Bankura		Birbhum		Burdwan		Coochbihar		Dakshin Dinajpur		Darjeeling		East Midnapore		Hooghly		Howrah		Jalpaiguri			
	No.	Bed	No.	Bed	No.	Bed	No.	Bed	No.	Bed	No.	Bed	No.	Bed	No.	Bed	No.	Bed	No.	Bed		
Government																						
MCH	1	1217			1	1099					1	1000										
DH			1	500			1	400	1	300	2	628	1	336	1	540	1	544	1	610		
SDH	2	245	2	411	4	770	4	520	1	120	2	470	3	299	3	766	1	210	2	325		
SGH	1*	550*					1	120			1	50	3	60	1	204	8	544	1	100		
RH	6	210	4	170	7	300	1	30	1	25	3	110	3	85	8	320	6	240	5	165		
BPHC	17	326	15	310	29	415	10	115	6	110	8	150	21	282	9	121	9	110	8	115		
PHC	70	386	58	346	103	571	29	158	19	80	21	108	55	301	60	395	41	254	38	198		
Other Government																						
< 50 Beds (#BPHC)	3	27	4	34	10	275	3	42		50	9	141	3	82	4	43	3	48	5	71		
50 - 100 Beds (#RH)	1	50	1	50	7	385			1		1	50			1	99						
> 101 - 300 Beds (#SGH)					4	798									3	718	6	1000	1	111		
> 300 Beds (#DH)					3	1590																
Private																						
Small (< 50 Beds)	46	470	43	405	191	2420	17	296	7	106	66	1013	121	1116	189	2182	138	1493	52	871		
Medium (50 - 100 Beds)					9	529	3	210			6	400	2	200	8	561	1	50				
Large (101 - 300 Beds)	1	120			3	468					1	200			2	326	2	265				
Very Large (> 300 Beds)																						
Municipality																						
Hospital	0		0		0		0		0	30	1	24	0		1	40	1	35	0			
Maternity Homes	0		0		0		0		1		1	17	0		6	213	2	29	0			
Speciality Hospitals																						
Eye*	1	5	5	41	8	70	1	10			4	95	1	20	7	100	10	42	1	25		
Dental*																						
Infectious Disease																	1	52				
Leprosy	2	718			2	100																
Cancer					3	70	1	15			1	10			1	30						
TB			1	300	1	50					1	334			1	55	1	48	1	60		
TOTAL A	150	3774	134	2567	385	9910	71	1916	37	821	129	4800	213	2781	305	6713	231	4964	115	2651		

Approximated with

* Dedicated for Leprosy

B. District-wise Distribution of Bedded HCUs by Category with Bed Strength

HCU	Kolkata		Malda		Murshidabad		Nadia		North 24 Parganas		Purulia		South 24 Parganas		Uttar Dinajpur		West Midnapore	
	No.	Bed	No.	Bed	No.	Bed	No.	Bed	No.	Bed	No.	Bed	No.	Bed	No.	Bed	No.	Bed
Government																		
MCH	6	7745															2	611
DH	1	600	1	600	1	391	2	895	1	500	1	500			1	168		
SDH					5	789	2	186	4	750	1	68	4	361	1	68	3	672
SGH	18	2994	1*	30*	2	245	6	1286	10	974			1	15				
RH			6	238	10	380	7	240	8	265	6	180	9	345	1	30	9	345
BPHC			9	135	18	314	7	95	15	204	15	225	18	227	7	161	20	265
PHC			36	219	70	426	49	360	52	302	54	242	65	373	23	128	84	446
Other Government																		
< 50 Beds (BPHC)	4	101	3	64	4	56	3	89	6	134	3	63			1	50	4	94
50 - 100 Beds (RH)	4	226	1	100	4	230			1	100							2	149
> 101 - 300 Beds (SGH)	4	776					1	250	3	465	2	398	2	510			1	130
> 300 Beds (DH)	3	1186			1	350			1	325							1	340
Private																		
Small (< 50 Beds)	284	4144	21	313	87	796	73	921	240	2634	7	75	166	1220	15	169	142	1280
Medium (50 - 100 Beds)	28	1927	1	60	1	50			18	1125			5	335	1	50	2	150
Large (101 - 300 Beds)	21	3755			1	104	2	305	4	681	1	250	2	270				
Very Large (> 300 Beds)	6	2198																
Municipality																		
Hospital	0		0		0		0		14	395	0		4	68	0		1	10
Maternity Homes	7	260	1	18	1	5	1	20	7	185	0		4	44	1	10	1	10
Speciality Hospitals																		
Eye*	26	219	1	5	2	25	13	69	30	231	1	5	8	65	2	10	6	53
Dental*	1	100																
Infectious Disease	1	780																
Leprosy	1	70							1	173	4	397					1	10
Cancer	2	460							3	50								
TB	2	500	1	30			2	1803	1	94							1	317
TOTAL B	419	28041	81	1782	207	4161	168	6519	419	9587	95	2403	288	3833	53	844	280	4882

Approximated with

* Dedicated for TB

Bedded HCUs by Category with Bed Strength in West Bengal		
	TOTAL WEST BENGAL	
HCU	No.	
Government		
MCH	11	11672
DH	17	7512
SDH	44	7030
SGH	52	6592
RH	100	3678
BPHC	241	3680
PHC	927	5293
TOTAL GOVERNMENT	1392	45457
Other Government		
< 50 Beds (#BPHC)	72	1464
50 - 100 Beds (#RH)	24	1439
> 101 - 300 Beds (#SGH)	27	5156
> 300 Beds (#DH)	9	3791
TOTAL OTHER GOVERNMENT	132	11850
Private		
Small (< 50 Beds)	1905	21924
Medium (50 - 100 Beds)	85	5647
Large (101 - 300 Beds)	40	6744
Very Large (> 300 Beds)	6	2198
TOTAL PRIVATE	2036	36513
Municipality		
Hospital	22	602
Maternity Homes	33	811
TOTAL MUNICIPAL	55	1413
Specialty Hospitals		
Eye*	127	1090
Dental*	1	100
Infectious Disease	2	832
Leprosy	11	1468
Cancer	11	635
TB	13	3591
TOTAL SPECIALTY	165	7716
TOTAL WEST BENGAL	3780	102949

Approximated with

too stark to be overlooked. There are only two ID hospitals – one in Kolkata and another in Howrah, and only one Dental hospital in Kolkata in the whole of the state.

Society for Direct Initiative for Social & Health Action (DISHA)

Overview

The state of West Bengal has a total of **102949** beds in all its health care units.

Out of this the general government chain of HCUs, i.e., MCH, DH, SDH, SGH, RH, BPHC, PHC provide for **45,457** beds. Other government hospitals provide for **11,850** beds. Private HCUs have a total of **36,513** beds. Total bed strength of Municipal HCUs is **1,413**. And specialty hospitals like Eye, Dental, ID (Infectious Diseases), Leprosy, Cancer and TB bear a total bed strength of **7,716**.

It is worthwhile to mention that the chain of government rural bedded HCUs, i.e., RHs, BPHCs and PHCs muster total bed strength of **12,651**, which is **27.83%** of the total bed strength of general government chain of HCUs and **12.28%** of the total number of beds in West Bengal. This has got important implications for BMW management in the state.

It is also worthwhile to mention that small (bed < 50) private HCUs muster total bed strength of **21,924**, which is **60.04%** of the total bed strength of private HCUs and **21.29%** of the total number of beds in West Bengal. This too has got important implications for BMW management in the state.

The inadequacy of ID and Dental hospitals, in number of units, number of beds and distribution over districts is

IV. District wise list of non-bedded HCUs -

- a. Diagnostic Centres with Name, Address and Services catered.
- b. Rural and Urban Non-Bedded HCUs (Sub-Centres and Outreach Immunisation Sessions - total number in a district).
- c. Urban (Municipal) Non-Bedded HCUs (Sub-Centres and Extended Special Out Patient Departments - total number in a district).

a. Diagnostic Centres with Name, Address and Services catered -

Detailed district wise list of Diagnostic Centres with Name, Address and Services catered is given at **INVENTORY: ANNEXURE - II**. However salient features are given here. There are 3,169 Diagnostic Centres of 47 different categories in the state. Before presenting them in a broad sheet (at the end of the chapter) it is to be mentioned that all the diagnostic centres do not generate BMW. BMW is generated mainly from pathological centres. So an account of pathological centres is placed here.

District Wise Number of Pathological Laboratories																			
Hooghly	Howrah	Purulia	Burdwan	Bankura	Birbhum	Darjeeling	Uttar Dinajpur	Jalpaiguri	Coochbehar	Dakshin Dinajpur	Malda	Nadia	North 24 Pgs.	South 24 Pgs.	Murshidabad	East Midnapore	West Midnapore	Kolkata	Total
329	146	38	140	72	103	57	48	104	50	12	17	186	312	93	118	116	151	480	2572

There is wide variation in the number of pathological laboratories in different districts - from 12 in Dakshin Dinajpur to 480 in Kolkata. [As stated earlier, only 12 and 17 path-labs enlisted in Dakshin Dinajpur and Malda districts ask for re-examination and verification]

Hooghly district accounts for next highest number (329) of path-labs after Kolkata followed by North 24 Parganas (316).

As mentioned earlier, a significant constraint of the present study has been non-availability of data regarding the nature and number of tests done in the pathological laboratories.

b. Rural and Urban Non-Bedded HCUs (Sub-Centres and Outreach Immunisation Sessions – total number in a district).

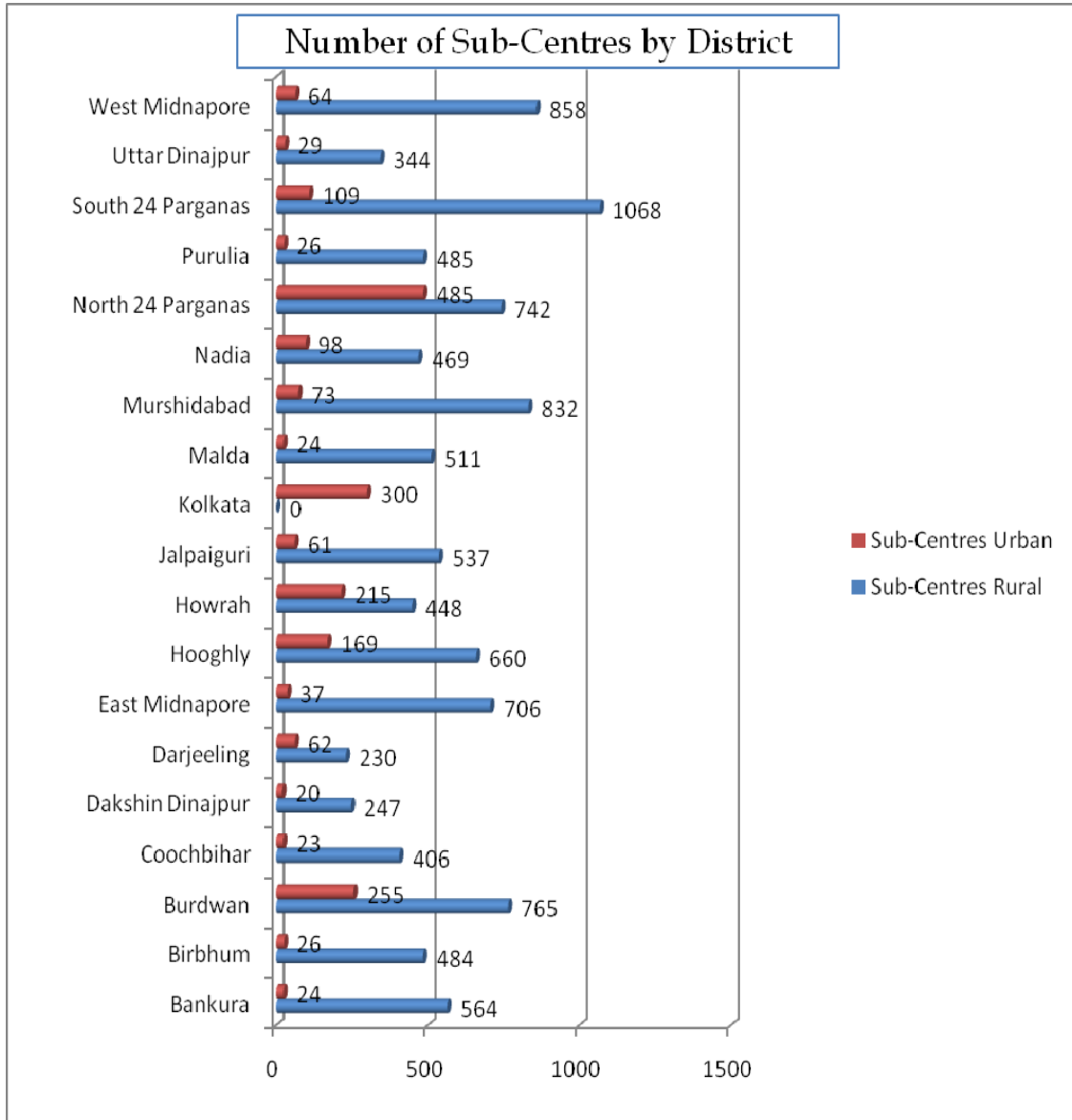

There are 10,356 Rural and 2100 Urban Sub-Centres, i.e., lowest level government non-bedded rural HCUs for immunisation and treatment. The number of rural sub-centres is largest (1068) in South 24 Parganas and smallest (230) in Darjeeling. In Kolkata obviously there is no rural Sub-Centre. The number of urban sub-centres is largest (485) in North 24 Parganas and smallest (20) in Dakhsin Dinajpur. Sub-Centres conduct outreach immunisation sessions in remote areas under their purview at least once in a week.

c. Urban (Municipal) Non-Bedded HCUs (Sub-Centres and Extended Special Out Patient Departments - total number in a district).

In municipal urban agglomerations non-bedded HCUs - Sub-Centres (SCs) and Extended Special Out Patient Departments (ESOPDs) are run by municipalities to attend to citizens' health care needs similar to those of rural sub-centres.

There are a total of 1,740 SCs and 48 ESOPDs run by municipalities in the state of West Bengal.

It is observed that these urban SCs and ESOPDs are by far the largest in number (506 and 18 respectively) in the district of North 24 Parganas and the lowest in number (11 and 0 respectively) in the district of Purulia.

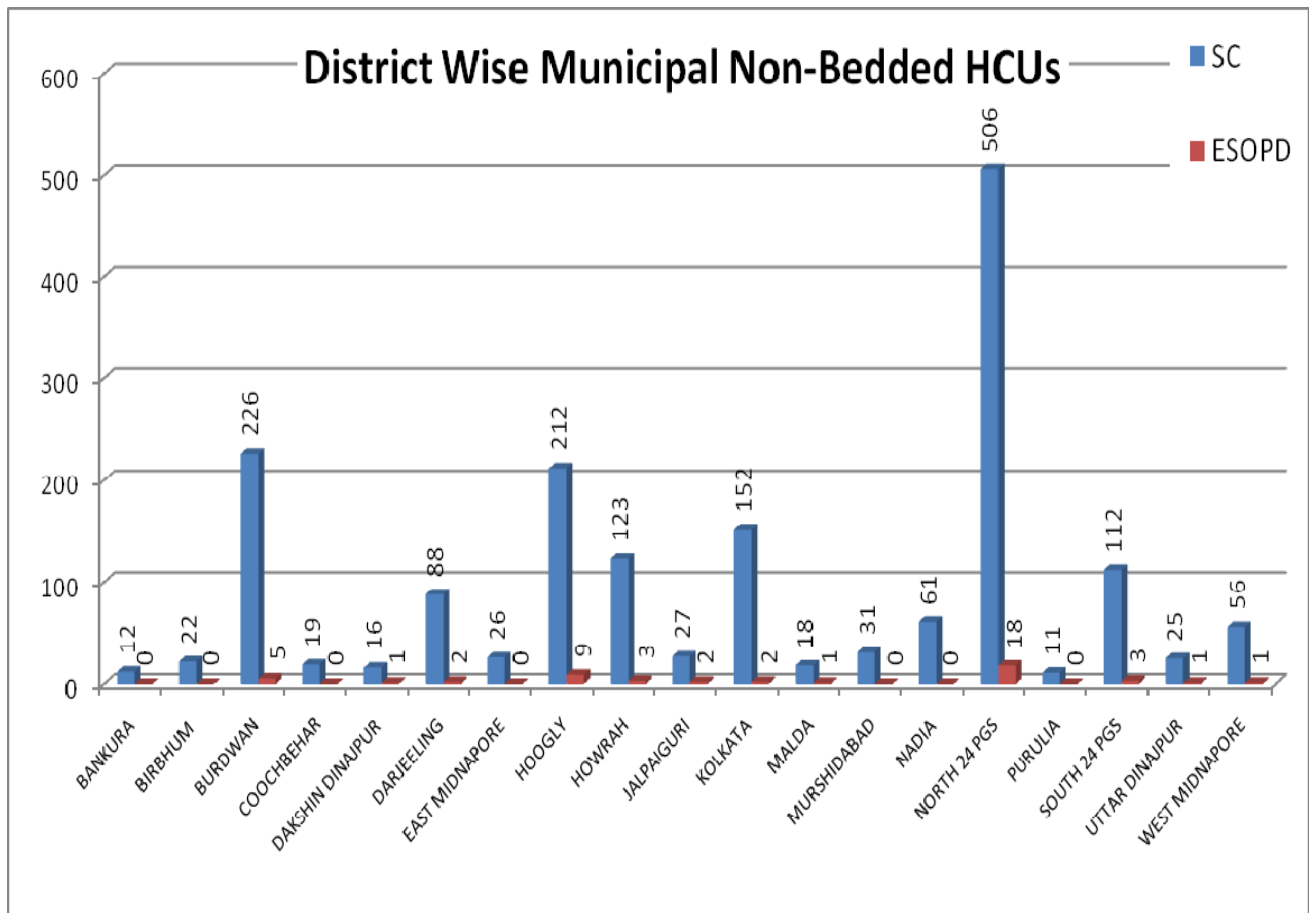

District wise Diagnostic Centre data broadsheet giving all kinds of diagnostic centres available in each district and in the state as a whole.

3,169 Diagnostic Centres of 47 different categories including Blood Bank and spread over 19 districts of the state again call for a broadsheet presentation of data for the sake of a snapshot view of the information.

It is gathered that out of the total number of 3,169 diagnostic centres in the state 2,572 cater to pathological examinations.

BROADSHEET PRESENTATION FOR ALL KINDS OF DIAGNOSTIC CENTRES BY DISTRICT*

DISTRICT	Pathology	Pathology + X-Ray	X-Ray	MRI	Path + ECG + X-Ray	Path + USG + X-Ray	Path + USG	Path + USG + ECG	Path + X-Ray + USG + ECG	Path + Polyclinic	Path + ECG	Path + Clinic	Eye Clinic	Physiotherapy	Polyclinic	Polyclinic + Physiotherapy	C-T Scan	Doctor's Chamber	Diagnostic Centre	Dental	Orthopedic Centre	First-Aid Room	Outdoor	Clinic	USG	ECG	EEG	USG + ECG	ECG + EEG	Blood Bank	Endoscopy	Radiology*	Training Institute	Collection Centre	Collection Centre + X-Ray	USG + X-Ray	ECG + X-Ray	EEG + X-Ray	ERCP	Family Welfare	USG + ECG + X-Ray	Forensic Laboratory	Laser Treatment	Medicine Shop	Med. Manufacturer	Homeopathy Consultancy	Veterinary	Blank	Total			
1	2	3	4	5	6	7	8	9	10	11	12	13	14	15	16	17	18	19	20	21	22	23	24	25	26	27	28	29	30	31	32	33	34	35	36	37	38	39	40	41	42	43	44	45	46	47	48	49	50			
Bankura	71		18				1							2	2		2							1	3		2																								102	
Birbhum	102	1	2																																																	105
Burdwan	138	2	18											2						1			1		4																									1	167	
Coochbehar	46	4	11																					6																											67	
Dakshin Dinajpur	12		4																																																16	
Darjeeling	55	2	2														1											5																							65	
East Midnapore	114	2	4																															1			1													122		
Hooghly	309	20	62										1				1			6	3	2			9	1																							1	416		
Howrah	136	10	16										5	1																																				168		
Jalpaiguri	102	2	6																						2																										113	
Kolkata	420	12	12	1	14	6	2	2	13	3	5	1	1	1	2	1		13	2	10	1		3	1	8	1	1	1	1	1	4	2	1	1	1	9	1	13	3	1	1	4	1	2	1	2	1	1	1	1	1	587
Malda	17		2																																																	19
Murshidabad	113	5	25										1													9																									153	
Nadia	167	19	59										1	4			3				1		2	2	5		1			1																					266	
North 24 Pgs.	296	16	40										3	1						4				1	4							1	1																	2	369	
Purulia	38		21												7		1								14	2																									83	
Uttar Dinajpur	46	2	15																						4																										67	
South 24 Pgs.	90	3	27										2										5																												129	
West Midnapore	145	6	3										1																																						155	
Total	2417	106	347	1	14	6	3	2	13	3	5	1	15	11	11	1	9	13	2	22	4	2	11	5	73	4	4	1	1	5	4	2	3	10	1	14	3	1	1	4	1	2	1	2	1	1	2	4		3169		

* Categories are as given in the list of Diagnostic Centres available with WBPCB.

**QUANTIFICATION OF BMW
GENERATED
IN SELECTED HCU_s**

Objective

A quantification study was conducted in different categories of selected health care units to approximate and arrive at average amount of bio-medical waste generated in the HCUs of respective categories. **This in turn would help in assessing total BMW generated in different categories of Health Care Units in every district as well as in the state as a whole.** Categories of health care units taken up and respective methods of assessment had been as in the following:

Government HCUs

HCUs	Method of Assessment
Large Referral Hospitals [Tertiary]	All BMW generated by category per day by HCU for 4 consecutive days. Five Hospitals. Two in South Bengal, two in Kolkata and one in North Bengal
District, State General, Sub-Divisional & Rural Hospitals [Secondary]	All BMW generated by category per day by HCU for 4 consecutive days. Two hospitals in each category. Eight hospitals in all. One each of every category of HCU in South Bengal and North Bengal.
Block Primary Health Centres (BPHCs) & Primary Health Centres (PHCs)	All BMW generated by category per day by HCU for 4 consecutive days. Four Hospitals. Two HCUs (BPHC+PHC) each in South Bengal and North Bengal
Lowest level Immunisation & Health Care Units [Sub-Centres]	All BMW generated by category per day by HCU for 2 consecutive clinic days. Two SCs. One each in South Bengal and North Bengal. Records of Out Reach Sessions (ORS) were also collected from concerned sub-centres which conduct the ORSs.

Municipal HCUs

HCUs	Method of Assessment
Hospital	All BMW generated by category per day by HCU for 4 consecutive days. Two Hospitals. One each in South Bengal and North Bengal.
Maternity Unit	All BMW generated by category per day by HCU for 4 consecutive days. Two Hospitals. One each in South Bengal and North Bengal.
Extended Specialised Out Patient Department (ESOPD)	All BMW generated by category per day by HCU for 2 consecutive clinic days. Two ESOPDs. One each in South Bengal and North Bengal.
Sub Centres	All BMW generated by category per day by HCU for 2 consecutive clinic days. Two Units. One each in South Bengal and North Bengal

Private HCUs including Diagnostic Centres (DCs)

HCUs	Method of Assessment
Hospital Private Hospitals [Very Large: 300+ beds; Large: 100+ to 300 beds; Medium: 50 + to 100 beds; Small: Upto 50 beds]	All BMW generated by category per day by HCU for 4 consecutive days. Four Hospitals. One each of very large, large, medium & small categories.
Diagnostic Centres in KMC Area [Large: Medium: Small]	All BMW generated by category per day by HCU for 4 consecutive days. Three Diagnostic Centres. One each of large, medium & small categories.

Specialty Hospitals

HCUs	Method of Assessment
1 Dental Hospital	All BMW generated by category per day by HCU for 4 consecutive days in one of each category of HCUs.
1 Infectious Disease Hospital	
1 Cancer Hospital	
1 TB Hospital	
1 Eye Hospital	
1 Leprosy Hospital	
1 Veterinary Hospital	

Assessment of generation of BMW in the **Forensic Science Laboratory**, Govt. of West Bengal and **Institute of Animal Health and Veterinary Biologicals (IAHVB)** in Kolkata was also conducted.

Names of HCUs selected for assessment**Government Health Care Units**

Category of HCUs	Location	HCUs Surveyed
Large Referral Hospitals [Tertiary]	2 in South Bengal	1. Burdwan MCH, Burdwan 2. Bankura Sammilani MCH, Bankura,
	2 in Kolkata	1. Calcutta National MCH, 24 Gorachand Road, Kolkata 700014 2. R. G. Kar MCH, 1 Belgachia Road, Kolkata 700037
	1 in North Bengal	1. North Bengal MCH, Shushrutanagar, Darjeeling
District, State General, Sub-Divisional & Rural Hospitals [Secondary Level]	2 District Hospitals. One each in South Bengal and North Bengal	1. Barasat DH, Barasat, North 24 Parganas 2. Siliguri DH, Siliguri, Darjeeling
	2 Sub-Divisional Hospitals. One each in South Bengal and North Bengal	1. Bishnupur SDH, Bishnupur, Bankura 2. Malbazar SDH, Malbazar, Jalpaiguri
	2 State General Hospitals. One each in South Bengal and North Bengal	1. Vidyasagar SGH, Brahma Samaj Road (D.H.Road) Kolkata 700034 2. Birpara SGH, Birpara, Jalpaiguri
	2 Rural Hospitals. One each in South Bengal and North Bengal	1. Taldangra RH, Taldangra, Bankura 2. Kharibari RH, Kharibari, Darjeeling
Block Primary Health Centres (BPHCs) & Primary Health Centres (PHCs)	2 Block Primary Health Centres. One each in South Bengal and North Bengal	1. Anchuri BPHC, Anchuri, Bankura 2. Matigara BPHC, PO - Matigara, Darjeeling
	2 Primary Health Centres. One each in South Bengal and North Bengal	1. Panchmura PHC, Taldangra, PO - Panchmura, Bankura 2. Bagdogra PHC, Bagdogra, Darjeeling
Lowest level HCU [Sub-Centres] and attached Out-Reach Sessions	Two SCs. One each in South Bengal and North Bengal	1. Anchuri SC, Anchuri, Bankura (with ORS) 2. Kharibari SC, Kharibari, Darjeeling (with ORS)

Municipal HCUs

Category of HCUs	Location, Size, Type	HCUs Surveyed
Hospital	Two Hospitals. One each in South Bengal and North Bengal	1. Dum Dum Municipality Specialized Hospital, Dum Dum, 24 Pgs (N) 2. Vivekanandapally Matrisadan and Municipal Hospital, Malda
Maternity Unit	Two Units. One each in South Bengal and North Bengal	1. Maternity Home, B. T. Road, Titagarh, 2. Matri Sadan, Balurghat Municipality, South Dinajpur
ESOPDs	Two ESOPDs. One each in South Bengal and North Bengal	1. Dum Dum Municipality 2. English Bazar Municipality
Sub-Centres	Two Centres. One each in South Bengal and North Bengal	1. Titagarh Municipality 2. Balurghat Municipality

Private HCUs and DCs

Category of HCUs	Size, Type	HCUs Surveyed
Private Hospitals [Very Large: 300+ beds; Large: 100+ - 300 beds; Medium: 50+ - 100 beds; Small: Upto 50 beds]	Four Hospitals. One each of very large, large, medium & small categories.	1. Advanced Medical Research Institute (AMRI), P-4 & 5, C.I.T. Sch, Block-A, 15, Panchanantala Road, Kol -700029 2. Woodlands Hospital, 8/5 Alipore Road, Kol - 700027 3. Institute of Child Health, 11, Dr, Biresh Guha Street, Kol - 700017 4. Manik Chandra Nandy N. Home, Pratapbagan , Bankura
Diagnostic Centres [Large: 5000+ patients/month; Medium: 1000 - 5000 patients/month; Small: Below 1000 patients/month]	Three Diagnostic Centres. One each of large, medium & small categories.	1. Drs. Tribedi and Roy Diagnostic Laboratory, 93 , Park street : Kol 16 2. Narendra Seva Trust, 26, Gariahat Road Kolkata - 31 3. Ramkrishna Pathological Lab, Hospital Road, Mathabhanga, Cooch Behar

Specialty HCUs

Category of HCUs	Size, Type	HCUs Surveyed
7 Categories of Specialty Hospitals	Dental Hospital	Dr. R. Ahmed Dental College, 114 A. J. C. Bose Road, Kolkata 700014
	Infectious Diseases Hospital	BG & I.D. Hospital, Belegkata Main Road, Kolkata 700010
	T B Hospital	K. S. Roy T.B. Hospital, K. S. Roy TB Hospital, Kolkata -700032
	Cancer Hospital	Chittaranjan National Cancer Institute, 37 S. P. Mukherjee Road Kolkata 700026
	Leprosy Hospital	Premananda Memorial Leprosy Hospital, 259 A, A. P. C. Road, Kolkata 700006
	Veterinary Hospital	Institute of Animal Health and Veterinary Biologicals, 37 Belgachhia Road, Kolkata -700037
	Eye Hospital	DISHA Eye Hospital & Research Centre , Barrackpore, Kolkata 700120

Methodology of Quantification:

The study has been conducted through survey, with following steps:

- Identification of the items of bio-medical waste generated in the HCUs and coming into the waste stream,
- Classification of the items by category according to BMW Rules,
- Classification of the items further as recyclable and non-recyclable. Cat 4 (needles, broken glass etc) and Cat 7 (plastic, glass and metal) have been marked as recyclables. Again Categories 1, 2, 3, 5, 6 (Body parts and the soiled materials) have been marked as non-recyclable though some materials like cloth may be recycled),
- Ascertaining bio-medial waste generation per bed per day or per person per day in respective categories of HCUs.

The administrative authorities of the HCUs and the staff were given prior information and necessary instructions before the actual quantification. Particularly hospital sweepers, scavenger service workers, ward sisters and other health workers in each HCU were notified prior to the commencement of the quantification study.

Waste Assessors from DISHA took charge of the waste sent at the vat sites or disposal sites of the HCUs from each waste generation point of the HCUs. Contents of each of the bags were taken out, thoroughly checked and sorted irrespective of the colour of bags to ensure more accurate categorization of waste in anticipation of possible mixing.

Items of each category were manually separated and measured by weighing balance.

None of the HCUs had any facility to separately store or treat liquid waste. So liquid waste was not included in quantification study. Animal body waste was available only in Institute of Animal Health and Veterinary Biologicals (IAHVB). So Category 2 has been excluded from the quantification table of all HCUs except IAHVB. Incineration ash was available only in the Common Bio-medical Waste Treatment Facilities. Amounts of incineration ash generated in these facilities were recorded and submitted to WBPCB in their annual reports; as such no separate quantification was necessary. Liquid portion of Chemical waste (Cat 10) was generally drained out and solid portion also was not separately collected. As such quantification of the same could not be possible. So Categories 8, 9 and 10 have been excluded from the quantification study.



In every bedded HCU under study data on occupancy were collected for each day during the four days' quantification survey (except sub-centres where data for 2 days were collected as those did not function everyday). The total quantity of BMW generated has been divided by occupancy to arrive at **BMW generation per bed per day** in case of bedded HCUs. In case of sub-centres, out reach sessions, municipal ESOPD and sub-centres, attendance of patients / persons at the HCUs was collected and recorded. For these non-bedded HCUs total quantity of BMW generated has been divided by attendance to arrive at **BMW generation per patient/person per day**. In case of pathological laboratories number of specimens tested was collected and recorded. The total quantity of BMW generated has been divided by number of specimens to arrive at **BMW generation per specimen per day**.

Constraints

The survey had to depend on the existing waste management system of the health care units and pathological laboratories. As such, in spite of best possible efforts under the circumstances, variation in the quality of the system operating in different hospitals affected the study in the following ways:

- i) Collection and hauling of all the waste to the quantification point could not be fully ensured in spite of best possible efforts because of prevailing practice of salvaging, irregular collection and disposal in some units.
- ii) Improper segregation and collection of waste made quantification of BMW very difficult and prone to inaccuracy in many instances.

Quantification Data

The data on quantification of each health care unit and pathological laboratory under study have been appended in the annexure. However salient features of the study are discussed in the following:

Government HCUs

Among the government hospitals it was found that generation of bio-medical waste per bed per day varied in accordance with availability of number of different treatments and laboratory tests. Thus the Medical Colleges and Hospitals produce highest amount of waste per bed per day. District Hospitals produce next to that.



State General Hospitals and Sub-Divisional Hospitals having almost similar kinds of facilities produce almost same amount of bio-medical waste per bed per day and that is less than that of District Hospitals. Rural Hospitals, Block Primary Health Centres and Primary Health Centres produce bio-medical waste in diminishing amounts.

In case of Sub-Centres and Out Reach Sessions the pattern of BMW produced is entirely different. These are non-bedded HCUs with mainly clinical and immunization facilities. So production of waste is much less but major portion of the waste is recyclable. Average bio-medical waste has been calculated per patient per day. Sub-Centres generally produce BMW twice a week and Out Reach Sessions once in a week.

A comparative study showing bio-medical waste generated per Bed per Day and per Patient per Day in government health care units (HCUs):

HCU Categories	Unit	Wt. in gms
Medical College & Hospital	Per Bed per Day	281
District Hospital	Per Bed per Day	263
Sub-Divisional Hospital	Per Bed per Day	245
State General Hospital	Per Bed per Day	246
Rural Hospital	Per Bed per Day	227
Block Primary Health Centre	Per Bed per Day	216
Primary Health Centre	Per Bed per Day	207
Sub-Centre & Out Reach Session	Per Patient per Day	31

In bedded hospitals it is found that two major constituents of bio-medical waste (BMW) are Cat 6 and Cat 7. Again the weight of non-recyclable BMW (Cat 1, 3, 5 and 6) is almost double that of recyclable BMW (Cat 4 and 7). Average weight of used saline bottles ranges from 20% to 30% of Category 7.

In case of Sub-Centres and Out-reach Sessions character of composition is different. Here proportion of non-recyclable BMW (Cat 6) like cotton swabs is produced in negligible amount. Major portion of the BMW is composed of recyclable BMW (Cat 7) like needle, syringes, glass and plastic vials etc.

Average generation of BMW with proportionate weight and percentage of different categories in each level of HCUs may be seen in the following charts. Detailed figures may be seen in annexures. For convenience decimal fractions have been avoided in the charts.

Medical College and Hospitals

Average bio-medical waste generation in 5 Medical Colleges and Hospitals namely Burdwan, Bankura Sammilani, Calcutta National, R. G. Kar and North Bengal MCHs:

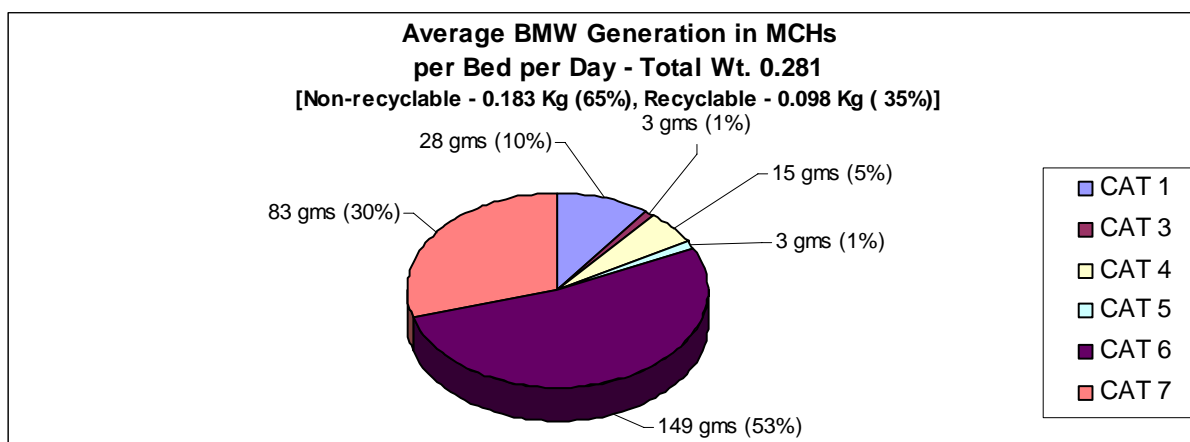

District Hospitals

Average bio-medical waste generation in 2 District Hospitals namely Barasat, North 24 Parganas District and Siliguri, Darjeeling District :

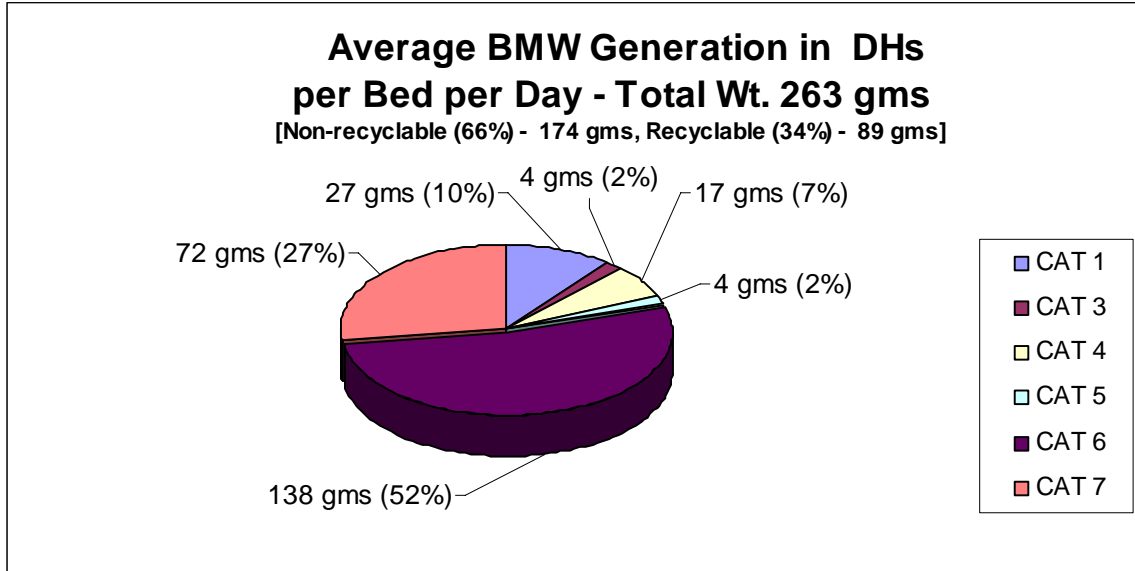

Sub-Divisional Hospitals

Average bio-medical waste generation in 2 Sub-Divisional Hospitals namely Bishnupur, Bankura District and Malbazar, Jalpaiguri District:

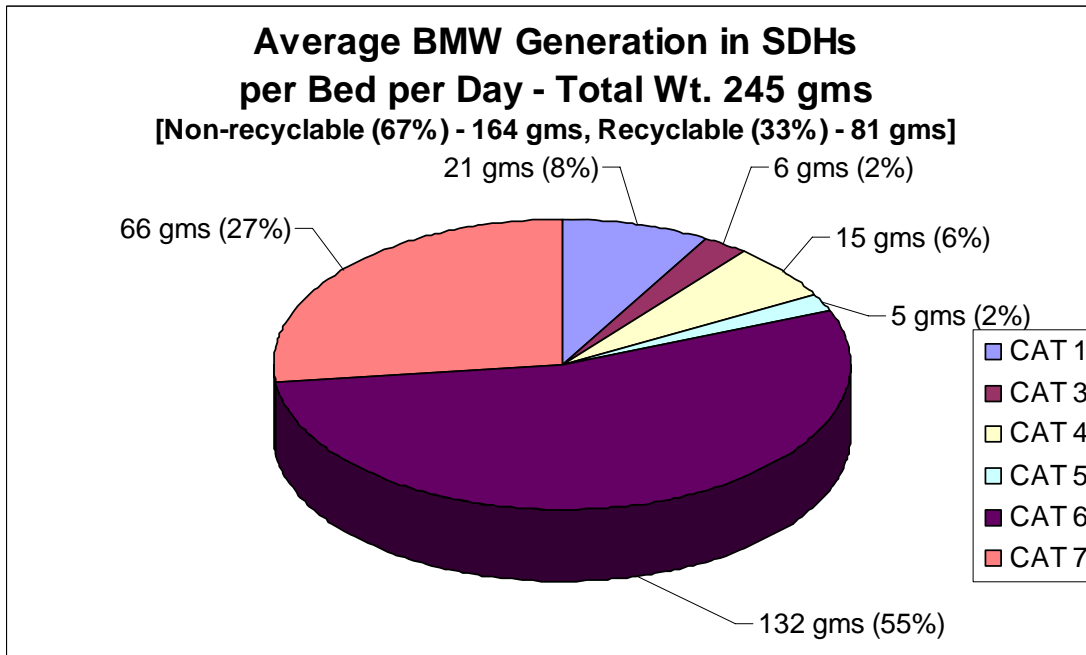

State General Hospitals

Average bio-medical waste generation in 2 State General Hospitals namely Vidyasagar, Kolkata District and Birpara, Jalpaiguri District:

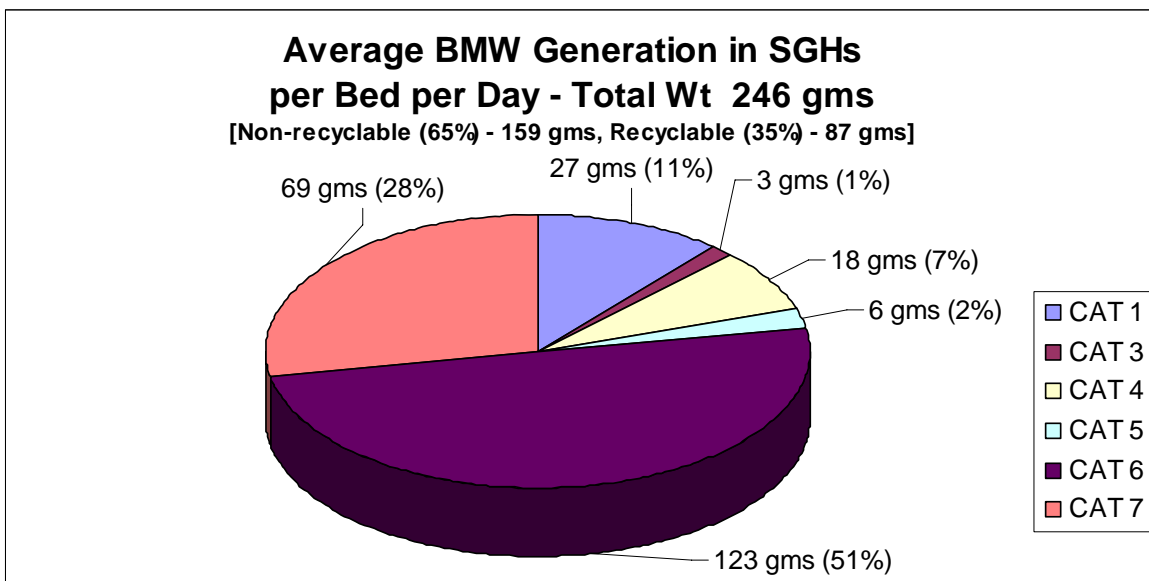

Rural Hospitals

Average bio-medical waste generation in 2 Rural Hospitals namely Taldangra, Bankura District and Kharibari, Darjeeling District:

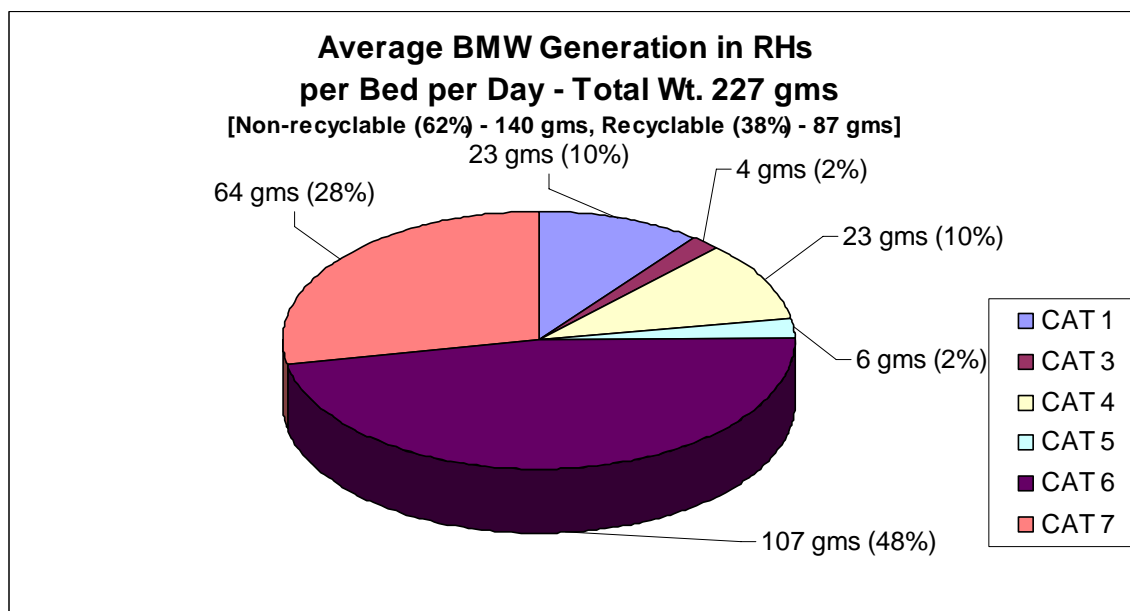

Block Primary Health Centres

Average bio-medical waste generation in 2 Block Primary Health Centres namely Anchuri, Bankura District and Matigara, Darjeeling District:

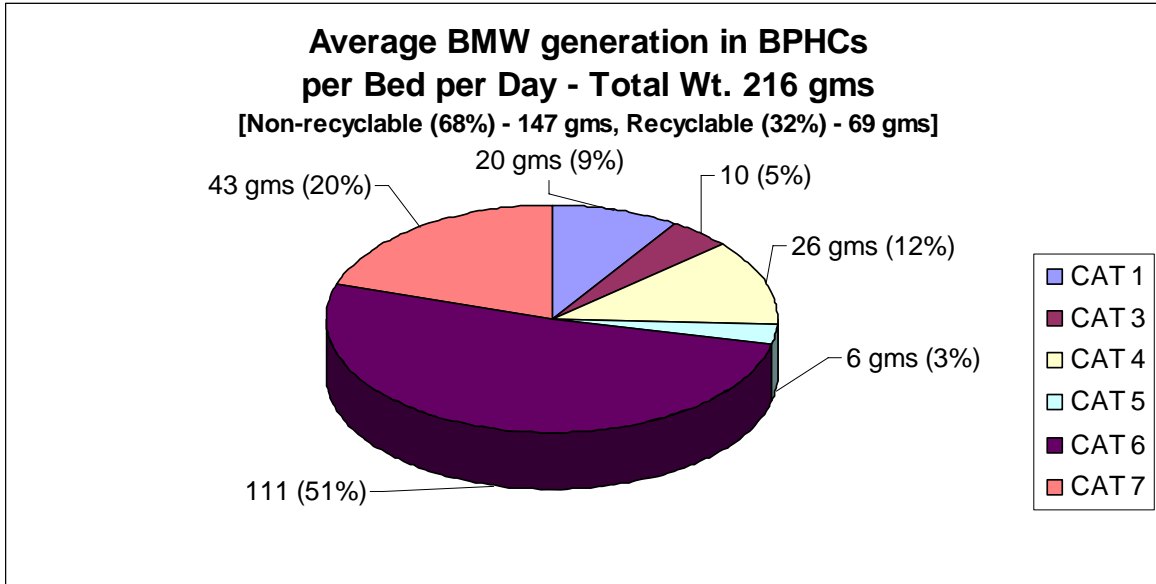

Primary Health Centres

Average bio-medical waste generation in 2 Primary Health Centres namely Panchmura, Bankura District and Bagdogra, Darjeeling District :

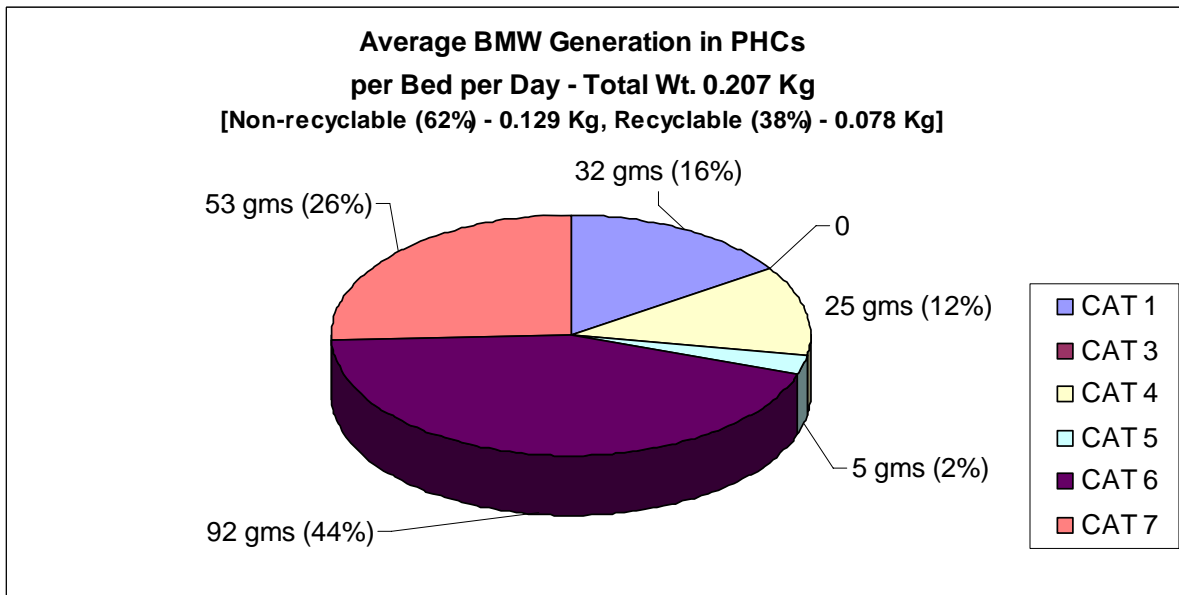

These facilities do not have any laboratory. So Cat 3 is not produced.

Sub Centres and Out-Reach Sessions

Average bio-medical waste generation in 2 Sub-Centres namely Anchuri, Bankura District and Kharibari, Darjeeling District with their Out-Reach Sessions:

These facilities do not generate any anatomical waste (Cat 1), laboratory waste (Cat 3) and discarded medicines (Cat 5). As mentioned earlier, here proportion of non-recyclable waste (Cat 6) is almost negligible with respect to recyclable waste like syringes, needles and glass and plastic vials etc. (Cat 4 and 7).

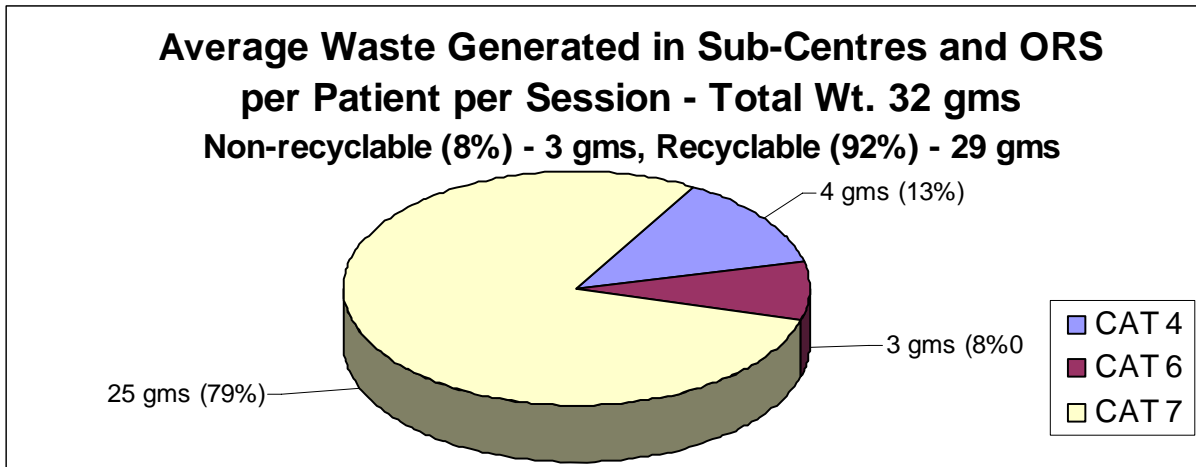

Municipal Health Care Units

These are smaller units having bed strength below 50 and moderate service facilities. The hospitals situated in municipal areas produce bio-medical waste per Bed per Day at an average of **253 gms** and almost equal to that of government SDHs and SGHs. But in case of municipal maternity homes the generation is found higher (**288 gms**) due to larger generation of placenta (Cat 1) and soiled waste (Cat 6).

Municipality Hospitals

Average bio-medical waste generation in 2 Municipality Hospitals namely Dum Dum Specialty Hospital, Dum Dum Municipality and Vivekananda Palli Matrisadan and Hospital, Malda:

Laboratory waste (Cat 3) was available only in Dum Dum Municipality Hospital.

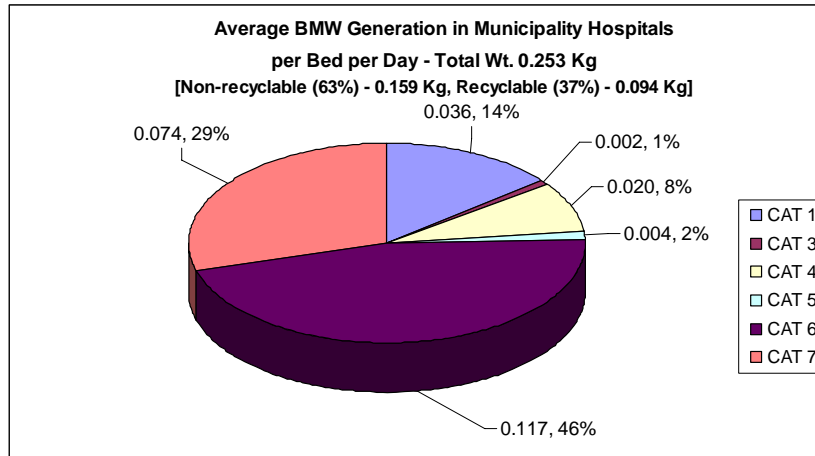

Municipal Maternity Homes

Average bio-medical waste generation in 2 Municipal Maternity Homes namely Balurghat Municipality and Matrisdan and Matrisadan, Titagarh Municipality :

Laboratory waste (Cat 3) was not available in these HCUs.

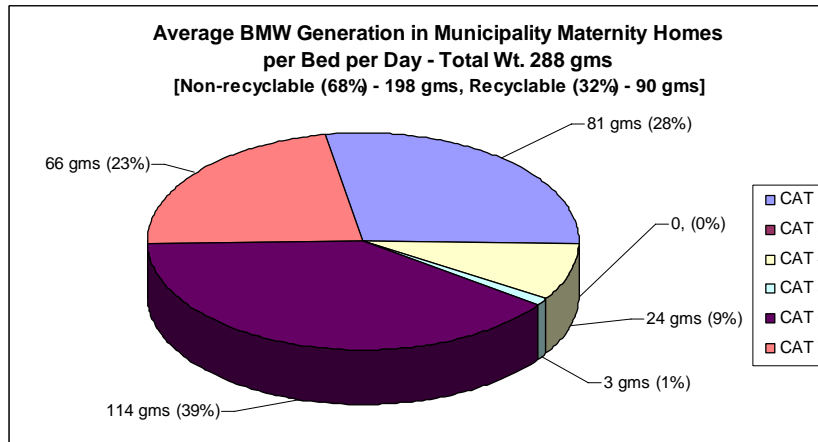

Municipal Extended Specialised Out-Patient Department (ESOPD) and Sub-Centres(SC)

Like Sub-Centres in government HCUs, the municipal ESOPD and Sub-Centres do not generate any anatomical waste (Cat 1), Laboratory Waste (Cat 3) and discarded medicines (Cat 5). Non-recyclable waste (Cat 6) is also very negligible. Major portion of the waste is composed of syringes, needles, glass vials etc. Average waste generation in municipal clinics per Person per Session is 24 gms whereas in municipal immunization centres 27 gms.

Average bio-medical waste generation in 2 Municipal ESOPD namely Dum Dum Municipality Hospital ESOPD and Balurghat ESOPD :

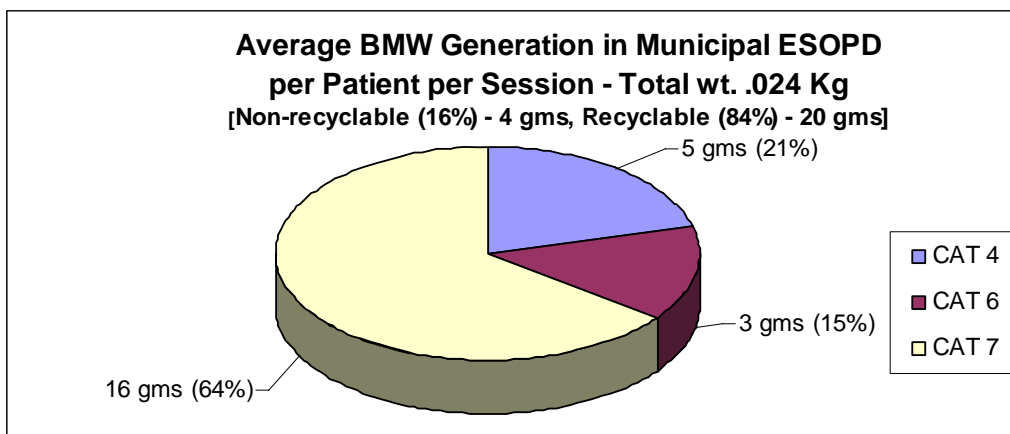

Municipal Immunization Centres

Average bio-medical waste generation in 2 Municipal Immunization Centres namely Titagarh Municipality and Balurghat Municipality:

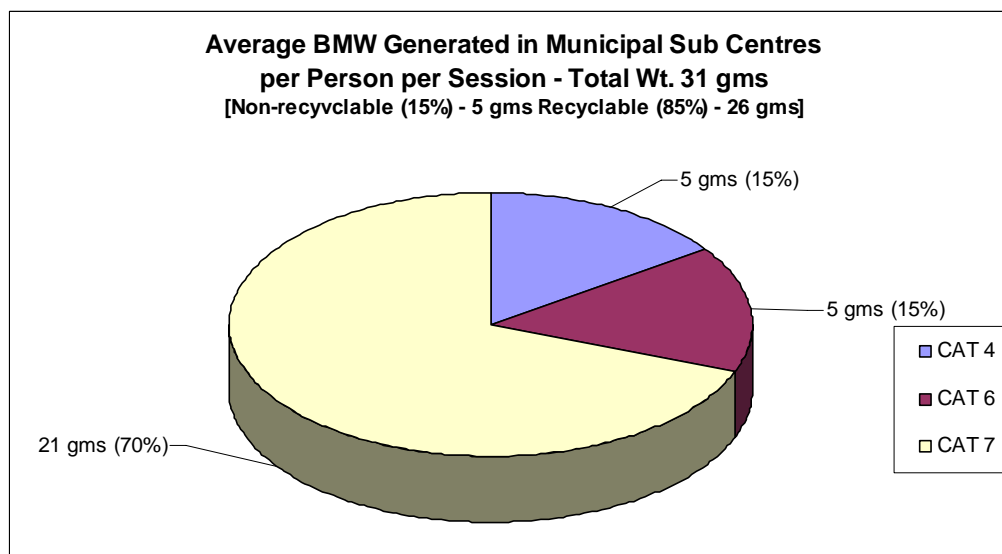

Private Hospitals

4 private hospitals of different categories by size viz., Very Large, Large, Medium and Small were taken up for study. It is observed that compared to government hospitals of similar bed strength, private hospitals generate considerably more bio-medical waste.

HCU Categories	Unit	Wt. of BMW generated (gms)
Very large Pvt. Hospital (300+ bed strength)	Per Bed per Day	542
Large Pvt. Hospital (100 to 300 bed strength)	Per Bed per Day	523
Medium Hospital (50 to 100 Bed Strength)	Per Bed per Day	371
Small Hospital (below 50 bed strength)	Per Bed per Day	312

Another feature of BMW generated in private hospitals is that the proportion of recyclable waste was found to be more compared to that of government and municipal hospitals. Generation of recyclable waste in private HCUs almost equals that of non-recyclable waste. Average bio-medical waste generation in the HCUs under study:

Very Large - AMRI, Kolkata

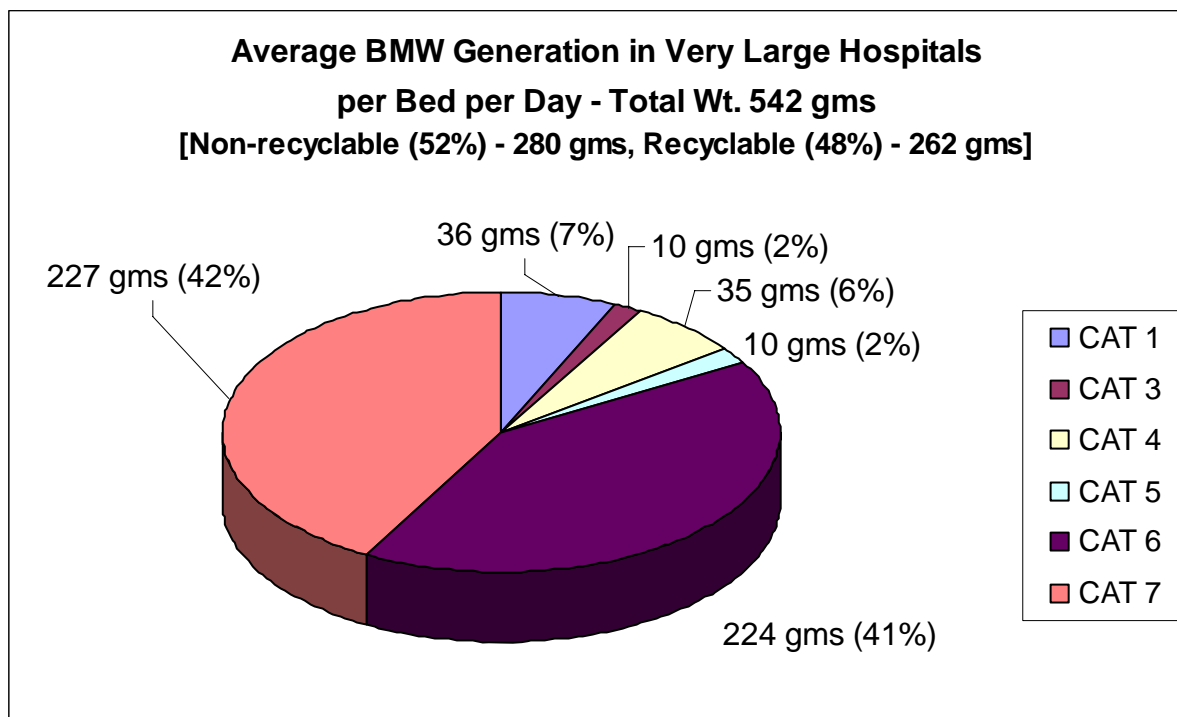

Large - Woodlands, Kolkata

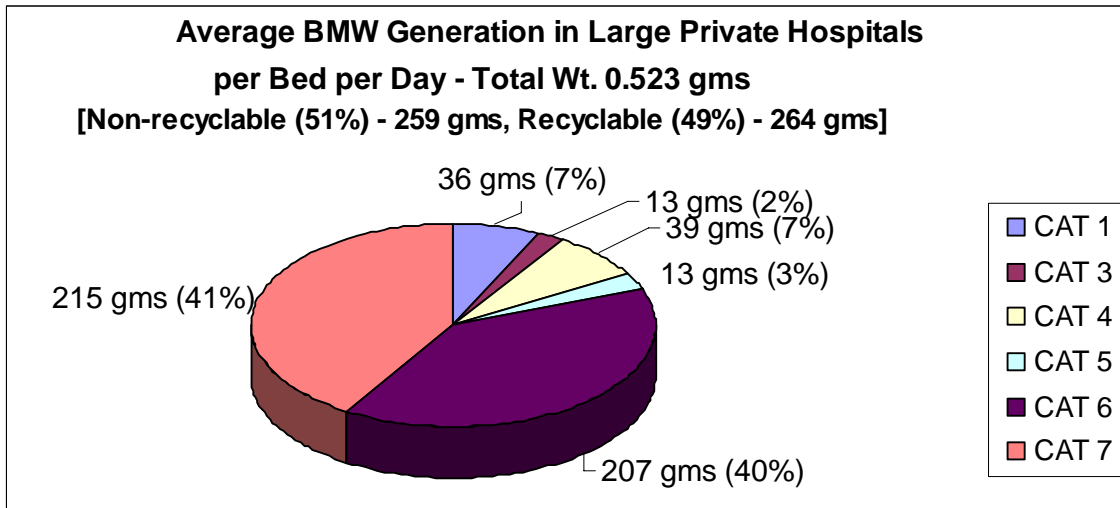

Medium - Institute of Child Health, Kolkata

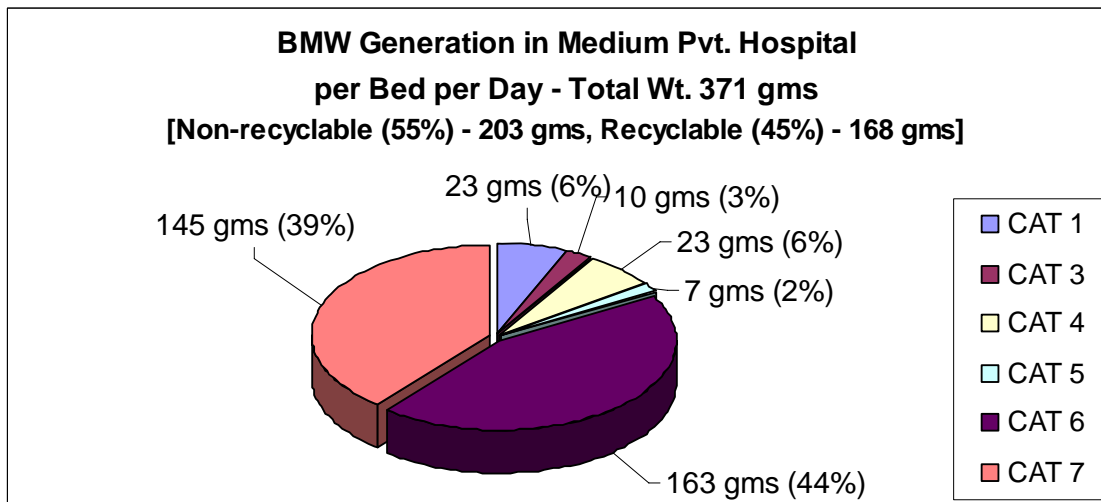

Small - Dr. M. N. C. Nursing Home, Bankura

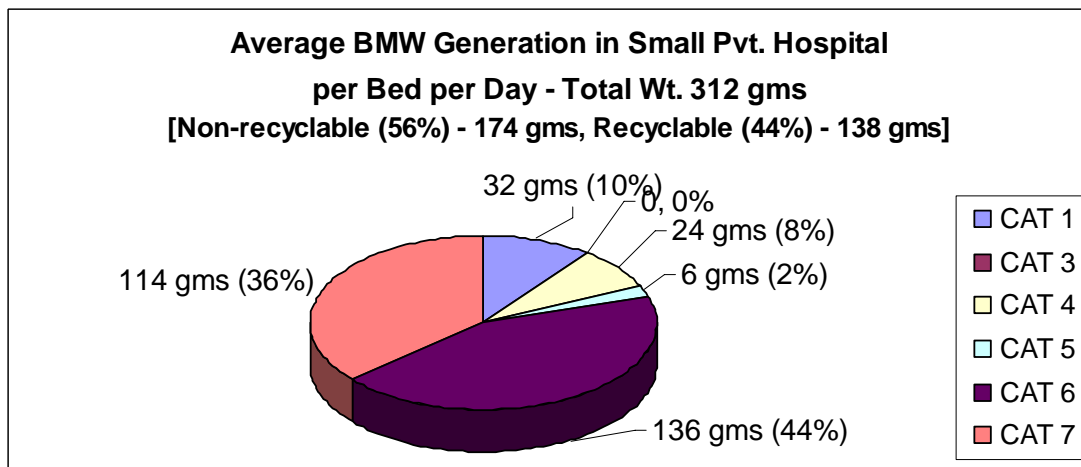

Specialty Hospitals

Quantification studies were conducted in 7 other specialty hospitals having special kind of treatment facilities. These were selected to ascertain the pattern and quantity of generation of bio-medical waste in similar group of hospitals. Average bio-medical waste generation in the HCUs under study:

Chittaranjan National Cancer Research Institute

It was found that, due to absence of delivery cases, the proportion of anatomical waste (Cat 1) was much less with respect to that of general bedded hospitals. A minute amount is generated in surgeries. Proportions of other categories of waste are more or less similar to those of general government bedded hospitals. Generation per Bed per Day was **247 gms.**

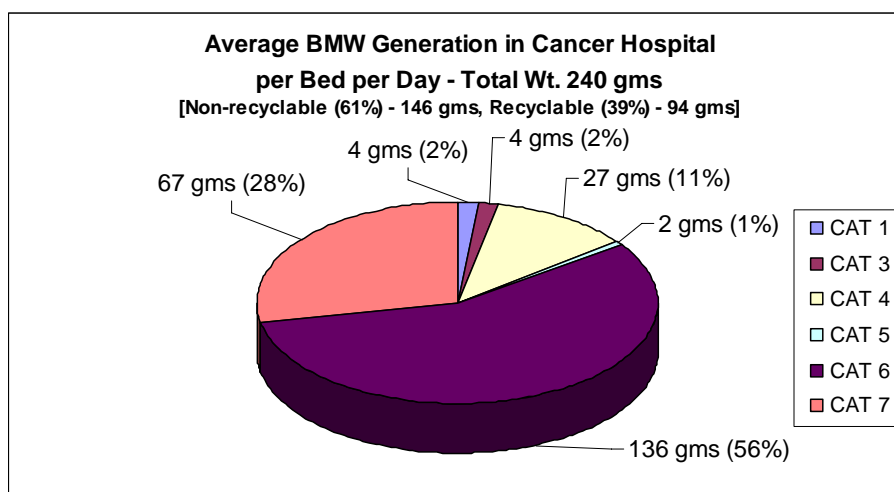

ID & BG Hospital

No anatomical waste (Cat 1) was produced here as there is no deliver case and surgery. Waste generated per Bed per Day found to be **236 gms.**

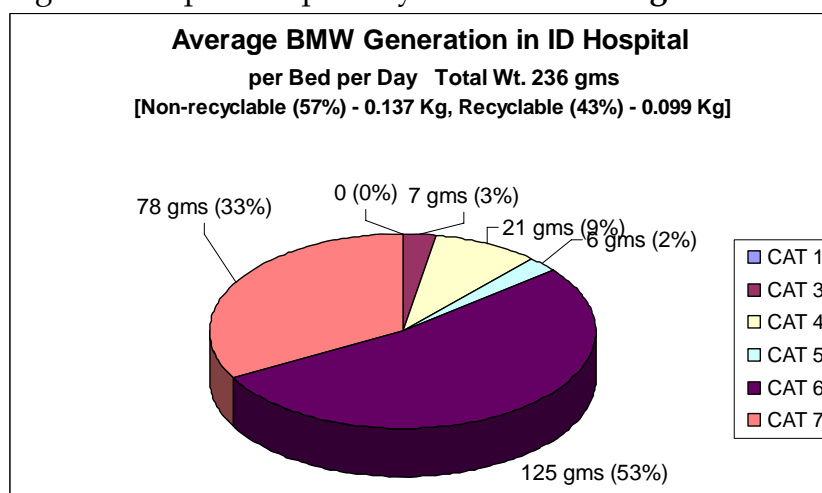

K. S. Roy TB Hospital

Here also no anatomical waste was generated. Amounts of other bio-medical wastes were found to be less in comparison with that of general bedded government hospitals. A major part of treatment is based on oral drugs and injections.

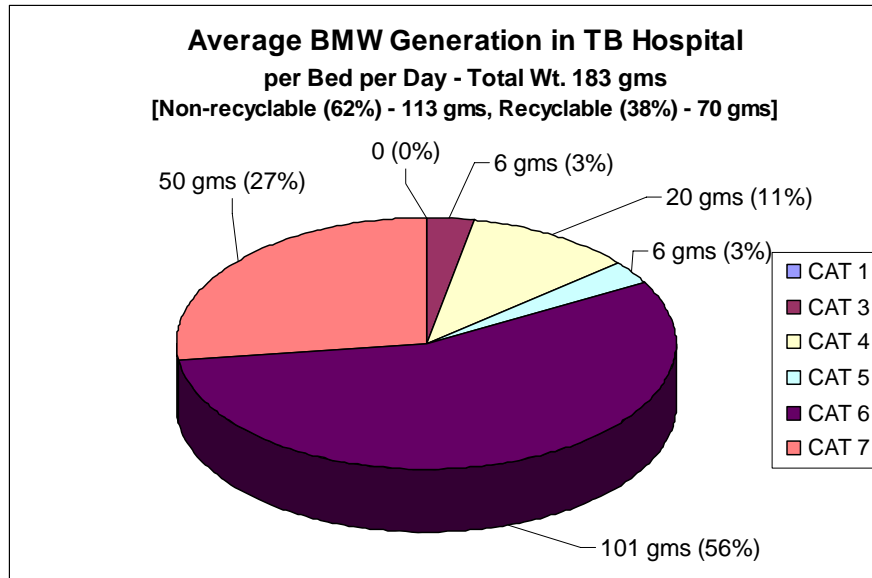

Premananda Memorial Leprosy Hospital

Leprosy hospitals generated BMW almost like general hospitals. But in absence of delivery cases the proportion of anatomical waste (Cat 1) is less. Also proportion of cotton and bandage (Cat 6) is at higher range.

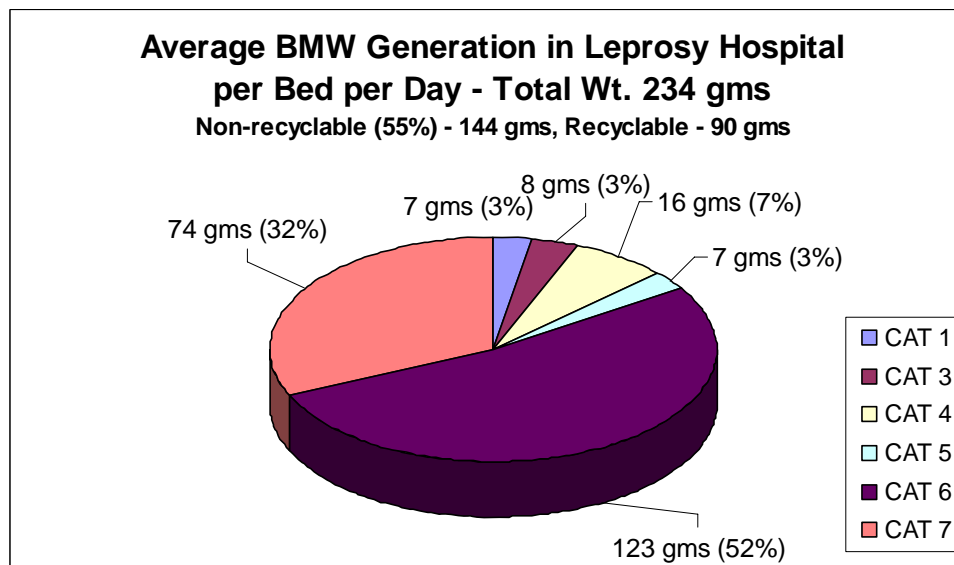

DISHA Eye Hospital and Research Centre

These are bedded facilities. But generally there is no arrangement of night-stay. The beds are used to provide support service and to keep the patient under medical observation for a few hours after operations (mainly cataract). So the waste has been quantified per operated patient per day. Anatomical waste was not found in the waste. Average waste generation in such hospitals is much less than the general bedded HCUs.

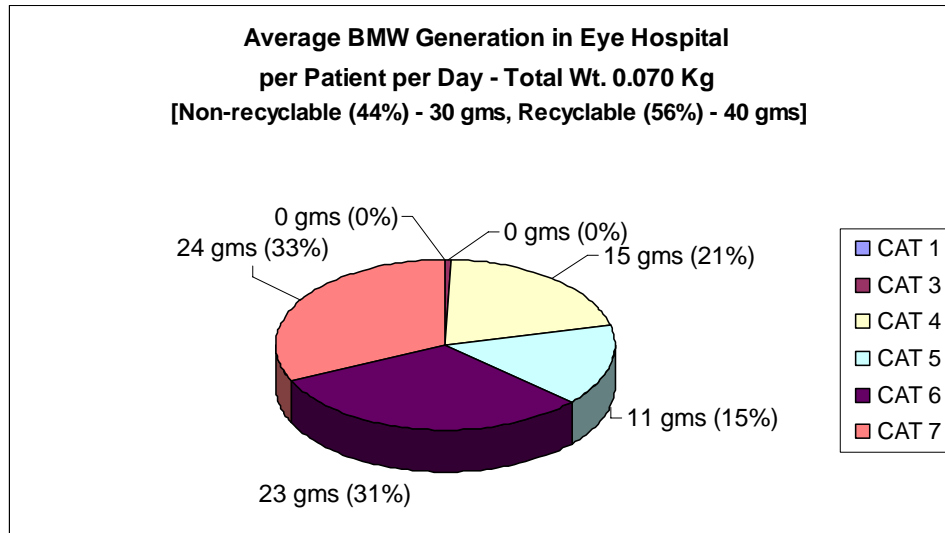

Dr. R. Ahmed Dental College and Hospital

There is no bedded facility. Anatomical waste is composed of extracted teeth. Total amount of waste is much less than general bedded HCUs.

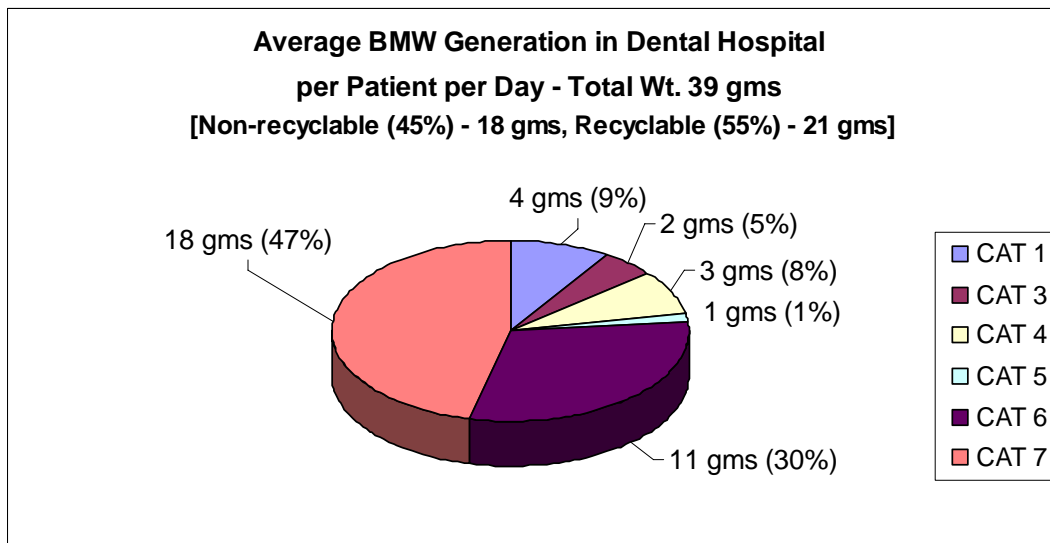

Institute of Animal Health and Veterinary Biologicals

Animal waste (Cat 2) is generated only in such hospital. Animals are taken back by the owners after treatment. Generally the owners are instructed to take back saline bottles and support materials with the animals. Left out materials were found **101 gms** per animal patients per day.

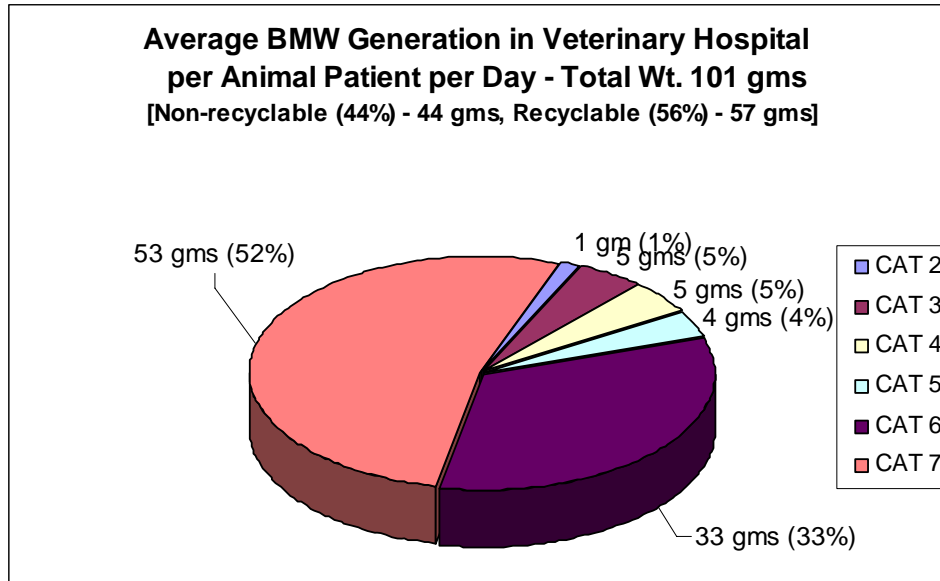

Pathological Laboratories

Some of the pathological laboratories (mainly large ones) have histopathology unit. A good amount of human body parts and tissue waste (Cat 1) is generated in these units. Other pathological laboratories, which do not have histopathology, do not produce Cat 1. Thus total production of Cat 1 from pathological laboratories is very small.

Large - Drs. Trivedi & Roy Diagnostic Laboratory

Average waste generation was found 37 gms per Sample per Day

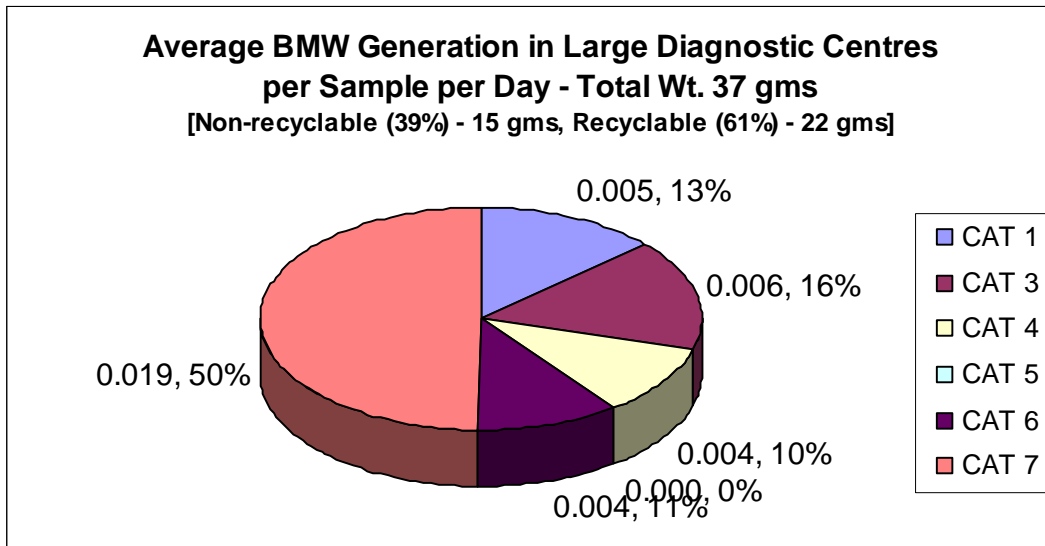

Medium - Narendra Seva Trust

Average waste generation was found 30 gms per Sample per Day

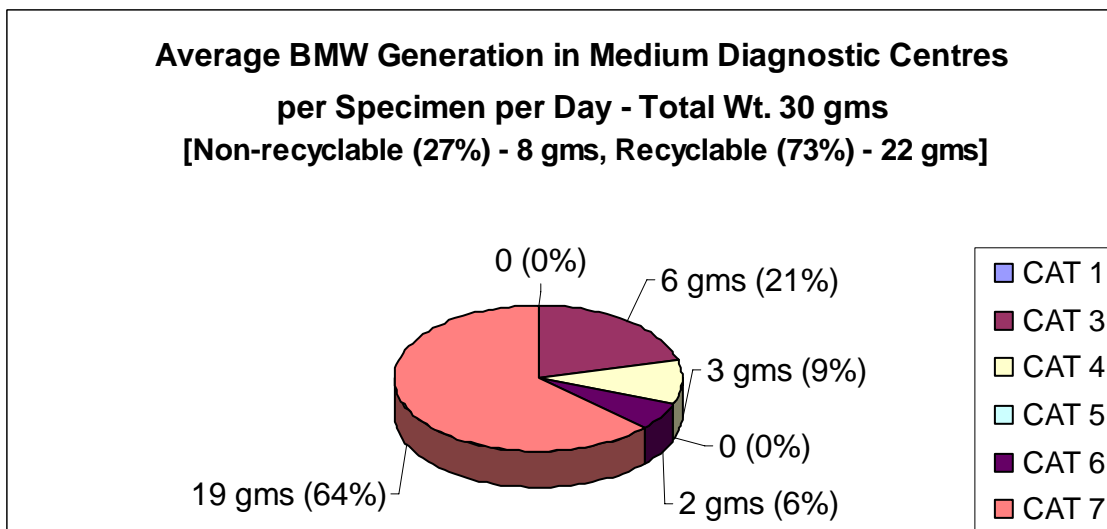

Small - Ramkrishna Pathological Laboratory

Average waste generation was found 30 gms per Sample per Day

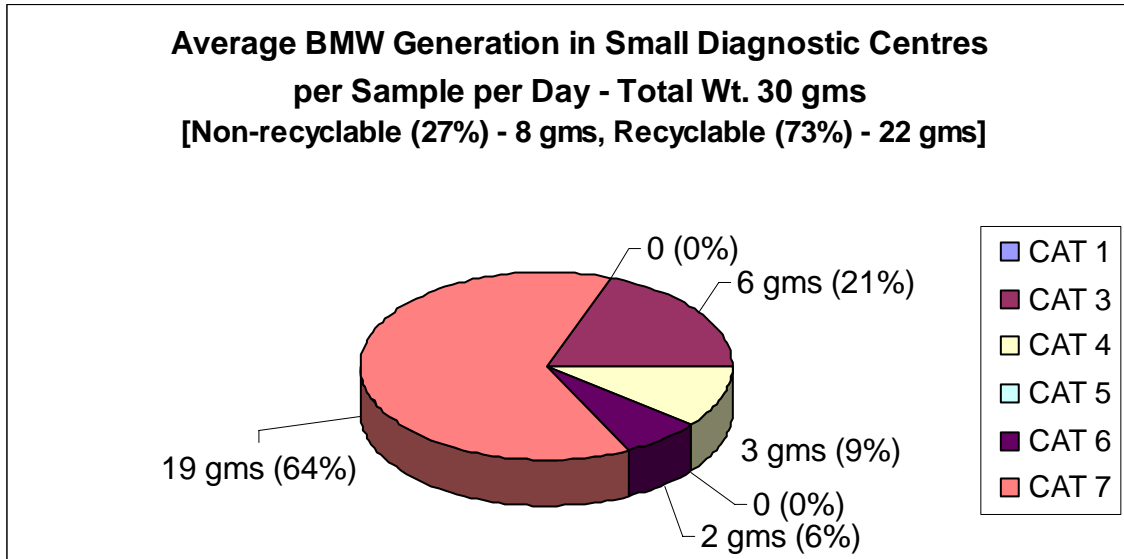

QUANTIFICATION SUMMARY

**BIO-MEDICAL WASTE GENERATED IN DIFFERENT
CATEGORIES OF HCU_s IN WEST BENGAL**

Quantification Summary :

Bio-medical Waste Generated in Different Categories of Health Care Units in West Bengal

The following tables will give an overview of average BMW generation in different categories :

Average BMW Generation							
Wt. in Kg							
A. Bedded Facilities per Bed per Day							
	CAT 1	CAT 3	CAT 4	CAT 5	CAT 6	CAT 7	Total
Government							
MCH	0.028	0.003	0.015	0.003	0.148	0.083	0.281
DH	0.027	0.004	0.017	0.004	0.138	0.072	0.263
SDH	0.021	0.006	0.015	0.005	0.132	0.066	0.245
SGH	0.027	0.003	0.018	0.006	0.123	0.069	0.246
RH	0.023	0.004	0.023	0.006	0.107	0.064	0.227
BPHC	0.020	0.010	0.026	0.006	0.112	0.043	0.216
PHC	0.033	0.000	0.026	0.006	0.091	0.052	0.207
Other Government							
< 50 Beds (BPHC)	0.020	0.010	0.026	0.006	0.112	0.043	0.216
50 - 100 Beds (RH)	0.023	0.004	0.023	0.006	0.107	0.064	0.227
> 101 - 300 Beds (SGH)	0.027	0.003	0.018	0.006	0.123	0.069	0.246
> 300 Beds (DH)	0.027	0.004	0.017	0.004	0.138	0.072	0.263
Private							
Small (< 50 Beds)	0.032	0.000	0.024	0.006	0.136	0.113	0.312
Medium (50 - 100 Beds)	0.023	0.010	0.023	0.007	0.162	0.145	0.371
Large (101 - 300 Beds)	0.036	0.007	0.039	0.011	0.205	0.225	0.523
Very Large (> 300 Beds)	0.036	0.010	0.035	0.010	0.224	0.228	0.542
Municipality							
Hospital	0.036	0.002	0.020	0.004	0.116	0.074	0.253
Maternity Homes	0.081	0.000	0.024	0.003	0.114	0.065	0.288
Speciality Hospitals							
Eye	0.000	0.002	0.015	0.005	0.023	0.024	0.070
Dental	0.004	0.002	0.003	0.000	0.012	0.018	0.039
Infectious Disease	0.000	0.007	0.021	0.006	0.125	0.078	0.236
Leprosy	0.007	0.008	0.016	0.007	0.123	0.074	0.234
Cancer	0.004	0.004	0.027	0.002	0.136	0.067	0.240
TB	0.000	0.006	0.020	0.006	0.102	0.050	0.183

B. Non-Bedded Facilities per Patient per Day							
	CAT 1	CAT 3	CAT 4	CAT 5	CAT 6	CAT 7	Total
Government							
Rural	0.000	0.000	0.004	0.000	0.003	0.025	0.032
Urban	0.000	0.000	0.004	0.000	0.003	0.025	0.032
Municipality							
ESOPD	0.000	0.000	0.005	0.000	0.003	0.016	0.024
Sub Centres	0.000	0.000	0.005	0.000	0.005	0.022	0.032

C. Pathological Laboratories per Sample per Day							
	CAT 1	CAT 3	CAT 4	CAT 5	CAT 6	CAT 7	Total
Large	0.005	0.006	0.004	0.000	0.004	0.019	0.038
Medium	0.000	0.007	0.003	0.000	0.002	0.019	0.031
Small	0.000	0.006	0.003	0.000	0.002	0.019	0.030

On the basis of these average quantities, annual generation of BMW in three categories in the state has been quantified.

A. Bedded HCUs

In case of bedded HCUs, district-wise BMW generation has been calculated considering average generation per bed per day of that specific category, total bed strength of HCUs of that category and their functioning for 365 days in a year. But in special category there are particularly Eye and Dental Hospitals, which generally remain closed on Sundays and holidays. In those cases their functioning has been calculated on the basis of functioning of 300 days per year. Generally these HCUs have beds for day care

B. Non-Bedded HCUs

In case of non-bedded government HCUs there are 10356 rural and 2100 urban immunization units as per data furnished by the Health & Family Welfare Department. Around 50 sessions are held in each unit in a year (vide Memo No. 482/IS-74/2001 (Pt IV) dated 12.11.10). In each session average number of injection of vaccines administered has been assessed as 30.

In case of non-bedded HCUs, under municipalities (in urban areas), average number of patients per working day has been taken as 50. They function twice in a week. Hence their amount of generation has been calculated on the basis of functioning of 104 days in a year. In case of Extended Special Out-Patient Department (ESOPD) of the municipalities, average number of patients per working day has been considered as 30. Generation of BMW has been calculated considering their functioning everyday except Sundays and holidays i.e, approximately 300 days.

Names of these non-bedded HCUs have not been mentioned in the Inventory chapter. However, district-wise number of non-bedded government HCUs has been ascertained from data available from Health & Family Welfare Dept (reference cited above). District-wise number of municipal sub-centres and ESOPD has been ascertained from State Urban Development Agency (vide SUDA-Health/539/09/648 dated 23.2.2010).

C. Pathological Laboratories

Among different kinds of diagnostic centres (data available from WBPCB) only pathological laboratories have been considered for quantification of BMW generation. Diagnostic centres exclusively deal with X-Ray, Scan, other radiological examinations etc. have been excluded considering they do not produce BMW. However centres having both radiological and pathological examination facilities have been considered as pathological laboratories.

Efforts were made to figure out exact number of different sizes of pathological laboratories viz., Large, Medium and Small. Data available with WBPCB, State Health & Family Welfare Office and different CMOH offices were consulted but required figures could not be ascertained. Though average generation of BMW per test sample could be ascertained from quantification study of selected pathological laboratories, average number of tests in such laboratories could not be ascertained. However district-wise names and numbers of diagnostic centres including pathological laboratories were available from WBPCB data. To assess generation of BMW in pathological laboratories two sets of assumptions have been made:

- (a) Number of tests for Large - 2000 per month
 Medium - 500 per month
 Small - 250 per month
- (b) 4 Large laboratories in Kolkata, 1 Large laboratory in Siliguri.
 In other districts 20% medium and 80% small of total number of pathological laboratories.

Other Major Sources

Data from WBPCB includes only one veterinary hospital in the state namely Institute of Animal Health and Veterinary Biologicals in Kolkata, where quantification study has been conducted. There may be other HCUs of this category but authentic source was not available. This has not been included in summary quantification.

WBPCB data shows two forensic laboratories in Kolkata one belongs to State Government and the other belongs to Central Government. Due to some problems regarding BMW management, the authority of the State Forensic Laboratory requested the survey team to visit. Quantification could not be made due to the mode

of preservation of waste in such laboratories. However an average generation of 250 Kg of Cat 1 BMW per month has been ascertained from the authority but has not been included in summary. Other major sources like health camps, blood banks, blood donation camps, private clinics also remain excluded in the Summary Quantification.

District-wise Detailed Quantification Summary

District-wise quantification summary in detail may be seen in Summary Quantification annexure. Some salient features will be available from the following:

Bedded HCUs including government, other government, private and specialty HCUs:

Annual BMW Generation in West Bengal							
A. Bedded HCUs (Wt. in Kg)							
Districts	CAT 1	CAT 3	CAT 4	CAT 5	CAT 6	CAT 7	Total Generation in a Year
Bankura	32582	5857	27496	7172	179709	110520	363336
Birbhum	21285	3888	19792	4959	110597	62686	223208
Burdwan	97770	13586	78127	19662	482994	323740	1015879
Coochbihar	17647	3277	14036	3679	91318	56046	186004
Dakshin Dinajpur	8409	1251	6189	1485	37443	20877	75654
Darjeeling	44025	7176	36208	9084	236567	157365	490425
East Midnapore	27852	3413	22919	5667	129549	87888	277287
Hooghly	71171	7986	54797	14033	322417	230937	701341
Howrah	51231	5349	39770	10481	234985	161442	503258
Jalpaiguri	25909	2999	20379	5111	122048	77004	253450
Kolkata	288995	45432	235047	60566	1564382	1200492	3394913
Malda	17606	2504	14259	3393	79750	48071	165582
Murshidabad	39927	5911	32505	8257	190030	117140	393771
Nadia	48638	9357	50264	13525	288496	178868	589148
North 24 Parganas	97738	13472	78558	20558	468521	344206	1023053
Purulia	21083	4546	19253	5345	113363	72470	236060
South 24 Parganas	39765	4759	32837	8476	181904	134266	402008
Uttar Dinajpur	8179	1403	6963	1679	37573	22462	78258
West Midnapore	44816	6106	37428	9282	223073	140388	461093
Gr. Total	1004627	148271	826828	212414	5094720	3546869	10833729

Thus total BMW generation in bedded HCUs amounts to **11000 MT** (approx) per year

Non-Bedded HCUs including government and municipality HCUs:

Annual BMW Generation in West Bengal							
B. Non-Bedded HCUs (Wt. in Kg)							
Districts	CAT 1	CAT 3	CAT 4	CAT 5	CAT 6	CAT 7	Total Generation in a Year
Bankura			3780		2647	23175	29602
Birbhum			3576		2588	21416	27579
Burdwan			12093		9914	64270	86277
Coochbihar			3021		2189	18071	23281
Dakshin Dinajpur			2034		1499	11863	15396
Darjeeling			4017		3402	20724	28144
East Midnapore			5055		3618	30515	39188
Hooghly			10761		8925	56094	75780
Howrah			7255		5834	39079	52169
Jalpaiguri			4323		3127	25552	33002
Kolkata			5840		5086	28830	39756
Malda			3665		2618	22028	28312
Murshidabad			6149		4390	37116	47655
Nadia			4932		3797	27997	36726
North 24 Parganas			21126		18195	105600	144920
Purulia			3301		2315	20209	25825
South 24 Parganas			9968		7607	56804	74380
Uttar Dinajpur			2891		2148	16818	21857
West Midnapore			6930		5118	40704	52752
Gr. Total			120718		95017	666865	882600

Thus total BMW generation in non-bedded HCUs amounts to **883 MT** (approx) per year.

Pathological Laboratories:

Annual BMW Generation in West Bengal							
C. Pathological Centres (Wt. in Kg)							
Districts	CAT 1	CAT 3	CAT 4	CAT 5	CAT 6	CAT 7	Total Generation in a Year
Bankura		1588	807		509	4920	7824
Birbhum		2272	1154		729	7038	11193
Burdwan		3088	1569		990	9567	15214
Coochbihar		1103	560		354	3417	5434
Dakshin Dinajpur		265	134		85	820	1304
Darjeeling	120	1391	725		495	4307	7037
East Midnapore		2559	1300		821	7927	12606
Hooghly		7258	3687		2327	22481	35753
Howrah		3221	1636		1033	9977	15866
Jalpaiguri		2294	1165		736	7107	11302
Kolkata	480	11094	5706		3751	34357	55389
Malda		375	190		120	1162	1847
Murshidabad		2603	1322		835	8063	12823
Nadia		4103	2084		1316	12710	20213
North 24 Parganas		6883	3496		2207	21320	33906
Purulia		838	426		269	2597	4130
South 24 Parganas		2052	1042		658	6355	10106
Uttar Dinajpur		1059	538		340	3280	5216
West Midnapore		3331	1692		1068	10318	16409
Gr. Total	600	57378	29234		18641	177720	283574

Thus total BMW generation in pathological laboratories amounts to **300 MT** (approx) per year.

District-wise total generation of BMW in West Bengal :

Annual BMW Generation in West Bengal							
Districtwise generation							
Districts	CAT 1	CAT 3	CAT 4	CAT 5	CAT 6	CAT 7	Total Generation in a Year
Bankura	32582	7446	32083	7172	182865	138615	400763
Birbhum	21285	6161	24522	4959	113914	91140	261981
Burdwan	97770	16674	91790	19662	493898	397577	1117369
Coochbihar	17647	4380	17617	3679	93861	77534	214719
Dakshin Dinajpur	8409	1515	8357	1485	39027	33560	92354
Darjeeling	44145	8567	40950	9084	240464	182396	525606
East Midnapore	27852	5972	29274	5667	133987	126329	329081
Hooghly	71171	15244	69244	14033	333669	309512	812874
Howrah	51231	8570	48661	10481	241852	210498	571293
Jalpaiguri	25909	5293	25868	5111	125911	109663	297754
Kolkata	289475	56526	246593	60566	1573219	1263680	3490058
Malda	17606	2879	18114	3393	82489	71261	195742
Murshidabad	39927	8514	39977	8257	195255	162319	454249
Nadia	48638	13460	57281	13525	293608	219575	646086
North 24 Parganas	97738	20355	103180	20558	488924	471125	1201879
Purulia	21083	5384	22980	5345	115947	95276	266014
South 24 Parganas	39765	6811	43848	8476	190169	197425	486494
Uttar Dinajpur	8179	2462	10392	1679	40061	42560	105332
West Midnapore	44816	9437	46050	9282	229260	191410	530255
Gr. Total	1005227	205649	976780	212414	5208378	4391455	11999902

Total Generation of BMW in Bedded, Non-Bedded and pathological Laboratories :

Annual BMW Generation in West Bengal							
in Bedded, Non-bedded HCUs and Path Labs (Wt in Kg)							
Types of HCUs	CAT 1	CAT 3	CAT 4	CAT 5	CAT 6	CAT 7	Total Generation in a Year
Bedded	1004627	148271	826828	212414	5094720	3546869	10833729
Non-bedded			120718		95017	666865	882600
Path Lab	600	57378	29234		18641	177720	283574
	1005227	205649	976780	212414	5208378	4391455	11999902

Thus total BMW generation in the state amounts to **12000 MT** (approx) per year.

District-wise generation of BMW in West Bengal at a glance :

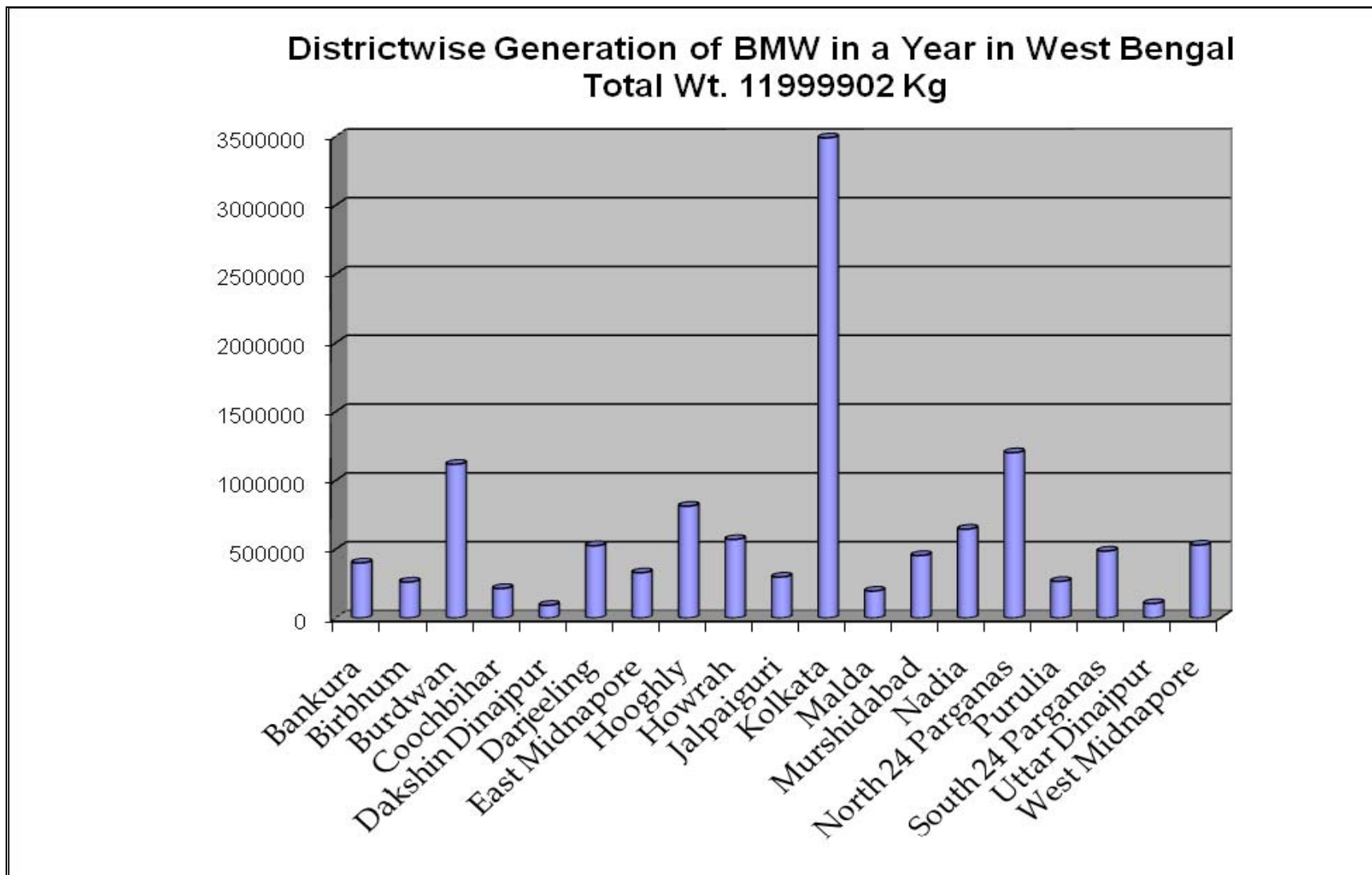

Growth Rate:

Department of Health & Family Welfare, Govt. of West Bengal has estimated increase in number of population in the state from 2008 to 2016 for developing strategy to expand health care facilities:

Projected Population of West Bengal 2008 - 2016									
in '000									
Year	Total			Urban			Rural		
	Persons	Males	Females	Persons	Males	Females	Persons	Males	Females
2008	86995	44820	42174	24642	12879	11763	62353	31941	30412
2009	87839	45234	42605	24926	13008	11918	62913	32226	30687
2010	88669	45640	43029	25207	13135	12072	63462	32505	30957
2011	89499	46045	43454	25489	13262	12227	64010	32783	31227
2012	90320	46445	43874	25769	13388	12381	64551	33057	31494
2013	91122	46836	44287	26045	13511	12534	65077	33325	31752
2014	91920	47223	44697	26320	13634	12686	65600	33589	32011
2015	92725	47613	45112	26598	13757	12841	66127	33856	32271
2016	93550	48012	45538	26883	13883	13000	66667	34129	32538

Source : http://www.wbhealth.gov.in/Statistics%20_Html/2007_2008/1/1_21.html

In the above estimate it is seen that annual increase in population has been estimated as 0.87% to 0.94% per year. Though there is a huge shortfall in number of existing basic health care facilities with respect to population, a very conservative estimate is made regarding increase of BMW generation i.e, 1% increase per year up to 2020.

Hence the estimated increase may be seen in the following table and chart:

Project Increase in BMW Generation	
Year	Wt in Kg
2009	11999902
2010	12119901
2011	12241100
2012	12363511
2013	12487147
2014	12612018
2015	12738138
2016	12865520
2017	12994175
2018	13124117
2019	13255358
2020	13387911

Thus projected annual BMW generation in 2020 may be estimated as 13500 MT.

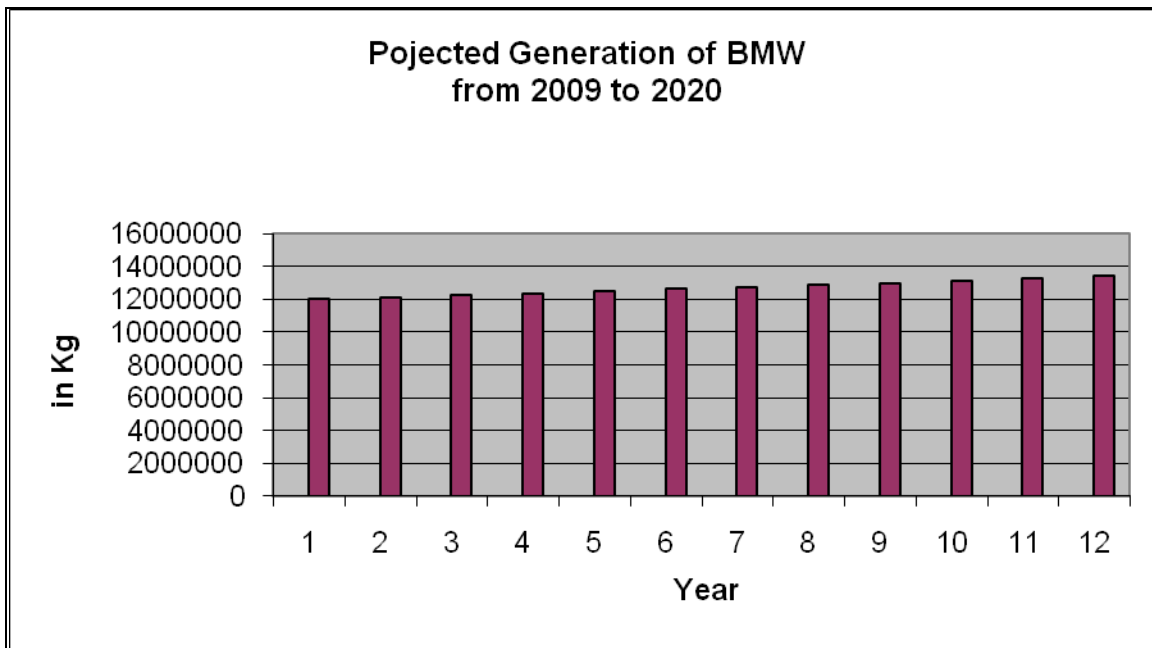

Proportion of BMW generated from different sources :

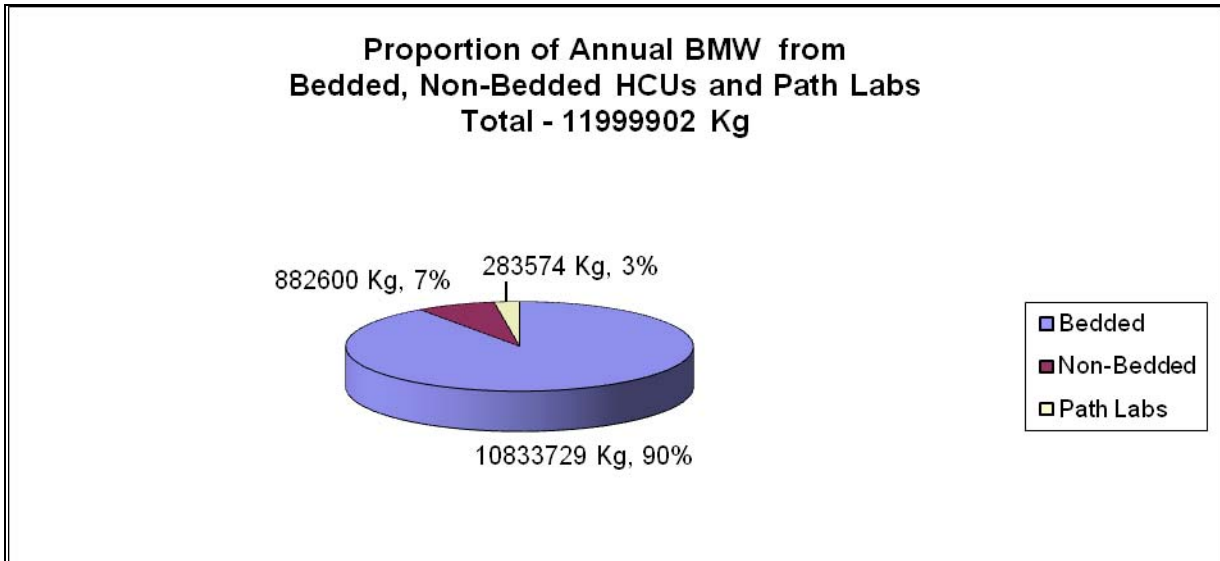

It is important to note that 7% of total BMW is generated in rural government and urban municipal non-bedded HCUs. These facilities are still not connected with any treatment facility. Individually each of these HCUs generate little amount of BMW but by their sheer number, as a whole, they produce a huge amount of BMW. We shall discuss how these facilities can be connected to treatment facilities in a following chapter 'Other Options'.

Proportion of Recyclable and Non-Recyclable BMW :

Generally plastic, glass and metal in BMW are recyclable items while others are considered as non-recyclable (though cloth, linen etc. may be recycled). For calculation of proportion of recyclable and non-recyclable items only categories 4 and 7 have been included in recyclable and categories 1, 2, 3, 5 and 6 have been considered as non-recyclable.

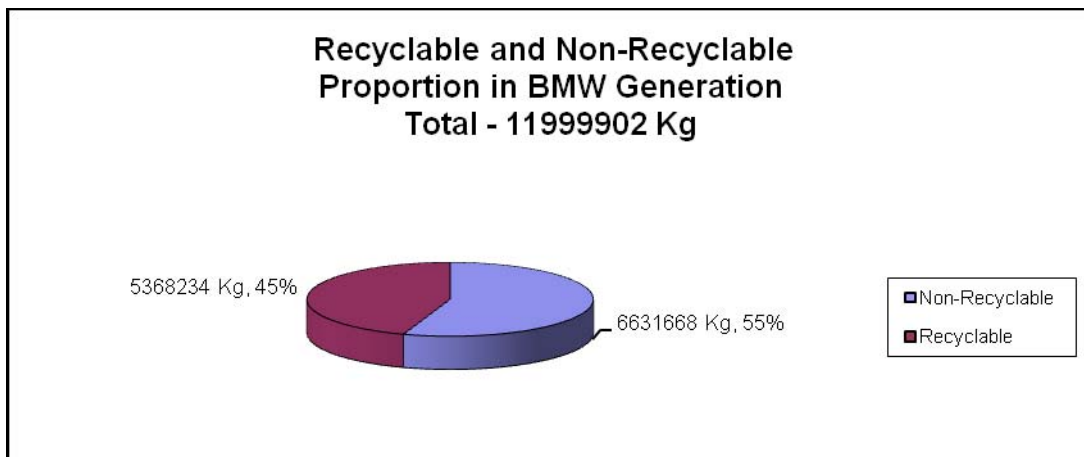

Considering the total waste from different categories of HCUs, it may be noted that 45% of BMW is found recyclable whereas 55% is found non-recyclable. However in case of bedded HCUs proportion of soiled waste is more. In bedded HCUs proportion of recyclable waste is only 40% of total BMW generated. Again it has been estimated that 30% of recyclable waste in bedded HCUs is composed of IV fluid bottles

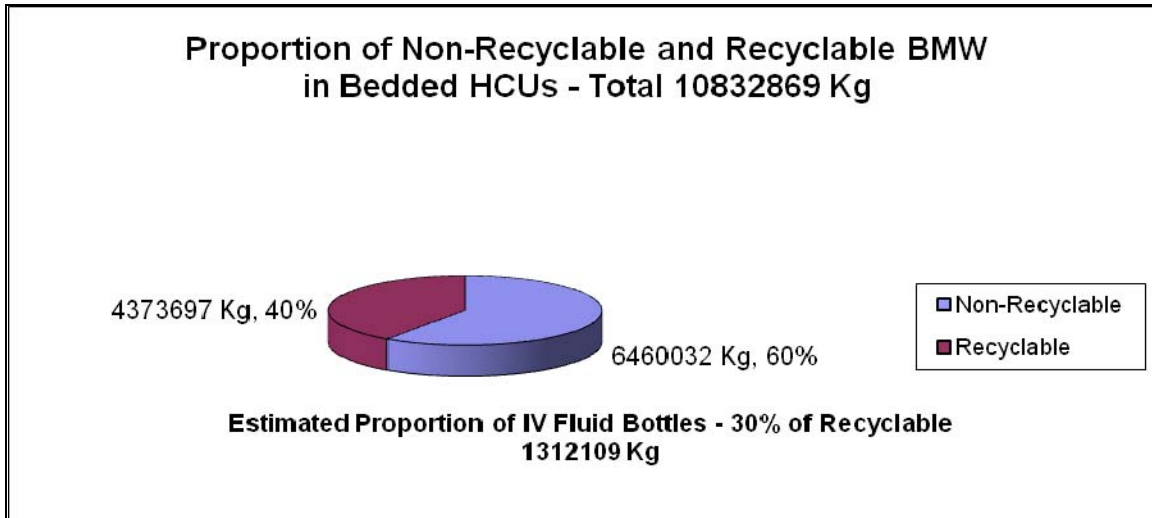

It is interesting to note that in case of non-bedded facilities bulk of the BMW (around 90%) is recyclable.

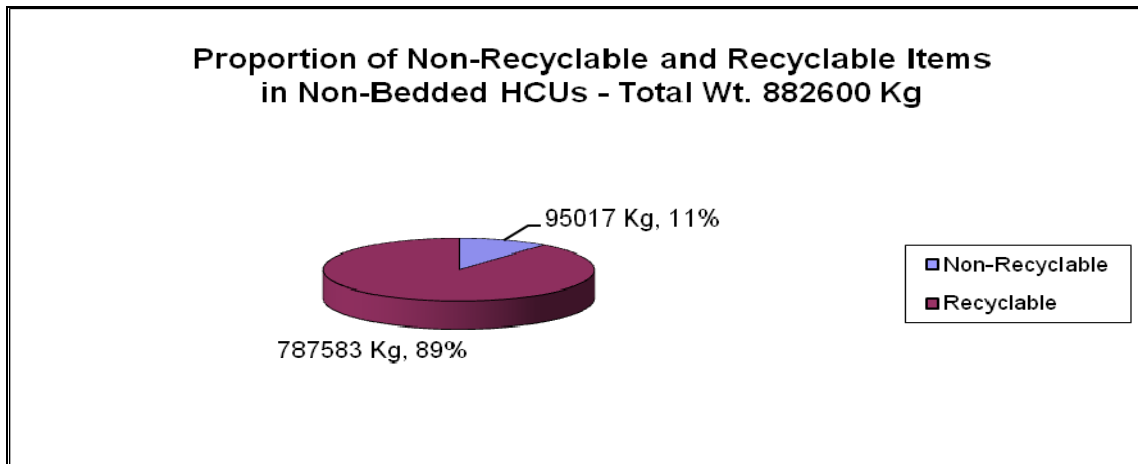

This indicates that a major portion of BMW from non-bedded HCUs may go to recycling market without being treated if these are not brought under coverage of treatment facilities. Treatment facilities also would welcome the nature of this BMW as there is a common complaint of all the facility operators that they receive disproportionately larger amount of non-recyclable BMW items. So their revenue earning through sale of treated recyclable items gets reduced.

**PRESENT STATUS OF
TREATMENT AND DISPOSAL**

Treatment and Disposal of Bio-Medical Waste in West Bengal

Efforts towards safe and proper treatment and disposal of bio-medical waste in West Bengal date back to the 1990s, even prior to the introduction of the Bio-Medical Waste (Management and Handling) Rules, 1998.

The first initiative extending to the whole of the state was taken by the Health and Family Welfare Department of the Government of West Bengal for management of bio-medical waste in the secondary level (District, Sub-Divisional, State-General and Rural) Government hospitals under West Bengal State Health System Development Project (WBHSDP). With the introduction of the BMW Rules in 1998 WBPCB became the designated authority to approve and monitor the BMW management in the state. The years that followed witnessed establishment of a number of treatment and disposal facilities with systems of segregated collection, treatment and disposal of bio-medical waste that covers a major part of the state.

During the first phase of this period two common bio-medical waste treatment facilities at Kalyani Jawharlal Nehru Memorial Hospital and Diamond Harbour Sub-divisional Hospital, several stand alone treatment facilities and a good number of in-campus disposal pits were installed in some government hospitals. Efforts were also made to involve municipalities and municipal corporations to develop disposal facilities to bury a portion of bio-medical waste. Some of the municipalities and Kolkata Municipal Corporation constructed common burial pits to dispose of biomedical waste.

But the practice of disposal of all categories of bio-medical waste into common or in-campus pits did not corroborate with the BMW Rules, 1998. In course of time all the municipal common pits became defunct. In-campus pits in government hospitals had also been misused and most of those are now filled up.

At later stage several common bio-medical waste treatment and disposal facilities (CBWTF) in compliance with the Rules have come up. These are privately owned facilities. But apart from Kolkata and Howrah, most of the health care units were out of waste management regime till 2007.

Initiative of WBPCB for improvement of compliance of the Rules

The West Bengal Pollution Control Board had been pursuing individual health care units as well units under the Health & Family Welfare Department (H&FW), Govt. of WB for introduction of bio-medical waste management at all levels. Repeated requests were made for submission of application for 'Bio-medical Waste Authorization', 'Consent to Operate' and to ensure treatment of the Bio-medical waste.

A monitoring committee to oversee the implementation of the Bio-medical Waste Management & Handling Rules in the State Govt. Hospitals had been formed involving the Joint Director (PH & CD), Health & Family Welfare Dept., Govt. of WB, representatives of WBPCB, Kolkata Municipal Corporation & Environment Dept., Govt. of WB.

A number of meetings had been conducted by the Board with the H&FW Dept., Govt. of WB and Chief Medical Officers of Health of various districts to improve compliance status with respect to the submission of the BMW authorisation application, segregation at source and ensuring treatment of BMW.

Of late, during the study period, the H&FW Dept., Govt. of W.B. took a policy decision to make every government health care units (up to PHC level) responsible for signing agreement with the respective CBWTF of the region. The department also provided budgetary provision for all the government health care units for management cost of BMW vide its Circular No. HF/O/MS/316/W-99/2008 dtd 28.5.09. Authority to handle the budgetary provision has been conferred to the heads of the HCUs upto Block Medical Health Officer (BMOH) level.

Simultaneously another important policy was adopted that the CMOH will not issue health license under Clinical Establishment Act to private health care units, until and unless the units possess valid authorisation of the WBPCB and WBPCB will not issue authorisation to the health care unit unless they ensure treatment of their BMW either by their own facilities or through joining the available common treatment facility.

Through these initiatives the compliance status of the health care units, both Govt. & Private, has improved a lot. More and more health care units are joining the CBWTFs and the situation is in rapid transition.

Present Status of BMW Treatment and Disposal Facilities

Study was conducted to assess the functioning of the treatment and disposal facilities, which are in operation at present.

Study Objective:

1. Review of the existing segregation, treatment and disposal practices.
2. Preparation of inventory of treatment and disposal facilities in West Bengal.
3. Locating coverage area or unit of the facilities.
4. Recording the process of treatment of waste different categories.
5. Quantify t of waste of different categories treated by the facilities.

6. Compare the quantity of treatment with respect to capacity of the facilities and waste generated within specific areas.
7. Assess further requirement of treatment facilities with reference to location.

Detailed Methodology:

1. All the treatment facilities (both common and stand alone) of the state have been visited and records have been collected to assess the status of treatment and disposal at various levels.
2. Records regarding regularity of functioning, quantity of treatment and disposal were checked and collected.
3. Records were corroborated with the report submitted to WBPCB by the treatment facilities wherever possible.

Prescribed Procedure of Treatment as per BMW Rules:

Before assessing the status of treatment and disposal facilities let us have a look into the prescribed procedure for different categories of BMW in Bio-medical Waste (Management and Handling) Rules 1998 :

Category	Type of Waste	Option
Category 1	Human Anatomical	Incineration, Deep Burial
Category 2	Animal Waste	Incineration, Deep Burial
Category 3	Microbiology & Biotechnology	Autoclaving, Microwave, Incineration
Category 4	Sharps	Chemical Disinfection / Autoclave / Microwave & Mutilation / Shredding
Category 5	Discarded Medicines, Cytotoxic Drugs	Incineration / Destruction & Disposal in Secured Landfill
Category 6	Solid (soiled)	Incineration / Autoclaving / Microwave
Category 7	Solid (recyclable)	Chemical Treatment / Autoclaving/ Microwave
Category 8	Liquid	Chemical Treatment / Discharge in Drains
Category 9	Incineration Ash	Disposal in Secured Landfill
Category 10	Chemical (Liquid & Solid)	Chemical Treatment and Discharge in Drains for Liquid and Disposal in Secured Landfill for Solid

Colour Coding and Type of Containers for Segregation and Disposal of BMW

The Rules prescribe different colour codes of bags and containers (multiple options) for particular category of waste in relation to their treatment and disposal option. To simplify the operation of treatment and disposal, this is particularly important to club together different categories in some common colours matching with respective treatment and disposal options. However, let us have a look at the prescribed options before assessing the existing practices.

Colour Coding	Type of Container - Waste Category	Treatment Options
Yellow	Plastic Bag - Cat 1, 2, 3 and 6	Incineration / Deep Burial
Red	Disinfected Container / Plastic Bag - Cat 3, 6 and 7	Autoclaving / Microwaving / Chemical Treatment
Blue / White	Disinfected Container / Plastic Bag - Cat 4 and 7	Autoclaving / Microwaving / Chemical Treatment and Destruction / Shredding
Black	Plastic Bag - Cat 5, 9 and 10 (solid)	Disposal in Secured Landfill

Existing Practices of Segregation, Treatment and Disposal

As stated above, BMW management was first initiated by the Dept. of Health & Family Welfare (DoH&F) under the WBHSDP mostly in secondary level government hospitals. Later the system was extended to some selected Block Primary Health Centres (BPHCs) and Primary Health Centres (PHCs). There was no option for incineration in prescribed system of WBHSDP. As there was no incineration, issue of disposal of incineration ash (Cat 9) did not arise. Treatment of liquid waste (Cat 8) has not been taken up at all, in absence of infrastructural support (like unidirectional drainage system etc.) in almost all the government hospitals. This holds good for liquid portion of chemical waste (Cat 10). Solid portion of chemical waste (Cat 10) was also not taken into account as solid chemical waste is rarely separated. Procedure of segregation was followed as below :

Colour Coding	Container - Waste Category	Treatment Options
Yellow	Plastic Bag - Cat 1, 2	Burial in campus or common pit
Red	Plastic Bag - Cat 3, 6 and 7	Autoclaving / Microwaving / Burial in campus or common pit
Blue	Puncture Proof Container / Plastic Bag - Cat 4	Chemical Treatment/ Autoclaving / Microwaving

The system had one major departure from the Rules. The bulk amount of BMW is composed of Cat 6 and Cat 7. Among these two, Cat 7 is composed mainly of plastic waste and this should not go into burial pit according to the Rules. But WBHSDP procedure allowed it where treatment facilities were not available.

The Flow Chart of the procedure suggested by WBHSDP for HCUs having treatment facility is presented below :

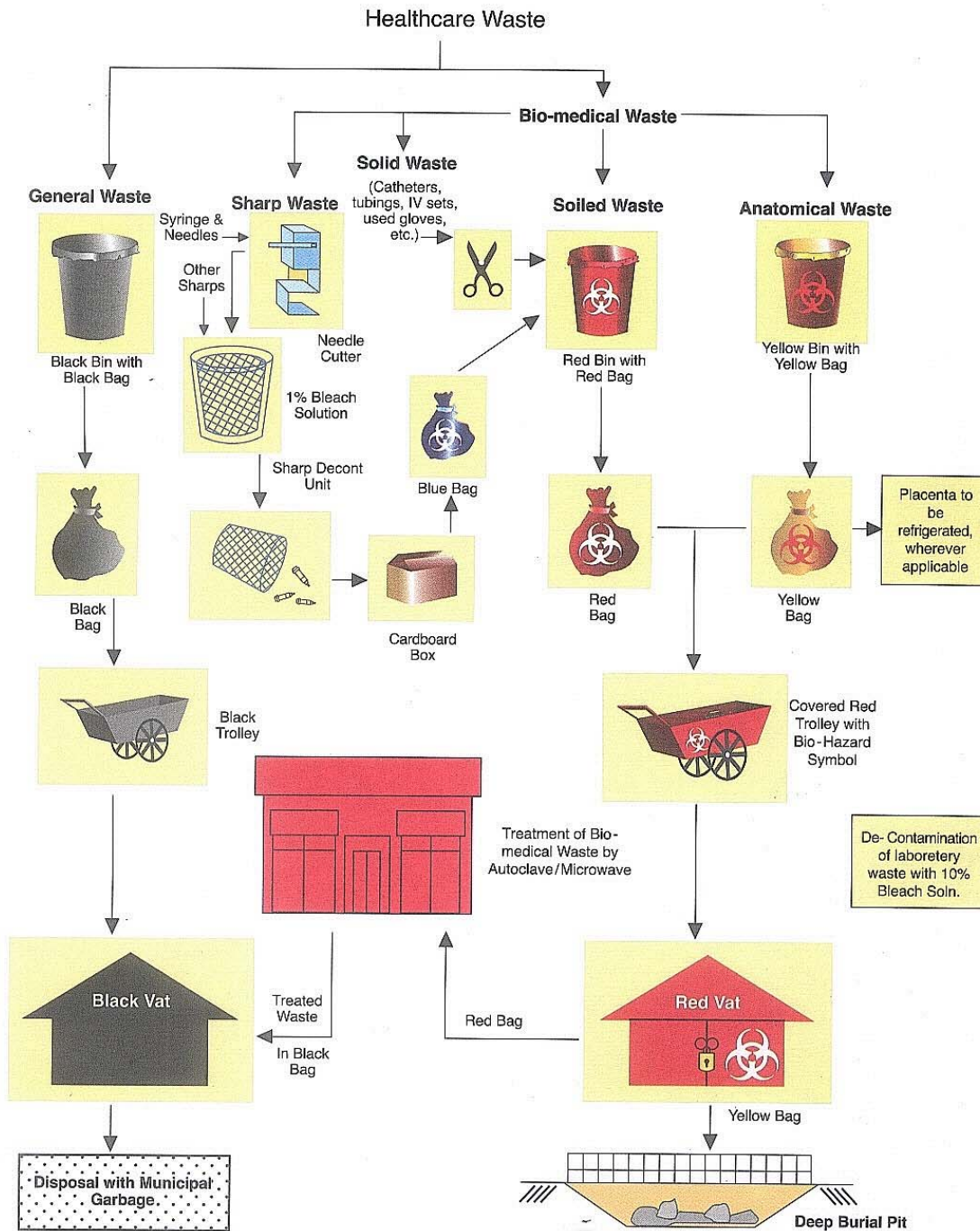

Apart from the WBHSDP procedure, there was no standard operational procedure of segregation and colour coding for other categories of health care units. Since installation of the private common bio-medical waste treatment facilities (CBWTF), standard procedure is slowly being established. Here also Cat 8 and Cat 10 have been excluded as stated above. The prescribed procedure of CBWTFs is as follows:

Colour Coding	Type of Container - Waste Category	Treatment Options
Yellow	Plastic Bag - Cat 1, 2, 3, 5, 6	Incineration
Blue	Plastic Bag - Cat 7	Autoclaving
White	Puncture Proof Container - Cat 4	Chemical Treatment/ Autoclaving
Black	Plastic Bag - Cat 9	Disposal in Secured Landfill

**FLOW CHART FOR BMW MANAGEMENT
AT COMMON BIOMEDICAL WASTE TREATMENT FACILITY**

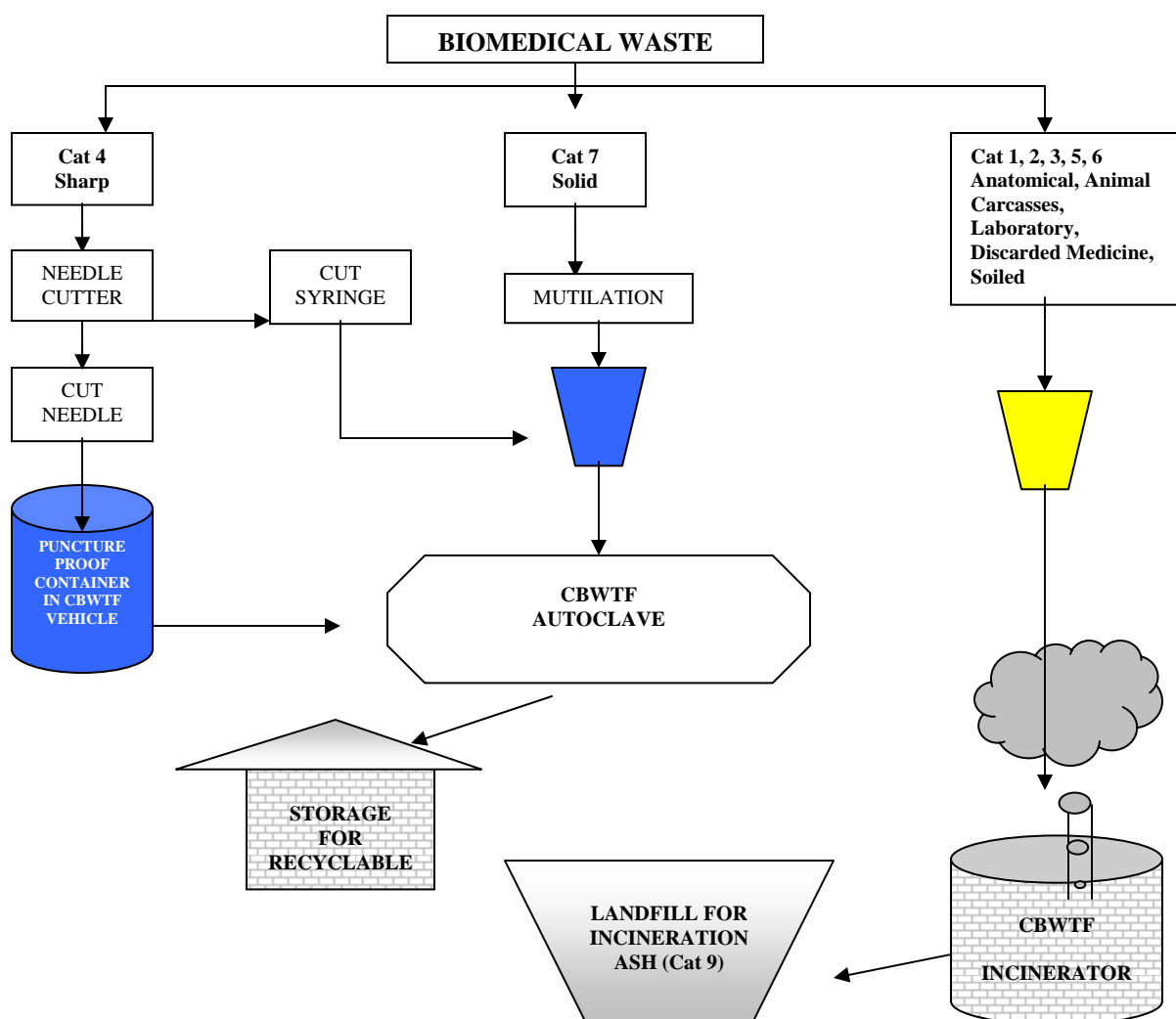

But the former procedure of segregation as per guideline framed by the WBHSDP is still being followed in many government HCUs having common and stand-alone treatment facilities where incinerator is not available. Of course, the procedure of segregation as per guideline framed under the WBHSDP is gradually being phase out.

Common Bio-medical Waste Treatment Facilities (CBWTF)

At present there are 7 CBWTFs in the state. **Five** among those are larger facilities having capacity to treat BMW of beds ranging from 15000 to 30000 per day. These are all private facilities. They have incinerators, autoclaves and shredders. Their areas of operation cover specific districts ranging from 2 to 6. There are two other small CBWTFs attached with Kalyani JNM Hospital and Diamond Harbour Sub-divisional Hospital. The first one has an autoclave whereas the second one has a microwave. These are small facilities catering some health care units situated within the concerned municipal area. Their capacity is not derived with bed unit. However, exact number of beds they cater, has been ascertained. Only one CBWTF that is West Bengal Waste Management Facility has designated secured landfill for disposal of incineration ash (Cat 9). All other facilities having incinerator send incineration ash to this facility for disposal.

Waste Bengal Waste Management Ltd., Haldia has a common incinerator which is to be used for both hazardous and bio-medical waste. Apart from the incinerator they have the waste Autoclave and Shredder machine.

All the three **SembRamky Facilities** operate in prescribed manner. These facilities incinerate and disinfect according to the colour of the bags / containers they receive.

Greenzen Facility started operation in March 2009 and is having very little amount of waste. But its customer base is expanding. Still it appears inconvenient to cover 6 districts by a single facility.

For all these common facilities, there is no further practice of secondary segregation inside the facilities. As almost all the HCUs dispose of mixed waste, a large amount of plastic items particularly PVC medical equipments find their way in incinerators. According to the Rules chlorinated plastic should not be incinerated. Moreover a slight amount of mercury may be present in BMW, as there is no appropriate arrangement of source segregation or collection of mercury waste. Incineration of PVC and mercury waste may be fatal for human health. Monitoring on presence of dioxin and mercury in the vicinity of these facilities may be conducted.

Common Bio-medical Waste Treatment Facilities in West Bengal with capacity, coverage and operational status						
Name of the Facility	Coverage Area	Capacity by Bed	Technology Used	Categories Treated and disposed	Waste Treated in 2009 in Kg *	Comments
Waste Bengal Waste Management Ltd. Haldia	East Midnapore	20000	Incineration, Autoclave	Cat 1, 2, 3, 4, 5, 6, 7, 9	37171	Printer of Autoclave is not functioning, Incineration is to be performed with industrial waste
	West Midnapore					
SembRamky Environmental Management Pvt. Ltd Howrah Facility	Kolkata	30000	Incineration, Autoclave	Cat 1, 2, 3, 4, 5, 6, 7	1791613	Printer is functioning
	Howrah					
	S. 24 Parganas					
SembRamky Environmental Management Pvt. Ltd Kalyani Facility	Murshidabad	30000	Incineration, Autoclave	Cat 1, 2, 3, 4, 5, 6, 7	724425	Printer is functioning
	Nadia					
	N. 24 Parganas					
	Hooghly					
SembRamky Environmental Management Pvt. Ltd Durgapur Facility	Bankura	30000	Incineration, Autoclave	Cat 1, 2, 3, 4, 5, 6, 7	190888	Printer is functioning
	Burdwan					
	Birbhum					
	Purulia					
Greenzen Bio Pvt. Ltd, Phulbari, Jalpaiguri	Coochbihar	15000	Incineration, Autoclave	Cat 1, 2, 3, 4, 5, 6, 7	115075	Printer is functioning
	Jalpaiguri					
	Darjeeling					
	Uttar Dinajpur					
	Dakshin Dinajpur					
	Malda					
Kalyani Jawharlal Nehru Memorial Hospital, Nadia	Vicinity	804**	Autoclave	Cat 3, 4, 6, 7	2856	Printer is not functioning
Diamond Harbour Sub-Divisional Hospital, South 24 Parganas	Vicinity	196**	Microwave	Cat 3, 4, 6, 7	14400	Printer is not functioning

* Amount of waste treated in the facilities in 2009 has been ascertained from the report submitted to the WBPCB.

** Capacity of these facilities in relation to bed strength could not be ascertained. However actual number of beds catered by these facilities has been ascertained from respective HCUs.

Stand Alone Bio-medical Waste Treatment Facilities

There are 14 operating stand alone facilities in the state. Among these 10 facilities are owned by the Health & Family Welfare Dept., one belongs to Durgapur Steel Plant two are privately owned and one belongs to National Institute of Cholera and Enteric Diseases (NICED), a central government research organisation. All these facilities treat BMW generated in self units. All these units have autoclaves except in case of two facilities. Medical College, Kolkata has a microwave. NICED has an incinerator (this is the only on-site incinerator in the purview of the study).

All the district hospitals owned by the health department were supposed to have their own stand alone facilities. But only those facilities which were functioning during the study period have been taken into account.

These facilities treat varied categories of BMW. Facilities of Siuri Sadar Hospital, Coochbihar MJN Hospital, Imambarā Sadar Hospital, Malda DH, Murshidabad DH and Shaktinagar Hospital DH, having autoclaves, treat BMW categories 3, 4, 6, 7. The respective units also generate Cat 1 but this category cannot be treated in autoclave. Cat 1 should be disposed of in burial pits as per Rules. But all these units are in municipal areas where common burial pits were either constructed or were to be constructed but now none is functioning. There is no arrangement of campus pit also. Hence disposal of Cat 1 in these units is not done in proper manner. It has been ascertained that some of the HCUs have arrangements with a pharmaceutical company (Albert Davis) who collects placenta (part of Cat 1 - only from first or second babies of mothers) but any dependable record regarding this was not available anywhere. However, in accordance with the departmental order dated 28.5.2009, all these facilities will have to enter into agreement with respective CBWTFs, when problem of disposal of Cat 1 will be solved.

At present Howrah DH, Barasat DH, Burdwan MCH, Medical College, DSP Hospital, Arobinda Seva Kendra, Vivekananda Mission Ashram Netra Niramay Niketan and NICED Kolkata use their facilities for treatment of a part of their BMW. They have agreement with respective CBWTF for the rest portion of BMW. In NICED, where examinations are carried on living specimens, incinerator is used only for treatment of Cat 2. All other categories of BMW (Cat 3, 4, 6 and 7) are handed over to CBWTF. In seven other facilities only Cat 4 and 7 are treated in autoclaves. All other categories of BMW (Cat 1, 3, 5 and 6) are handed over to CBWTF.

Amount of waste treatment in these facilities have been calculated on the basis of average generation in those categories and bed strength of respective HCUs and the categories of BMW they treat. Only in case of NICED (no bed strength) calculations have been made on the data of incineration ash (as supplied to WBPCB by NICED), projecting to total of Cat 2 treated.

Treatment in Stand Alone BWT Facilities						
Unit	Location (District)	Bed Strength	Amount of BMW Treatment in a Year in Kg	Technology Used	Categories Treated	Comments
Siuri Sadar Hospital	Birbhum	500	42196.626	Autoclave	Cat 3, 4, 6, 7	Printer Not Functioning
Coochbihar MJN Hospital	Cooch Behar	400	33757.301	Autoclave	Cat 3, 4, 6, 7	Printer Not Functioning
Imambara Sadar Hospital	Hooghly	610	51479.883	Autoclave	Cat 3, 4, 6, 7	Not properly functioning
Howrah District Hospital	Howrah	544	17705.861	Autoclave	Cat 4, 7	Printer Not Functioning
Malda District Hospital	Malda	600	50635.951	Autoclave	Cat 3, 4, 6, 7	Printer Not Functioning
Murshidabad District Hospital	Murshidabad	391	32997.761	Autoclave	Cat 3, 4, 6, 7	Printer Not Functioning
Shakti Nagar District Hospital	Nadia	895	75531.960	Autoclave	Cat 3, 4, 6, 7	Printer Not Functioning
Barasat District Hospital	North 24 Pgs	500	16273.770	Autoclave	Cat 4, 7	Printer Not Functioning
Vivekananda Mission Ashram Netra Niramay Niketan	East Midnapore	100	6132.000	Autoclave	Cat 4, 7	Printer working
Burdwan MCH	Burdwan	1099	39546.150	Autoclave	Cat 4, 7	Printer working
DSP Hospital	Burdwan	590	19203.048	Autoclave	Cat 4, 7	Printer working
Medical College & Hospital	Kolkata	1718	61820.097	Microwave	Cat 4, 7	Printer Not Functioning
Arovinda Seva Kendra	Kolkata	100	6132.000	Autoclave	Cat 4, 7	Printer working
NICED	Kolkata	x	80.000	Incinerator	Cat 2	No printer
Grand Total			453492.409			

Total Amount of BMW Treatment in the State:

Type of Facility	Amount of BMW Treatment in Kg	%	Source
CBWTF	2876428	86	Report submitted to WBPCB
Stand-Alone	453492	14	Derived as per table above
Total	3329920		

Region-wise BMW Treatment in West Bengal					
Region	Districts	BMW Treated in 2009 in large private CBWTF in Kg	BMW Treated in 2009 in small govt. CBWTF in Kg	BMW Treatment in Stand-alone facilities in Kg	Total BMW Treated in Kg
South-West Region	East Midnapore	37171		6132	43303
	West Midnapore				
South Region	Kolkata	1791613		68032	1891751
	Howrah			17706	
	South 24 Parganas		14400		
Central Region	Murshidabad	724425		32998	903565
	Nadia		2856	75532	
	North 24 Parganas			16274	
	Hooghly			51480	
West Region	Bankura	190888			291834
	Burdwan			58749	
	Birbhum			42197	
	Purulia				
North Region	Coochbihar	115075		33757	199468
	Jalpaiguri				
	Darjeeling				
	Uttar Dinajpur				
	Dakshin Dinajpur				
	Malda			50636	
Grand Total		2859172	17256	453492	3329920

As the operational areas of the important large CBWTFs include more than one number of districts, there is no scope of calculating amount of district-wise treatment of BMW treatment. However region-wise amount of treatment derived from the data of both common and stand-alone facilities tabled above.

Region-wise Account of BMW Treatment in relation to generation :

Region-wise BMW Generation and Treatment in West Bengal in 2009																																																									
Region	Districts	BMW Generated in District in Kg	Total BMW Generated in Region in Kg	Total BMW Treated in Region in Kg	% of BMW Treated																																																				
South-West Region	East Midnapore	329081	859336	43303	5																																																				
	West Midnapore	530255				South Region	Kolkata	3490058	4547845	1891751	42	Howrah	571293	S. 24 Parganas	486494	Central Region	Murshidabad	454249	3115088	903565	29	Nadia	646086	N. 24 Parganas	1201879	Hooghly	812874	West Region	Bankura	400763	2046127	291834	14	Burdwan	1117369	Birbhum	261981	Purulia	266014	North Region	Coochbihar	214719	1431507	199468	14	Jalpaiguri	297754	Darjeeling	525606	Uttar Dinajpur	105332	Dakshin Dinajpur	92354	Malda	195742	Grand Total	
South Region	Kolkata	3490058	4547845	1891751	42																																																				
	Howrah	571293																																																							
	S. 24 Parganas	486494																																																							
Central Region	Murshidabad	454249	3115088	903565	29																																																				
	Nadia	646086																																																							
	N. 24 Parganas	1201879																																																							
	Hooghly	812874																																																							
West Region	Bankura	400763	2046127	291834	14																																																				
	Burdwan	1117369																																																							
	Birbhum	261981																																																							
	Purulia	266014																																																							
North Region	Coochbihar	214719	1431507	199468	14																																																				
	Jalpaiguri	297754																																																							
	Darjeeling	525606																																																							
	Uttar Dinajpur	105332																																																							
	Dakshin Dinajpur	92354																																																							
	Malda	195742																																																							
Grand Total		11999902	11999902	3329921	28																																																				

Thus as a whole 28% of BMW generated in the bedded, non-bedded HCUs and pathological laboratories is being treated. If we consider all the BMW generation, the proportion of treatment will definitely be lower. It is to be noted that maximum proportion (42%) of BMW treatment is taking place in South Region (Kolkata,

Howrah and South 24 Parganas) whereas lowest proportion (5%) of treatment is taking place in the adjacent South-West region (West and East Midnapore). The following chart shows the situation at a glance:

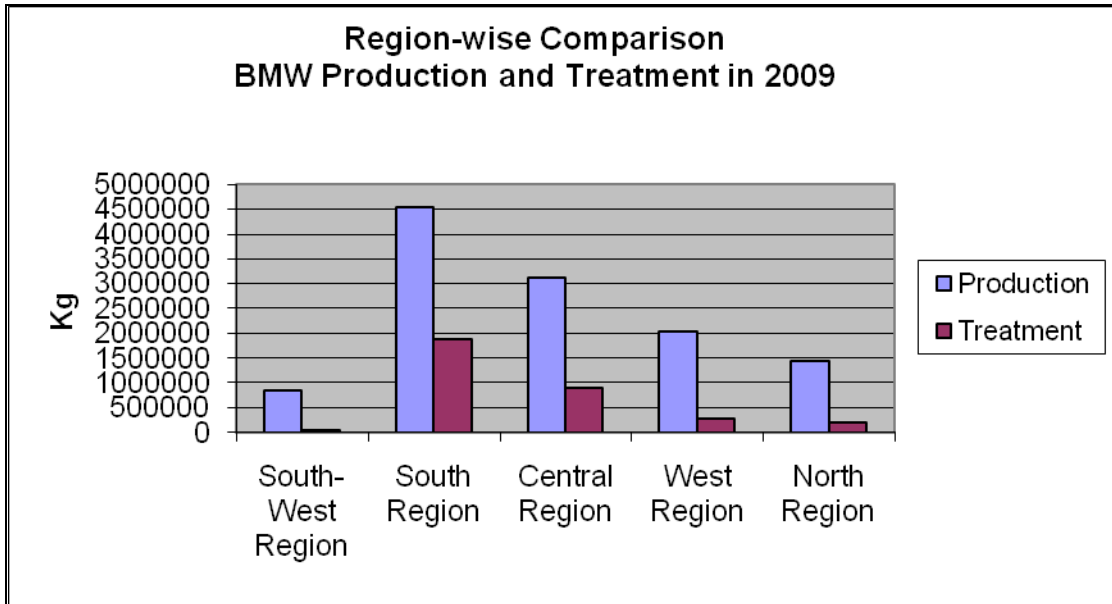

Comparison between BMW generation and treatment capacity available in the state :

Considering region-wise present generation and existing capacity of treatment available in the state the following can be derived :

BMW Generation and Treatment Capacity			
Region	Generation in Kg	Capacity in Kg	% Capacity w.r.t Generation
South-West Region	859336	1831132	213
South Region	4547845	2841123	62
Central Region	3115088	2987149	96
West Region	2046127	2838446	139
North Region	1431507	1453143	102
	11999903	11944861	100

It is very interesting to note that as a whole BMW treatment capacity available in the state is 100% of its present generation. But that does not indicate that the capacity is

enough in all the regions. In South region already capacity falls much short of production, in Central Region falls short, in North region almost saturated whereas it is largely excess in West and South-West regions.

We may have a detailed account of the capacity with reference to present generation :

Region-wise BMW Generation and Treatment Capacity in West Bengal						
Region	Districts	BMW Generation in Kg in 2009	BMW Treatment Capacity of Large CBWTFs in Kg*	BMW Treatment Capacity of Small CBWTFs in Kg*	BMW Treatment Capacity in Stand-alone facilities in Kg**	Total BMW Treatment Capacity in Kg
South-West Region	East Midnapore	859336	1825000		6132	1831132
	West Midnapore					
South Region	Kolkata	4547845	2737500	17885	68032	2841123
	Howrah				17706	
	S. 24 Parganas					
Central Region	Murshidabad	3115088	2737500	73365	32998	2987149
	Nadia				75532	
	N. 24 Parganas				16274	
	Hooghly				51480	
West Region	Bankura	2046127	2737500			2838446
	Burdwan				58749	
	Birbhum				42197	
	Purulia					
North Region	Coochbihar	1431507	1368750		33757	1453143
	Jalpaiguri					
	Darjeeling					
	Uttar Dinajpur					
	Dakshin Dinajpur					
	Malda				50636	
* In case of CBWTFs capacity in Kg has been derived by multiplying their Capacity by Bed with average .250 Kg per bed in a year						
** In case of Stand Alone Facilities capacity has been derived by multiplying the respective HCUs' Bed strength with average generation per bed per day in that category in a year						

Requirement of more CBWTF in West Bengal:

Determination of requirement of more CBWTF should be based upon projected generation of next few years and not today’s generation. Projected generation of BMW up to 2020 has already shown in *Summary Quantification* chapter. On the basis of that the following comparison may be seen at a glance in the following table and chart -

BMW Generation in 2020 and Treatment Capacity in 2009			
Region	Projected Generation in 2020 in Kg	Capacity in 2009 in Kg	% Capacity w.r.t Generation
South-West Region	958734	1831132	191
South Region	5073887	2841123	56
Central Region	3475405	2987149	86
West Region	2282799	2838446	124
North Region	1597087	1453143	91

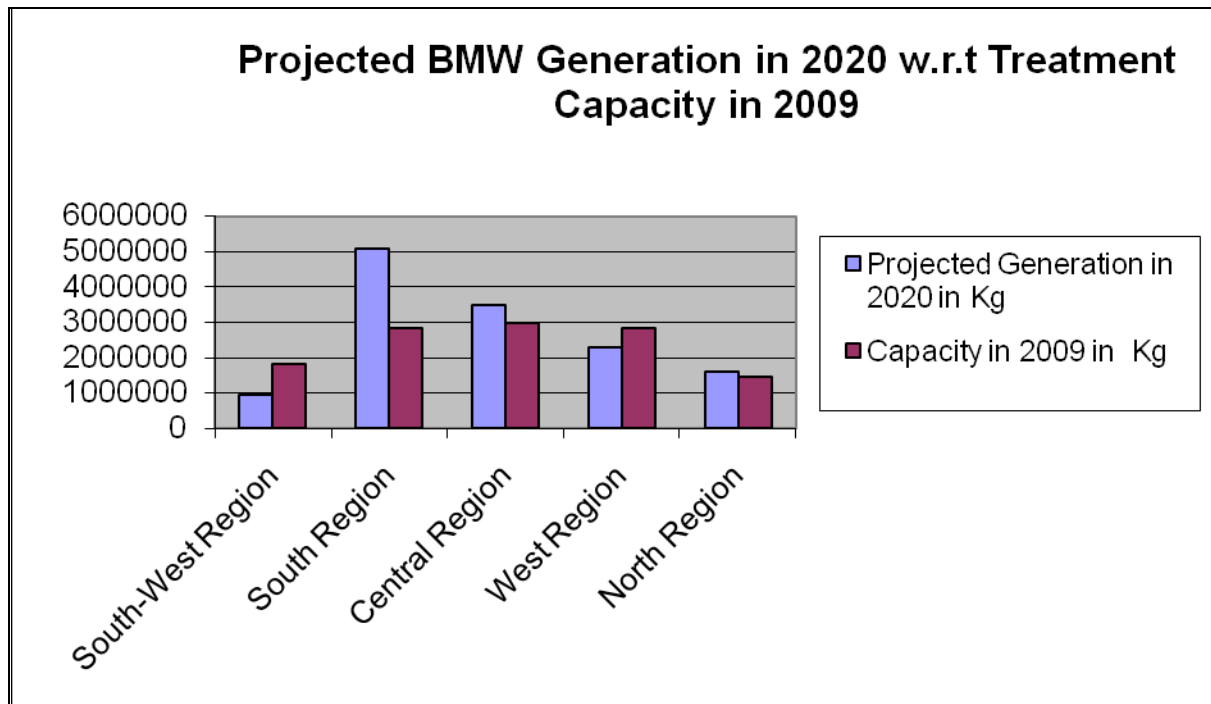

Thus it may be concluded that following three regions need more facilities:

Requirement of More Treatment Facility				
Region	No. of Treatment Facility Required	Capacity by bed	Capacity by weight in Kg	Suggested Location
South Region	1	30000	2737500	South 24 Parganas
Central Region	1	15000	1368750	Hoogly
North Region	1	15000	1368750	Malda or Dakshin Dinajpur

Simultaneously massive drive needs to be taken for the HCUs in South East region and West region so that the HCUs which have not yet initiated BMW management to bring under coverage of the respective CBWTF.

Issue of treatment of Recyclables and Non-recyclables in CBWTF:

The issue is often raised that a good amount of recyclables are being directly salvaged from the HCUs and is not arriving to the treatment facilities. An effort is made to check data received from treatment facilities whether that corroborates the apprehension.

During the study it is observed that recording system of SembRamky plants are more dependable. So the data of 2009 from only 3 SembRamky facilities in Howrah, Burdwan and Kalyani is being examined:

Proportion of Non-Recyclables and Recyclables Treatment in CBWTF				
Facility	Non-Recyclable		Recyclable	
	Amount in Kg	%	Amount in Kg	%
SembRamky, Howrah	1561423	87	230190	13
SembRamky, Kalyani	686914	95	37511	5
SembRamky, Burdwan	164879	86	26009	14

The data clearly reveals that when proportion of recyclable in BMW generated as a whole is 45% and particularly in case of bedded HCUs 40%, the proportion comes for treatment falls much short.

This indicates two possible irregularities :

1. Rampant salvaging in the HCUs from where untreated recyclables are directly going in the hands of recycling traders. Unbroken syringes are repacked and sold in the market posing great risk of public health. Other recyclables may be going in the recycling units where those are processed but during handling of such materials carriers and workers face great risk of infection.
2. Some of the recyclables due to erroneous segregation in the HCUs are going into yellow bags meant for Cat 1, 2, 3, 5 and 6. Subsequently these are incinerated. As major portion of these recyclables (Cat 4 and 7) are made of plastic, especially PVC, incineration of these materials may produce dioxin and other toxic contaminants posing enormous health risk of public. Study should be conducted to probe whether a secondary segregation may be conducted at the CBWTFs to avoid incineration of such recyclables. Of course process of such secondary segregation must confirm environmental and occupational safety of the workers.

Issue of Incineration Ash of CBWTFs

Ash generated in incinerators may be toxic and as per Rules the same is to be disposed of in a hazardous landfill. All the CBWTFs in West Bengal have reported that they send incineration ash to hazardous landfill in Haldia.

**OPTIONS BEYOND
REACH OF CBWTFs**

There are many health care units (HCUs), especially small ones, for which connecting to CBWTFs may not be expedient for following reasons :

- i) Remoteness of the place may make it difficult for CBWTF vehicles reach the HCU at least once in every 48 hours (as per BMW Rules, no untreated bio-medical waste may be kept stored beyond a period of 48 hours).
- ii) Smallness of the quantity of BMW generated may not justify plying of CBWTF vehicles to collect BMW in regular manner.

The problem may be discussed in detail.

In rural setting there are many areas in different districts which are sparsely populated. Distribution of HCUs like Rural Hospital (RH), Block Primary Health Centres (BPHC) and Primary Health Centres (PHC) in these areas are few and far between in comparison to those in other areas. Again there are many HCUs in remote areas like hills and Sundarbans where CBWTF vehicles cannot reach in proper frequency.

Particularly in case of West Bengal, at present, one CBWTF, that is Greenzen Bio Pvt. Ltd. has been designated to cover entire North Bengal comprising of 6 districts – Coochbihar, Jalpaiguri, Darjeeling, Uttar Dinajpur, South Dinajpur and Malda. It seems very difficult in the present set up to touch all the HCUs of this vast area in a regular interval of 48 hours.

In case of government Sub Centres and Outreach Sessions in rural areas it is a common problem. These HCUs individually produce very small amount of BMW. Another feature of these HCUs is that these do not remain open for long time. Though the amount of BMW generated by these individual units is not very much but number of these HCUs is very high and total amount of BMW produced by these HCUs is significant. (It is shown in the Chapter – Present Status of Treatment and Disposal that such non-bedded HCUs contribute 17% of total BMW generated in the state.) Also, the waste generated by these units is mostly bio-medical (80%) a major portion of which is sharp waste. As such those deserve proper handling, treatment and disposal.

In municipal areas too there are some stand alone Extended Special Out Patient Departments (ESOPDs) and many Sub Centres which individually generate very little amount of BMW but total amount of BMW generated by these units as a whole is significant. These units individually generate very small amount of waste. Moreover, they do not remain open for a long time. So collection of waste from these facilities through CBWTF vehicles may not be very convenient.

Many health camps and blood donation camps are conducted in cities, towns and villages. Their places and timings are not fixed. But they produce considerable

amount of BMW of the same nature as in SCs, municipal SCs and ESOPDs. For implementation of BMW management at these levels, appropriate strategy is to be taken and plan of action has to be prepared in accordance with such strategy.

Strategy 1 : Develop in-house treatment and disposal facility in RH, BPHC or PHC levels as and where required.

Strategy 2 : Arrange easy transportation of BMW from government Sub Centres, Outreach Sessions, municipal Sub Centres, ESOPDs, health camps and blood donation camps in properly segregated manner and treatment (as and where required) to the nearest location of treatment facility or nearest station for handing over to CBWTF vehicles.

Strategy 1: Developing In-house Treatment and Disposal Facilities for RH/BPHC/PHC

Options for Collection, Treatment and Disposal in RH/BPHC/PHC
SUGGESTED FLOW CHART FOR BMW MANAGEMENT
AT RH/BPHC/PHC LEVEL BEYOND REACH OF CBWTF

WASTE CATEGORY		OPTIONS		
Bio-Medical		I	II	III
Sharps (cat 4)	Syringe & Needle	Defang >> Put Needles in chemical disinfectant	Campus Pit (Deep Burial)	
	Broken Ampoule /glass	Put Broken Ampoules/glass in chemical disinfectant with Needles		
Soiled (cat 6)	Dressings, Bandage, Linen etc.	Collect separately	Steam Sterilization	Trenching for Biodegradation
Solid (cat 7)	Plastic Tubings/Bags; Cut Syringes; Glass, Bottles	Collect Separately	Steam Sterilization	Recycling
Anatomical (cat 1, 3,5)	Placenta, Tissue etc., Laboratory, Discarded Medicines	Collect Separately	Campus Pit (Deep Burial)	

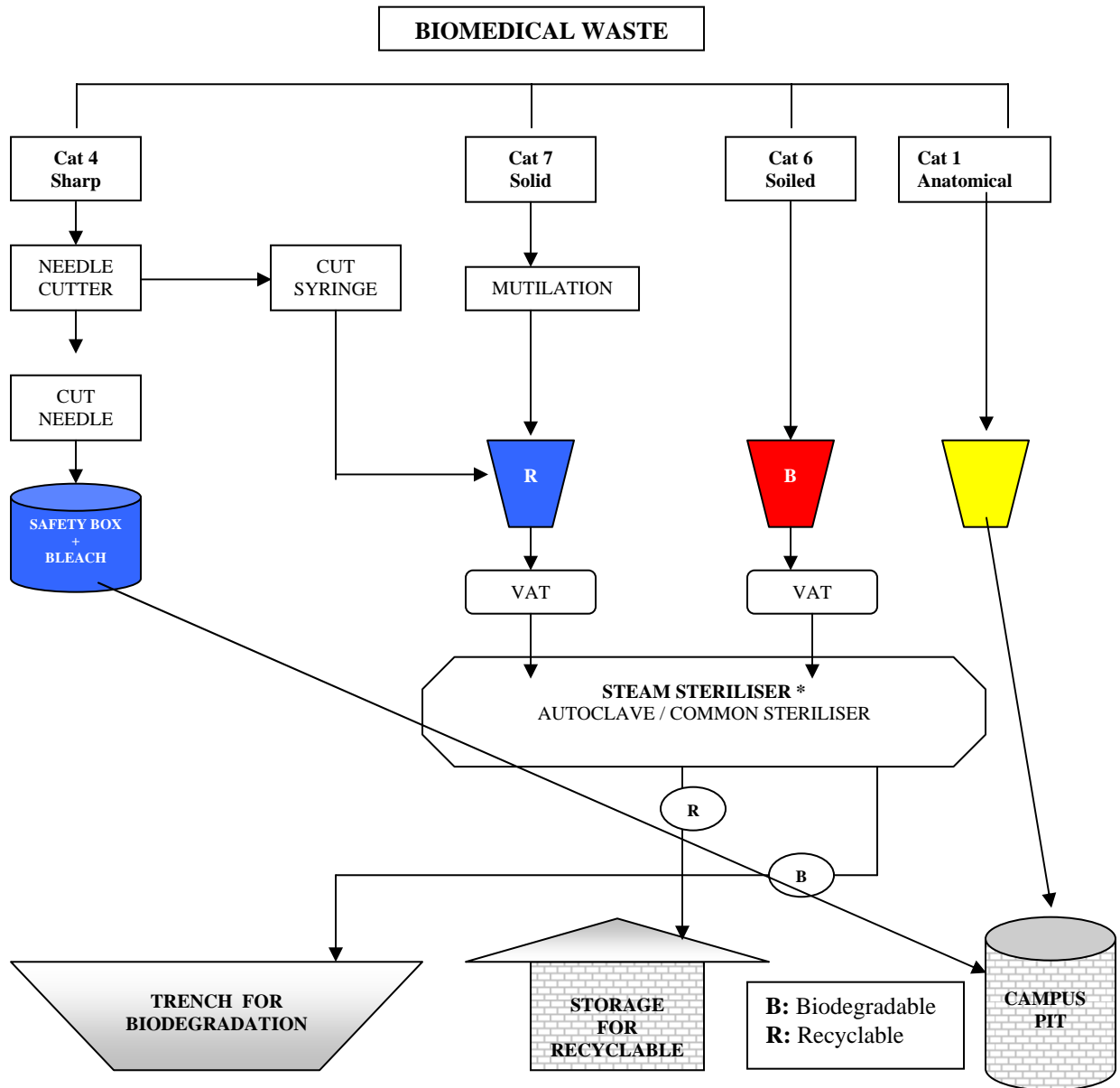

Facilities Required:

- a) **Steam Sterilizer :** If fully equipped waste autoclave is not available a low cost autoclave or common steam sterilizer may be used to treat Cat-6 and Cat-7 BMW. According to BMW Rules medical waste cannot be considered as properly treated unless the time, temperature and pressure parameters are maintained to the prescribed degree during the autoclave process. However, where Autoclave with recording facility is not available, common Steam Sterilizers may be used for treatment of infectious waste as a transitional measure. CPCB "Guidelines for Disposal of Bio-medical Waste Generated during Universal Immunization Programme (2004)" even suggests boiling in water where autoclaving is not

available. A chemical indicator strip/tape that changes colour when a certain temperature is reached can be used for verification of temperature. But this would require approval of State Pollution Control Board.



Autoclave



Common Steam Sterilizer

b) **Burial Pit** : All the RHs, BPHCs and PHCs have space in their compounds. Burial pits have to be constructed at secluded places in the compounds. These may be called Campus Pits and shall be used exclusively to dispose sharp and anatomical waste.

Every RH is supposed to already have Campus Pits built under “West Bengal Health Systems Development Project (WBHSDP)”. But most of them have now been filled up. Requirement of new construction needs to be assessed.



Campus Pit

New Campus pits as and where required may be designed as in the following -

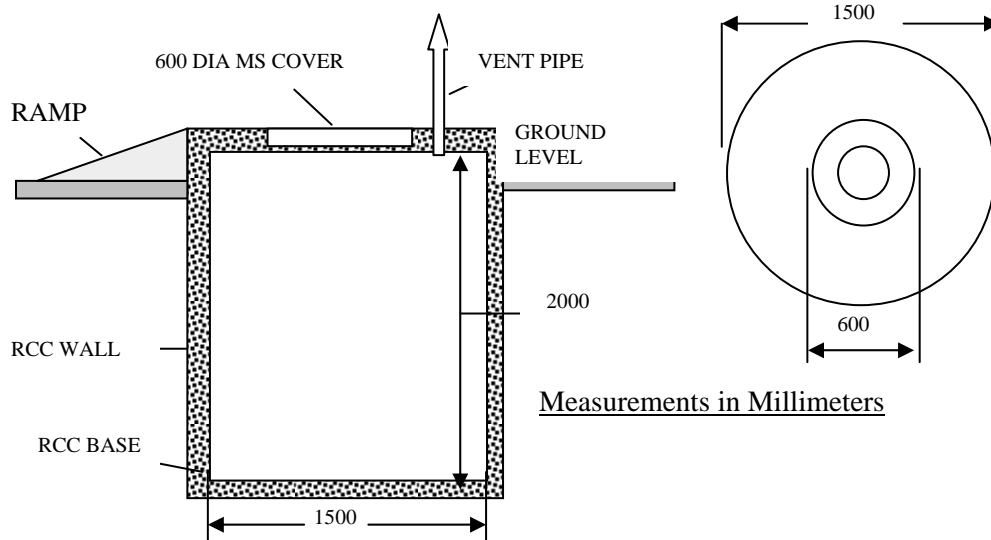

c) **Trench** : Trenches are required for systematic bio-degradation of decontaminated waste. A system of trenches secured with fencing and shade is the suggested option. The trenches are to be used on rotational basis.

d) **Vats for infected biodegradable and recyclable waste** : Separate vats for biodegradable and recyclable waste are necessary for temporary storage of waste before treatment. They should be well protected to debar scavengers and foraging animals, with easy approach and located near the place for waste treatment and away from the place of medical treatment. There should be arrangement for regular supply of water for washing.

e) **Store for general and decontaminated recyclables waste** : Storage Facility is necessary for temporary storage of treated recyclable waste and general recyclable waste before sending those for recycling.

Strategy 2 : Arrangement of on-site chemical treatment at SCs, ORSs, ESOPDs, Health Camps and easy transportation to the nearest location of treatment facility or nearest station for handing over to CBWTF vehicles.

Some salient points regarding these HCUs are to be kept in consideration:

1. These HCUs generally do not function daily. With some exceptions the common feature is as follows :

Government Sub Centres	2 days in a week
Government Out Reach Sessions*	1 day in a week
Municipal Sub Centres	2 days in a week
Municipal ESOPDs	2 - 5 days in a week
Health Camps, Blood Donation Camps	No specific time and place

* (Out-Reach Sessions generally do not have any fixed area or site. These are held in remote areas and are conducted by concerned Sub-Centres)

2. These HCUs function for limited period, 3 - 6 hours.
3. These HCUs produce only Cat 4 (syringe, needle, broken ampoules), Cat 6 (cotton swabs) and 7 (plastic vials, glass vials).
4. Proportion by weight of Cat 4 and 7 is almost 90 - 95% whereas Cat 6, (mainly cotton swab) is 5 - 10% by weight.

To implement BMW management in these HCUs, waste has to be segregated at the point of generation as suggested in the following flow-chart. It is suggested that the BMW generated on the functioning days in these HCUs should be carried back to the Vaccine Distribution Centres where either a treatment facility is available or CBWTF vehicles visit regularly. A tool kit specially designed for this purpose may be used to carry the waste in segregated manner. The vaccine carrier, who carries the vaccines back from these HCUs to the VDCs, after the day's work, may also carry this kit bag.

OPTIONS FOR - COLLECTION, TREATMENT, DISPOSAL
at GOVT. SC, ORS, MUNICIPAL SC, ESOPD AND HEALTH CAMPS

WASTE CATEGORY	OPTIONS → →		
	I	II	III
Syringe & Needle (Cat 4)	Defang >> Put Needles in safety box with chemical disinfectant Put Syringes in container with chemical disinfectant	Keep chemically treated - 1. Needles & Ampoules in safety box 2. Syringes, Vials & Bottles in container	1. Dispose Needles & Ampoules from safety box in sharp pit at Govt. Sub-Centre (if available) / OR at nearest treatment and disposal facility OR at nearest station for handing over to CBWTF vehicles 2. Send Syringes, Vials & Bottles to nearest treatment and disposal facility OR at nearest station for handing over to CBWTF vehicles
Broken Ampoule (Cat 4)	Put Broken Ampoules in safety box with chemical disinfectant		
Used Vaccine Vial (Cat 7)	Put Vaccine Vials in container with chemical disinfectant		
Cotton Swabs (Cat 6)	Put Cotton Swabs separately in container lid with chemical disinfectant	Keep chemically treated	Put in sharp pit at Govt. SC (if available) OR to nearest treatment and disposal facility OR at nearest station for handing over to CBWTF vehicles

FLOW CHART FOR WASTE MANAGEMENT
For GOVT SC, ORS, MUNICIPAL SC, ESOPD AND HEALTH
CAMPS

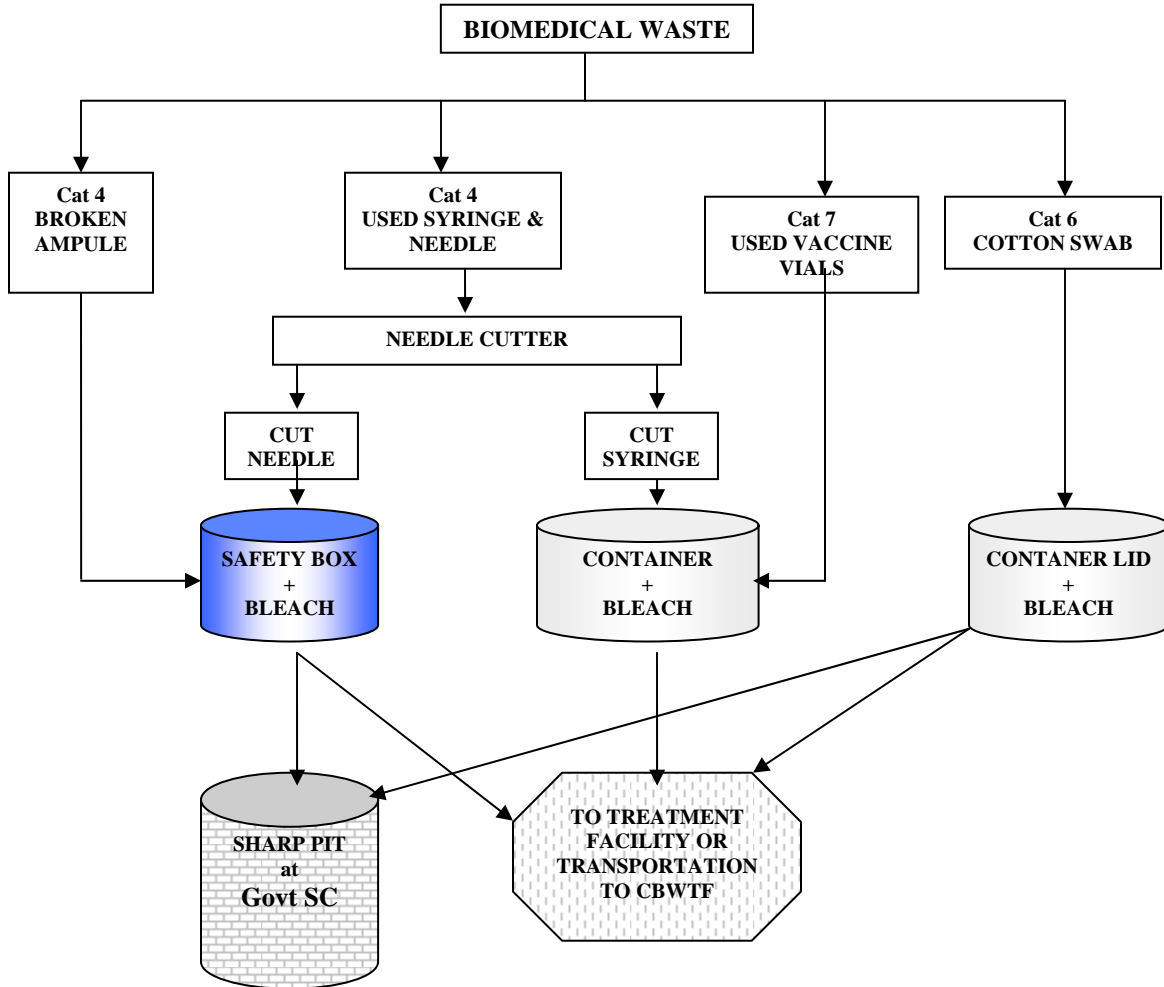

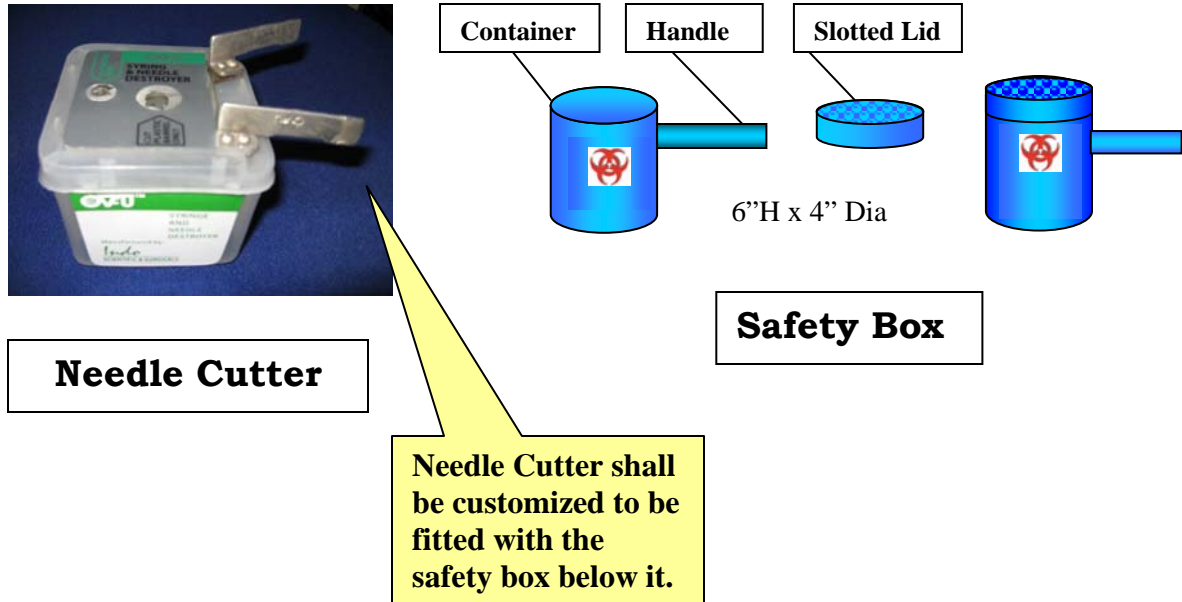
Facilities Required:**a) Needle Cutter with Safety Box for sharps:**

Needle Cutter : Most of the BMW generated in these HCUs is from injection. Hence keeping a needle cutter is very important. The cutter should be able to cut the syringe at the hub of the needle. While cut needles may be disposed of in sharp pits, cut syringe may be ultimately sent for recycling.

Safety Box

Safety Box with biohazard symbol is required to collect and treat waste sharps right after generation.

The **Safety Box** shall be attached below the needle cutter to collect the cut needles. This detachable container may be used to decontaminate the cut needles with chemical decontaminant (1% Bleach Solution).

Broken ampoules may also be collected and treated in the same container. These decontaminated sharps may be finally disposed in a sharp or campus pit.

This container may have a slotted lid to help drain out the spent bleach solution after decontamination of sharp waste.

Suggested Material: Unbreakable translucent plastic.

b) Container for other BMW:

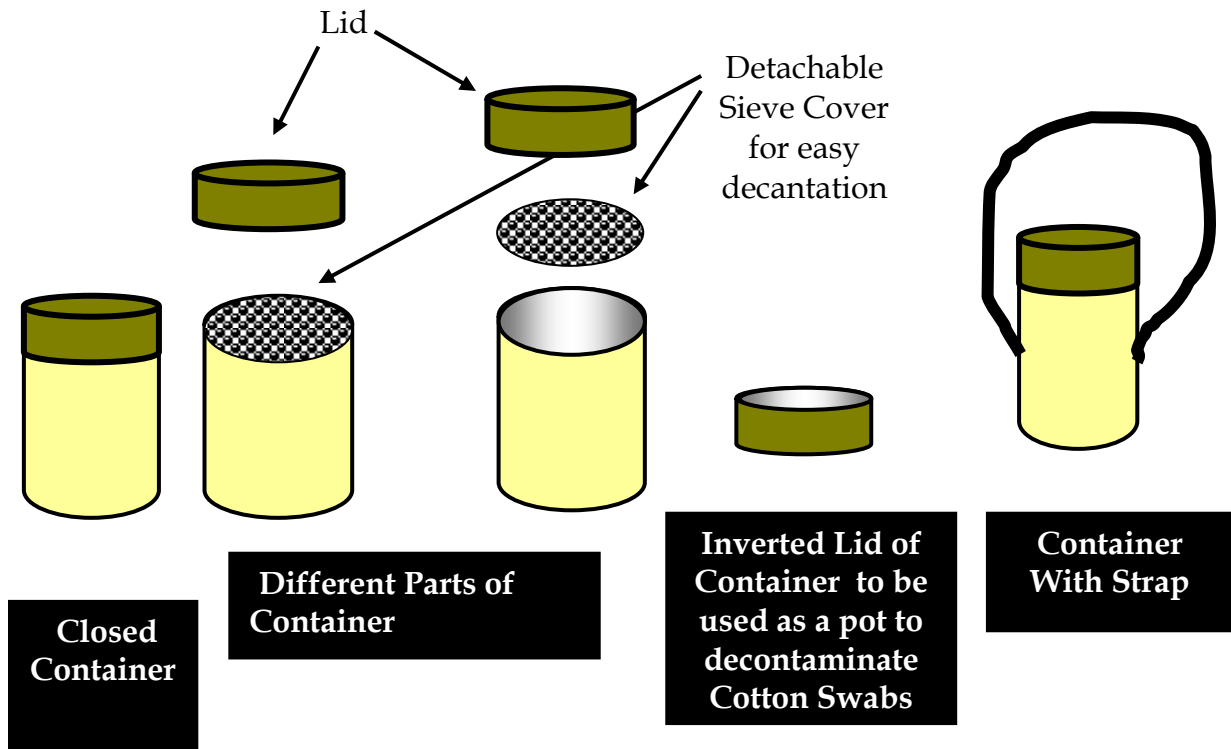

The Container is to serve multiple purposes.

The body of the cylindrical box may be used as a pot to decontaminate cut syringes and used vaccine vials by filling it with decontaminating solution and dipping the cut syringes and used vials into it.

The lid, when inverted, may be used as another pot to decontaminate cotton swabs by filling it with decontaminating solution and dipping the cotton swabs into it.

After decontamination the hypo-chlorite/bleach solution shall be drained out. A detachable sieve cover that fits in between the lid and the body of the safety box helps in pouring out the used decontaminant.

Cut syringes and used vaccine vials as well as the cotton swabs, after decontamination can be kept separately in the safety box and carried.

Suggested Material : Unbreakable Plastic.

c) Tool Kit for carrying segregated waste:

Decontaminated cut syringes and used vials together with cotton swabs may be carried back in the Safety Box from point of generation to nearest location of disposal/treatment/CBWTF vehicles.

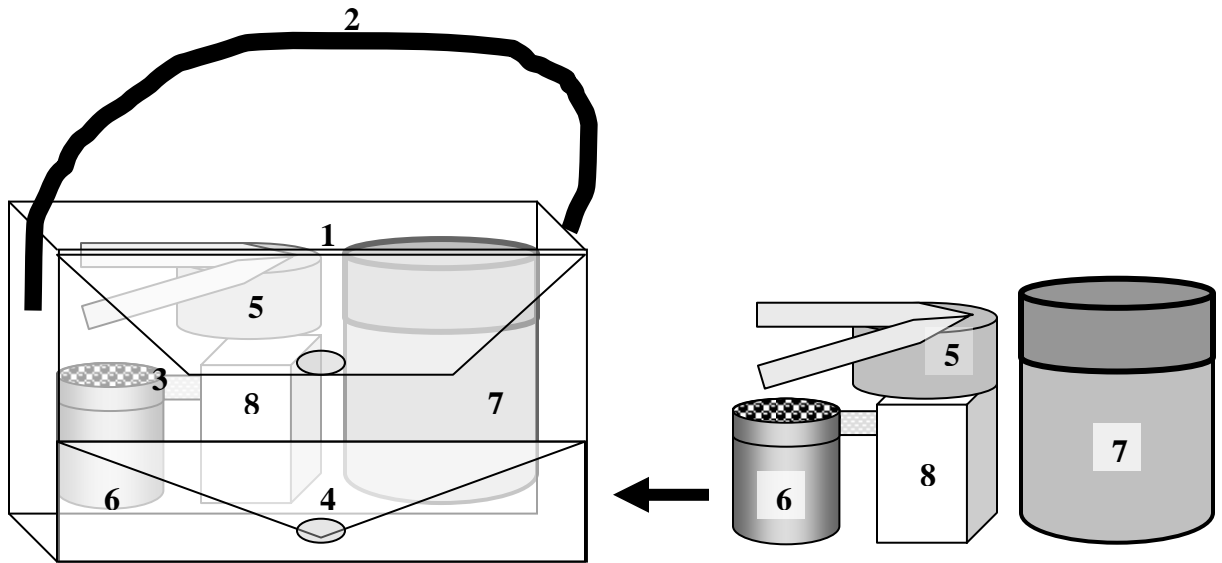

1. **TOOL KIT** - To hold and carry all tools and BMW for & from ORS
2. **STRAP** - Attached to TOOL KIT
3. **MAIN CHAMBER** - Of the TOOL KIT
4. **POUCH POCKET** - To hold and carry the general (packaging) waste from ORS
5. **NEEDLE CUTTER** - To defang syringes
6. **SAFETY BOX** - To disinfect, hold and carry cut needles
7. **CONTAINER** -To hold, disinfect and carry cut syringes, used vials and soiled cotton swabs
8. **BLEACHING POWDER PACK** - To provide bleaching powder for prepare bleach solution.

d) Sharp Pit at government Sub Centres for disposal of needles and swabs :

Many of the government Sub Centres are located at government premises. Low cost sharp pits may be constructed at these Sub Centres where needles and cotton swabs may be disposed. If such advantage is not available, the same with other BMW will be transported to nearest location of treatment facility or nearest station for handing over to CBWTF vehicles.

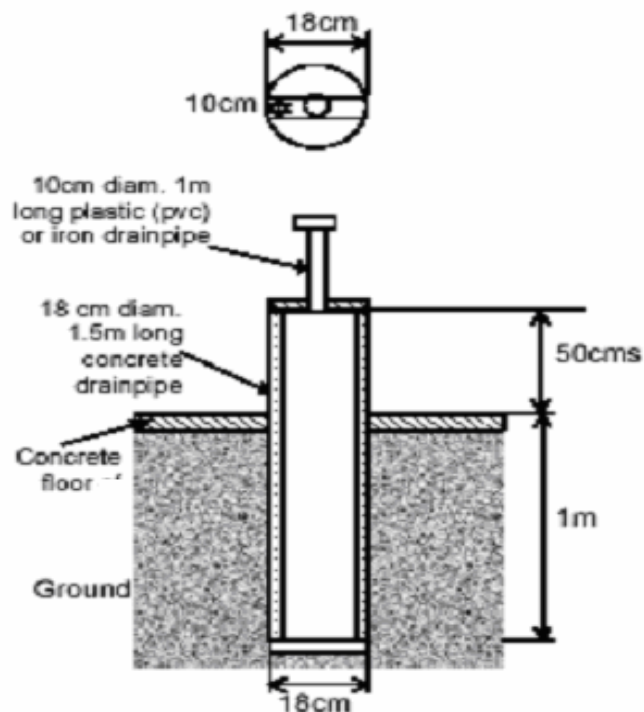

A sharp pit may be constructed by utilizing simple concrete drainpipe as shown in the figure. Caps to have locking facility

Highlights of the system :

The BMWM strategy presented above for HCUs beyond reach of CBWTFs has been developed with the objective to help establish a system that -

- A. Complies to existing rules and guidelines
- B. Is economic to run
- C. Is simple to adopt
- D. Utilises existing waste management facilities
- E. Utilises existing vaccine delivery route
- F. Maximise resource recovery
- G. Minimise use of plastic bags i.e., minimise waste generated in the process of waste management

**PRESENT STATUS
OF IN-HOUSE
BMW MANAGEMENT**

Survey in some selected HCUs of different categories with a view to develop an assessment of the compliance status.

List of HCUs

Survey on BMW management practices was conducted in the following HCUs with bed strengths and treatment / disposal facilities as mentioned in the table:

List of HCUs under Assessment				
Category	Name of HCUs	Bed Strength	Status up to Sept 2009	
			Connected to CBWTF	Having Stand Alone Facility
MCH	Bankura Sammilani Medical College & Hospital	1217	×	×
	Burdwan Medical College & Hospital	1099	√	√
	North Bengal Medical College & Hospital	1000	×	×
	Medical College & Hospital, Kolkata	1718	√	√
	R.G. Kar Medical College & Hospital	1107	√	
	S.S.K.M. Medical College & Hospital	1650	√	
	Calcutta National Medical College & Hospital	1260	√	
	Nilratan Sarkar Medical College & Hospital	1890	√	
DH	Siuri Sadar Hospital, Birbhum	500		√
	M.J.N. Hospital - Coochbehar	400		√
	Dist. Hospital Dakshin Dinajpur - Balurghat	300	×	×
	District Hospital - Darjeeling	308	×	×
	Siliguri District Hospital, Darjeeling	320	×	×
	Purba Medinipore Dist. Hospital, Tamluk	336	×	×
	Imambara Sadar Hospital, Hooghly	540		√
	Howrah District Hospital	544	√	√
	Sadar Hospital - Jalpaiguri	610	×	×
	M.R. Bangur Hospital, South 24 Pgs	600	√	
	District Hospital -Malda	600		√
	District Hospital - Murshidabad	391		√
	District Hospital - Nadia (Sadar Wing)	495		√
	District Hospital - Nadia (Shaktinagar Wing)	400		√
	District Hospital - Barasat, North 24 Pgs	500	√	√
Deben Mahato Hospital, Purulia	500	√		
Raiganj Dist. Hospital, Uttar Dinajpur	168	×	×	

Category	Name of HCUs	Bed Strength	Status up to Sept 2009	
			Connected to CBWTF	Having Stand Alone Facility
SDH	S.D. Hospital - MAL, Jalpaiguri	100	×	×
	S.D. Hospital - Bishnupur, Bankura	230	×	×
	Diamond Harbour SDH, South 24 Pgs	125	√	
SGH	Birpara State General Hospital, Jalpaiguri	100	×	×
	Vidyasagar State General Hospital, Kiolkata	256	√	
	Jawaharlal Nehru Memorial Hospital, Nadia	550	√	
RH	Taldangra Rural Hospital, Bankura	30	×	×
	Kharibari Rural Hospital, Darjeeling	30	×	×
BPHC	Anchuri BPHC, Bankura	10	×	×
	Matigara BPHC, Darjeeling	10	×	×
PHC	Bagdogra PHC, Darjeeling	10	×	×
	Panchmura PHC, Bankura	6	×	×
Sub Centre	Anchuri Sub Centre, Bankura	*	×	×
	Kharibari Sub Centre, Darjeeling	*	×	×
Muni Hospital	Dum Dum Municipality Hospital, N 24 Pgs	110	×	×
	Muni Hospital, Vivekananda Palli, Malda	18	×	×
Muni Matri Sadan	Balurghat Municipal Hospital and Matri Sadan, South Dinajpur	30	×	×
	Titagarh Maternity Home, North 24 Pgs	12	×	×
Private Hospital	AMRI, Kolkata	380	√	
	Woodlands, Kolkata	245	√	
	Institute of Child Health, Kolkata	116	√	
	Dr. M N C Nursing Home, Coochbehar	10	×	×
Specialty Hospital	Chitta Ranjan National Cancer Institute, Kolkata	200	√	
	BD & IG Hospital, Kolkata	780	√	
	K. S. Roy TB Hospital, Kolkata	350	√	
	Premananda Memorial Leprosy Hospital, Kolkata	70	√	
	DISHA Eye Hospital & Research Centre, North 24 Pgs	115	√	
	R. Ahmed Dental College & Hospital, Kolkata	100	√	
	Institute of Animal Health, Kolkata	*	×	×
	National Institute for Cholera & Enteric Diseases	*	√	√

* Non-bedded HCUs

Methodology of Assessment of Status :

The study was conducted through survey of existing BMW management practices in the above mentioned HCUs raising the following questions :

1. Whether the HCU has **agreement with CBWTF** or has **stand-alone facility**?
2. Whether there is any **BMW management task force** and designated **Waste Management In-charge**?
3. Whether the health workers are **aware, motivated and trained**?
4. Whether **sharp management instruments** are available and whether **sharp management** is performed properly?
5. Whether **mutilation equipments** are available and **mutilation** is done in proper manner?
6. Whether **bins and bags** are **available** and **placed at proper places**?
7. Whether **segregation at source** is done in proper manner?
8. Whether **temporary in-house storage facilities** for BMW are available?
9. Whether BMW bags are properly **carried and transferred** to storage / stand-alone facilities?
10. Whether BMW are properly **transferred or handed over** to the **CBWTFs**?
11. Whether any portion of BMW is **salvaged** or **pilfered**?
12. Whether **personal protective equipments (PPE)** are available and used by the health and BMW management workers?

Observations

An overall understanding on the basis of observations on the above points is being presented here in a nutshell:

1. Whether the HCU has **agreement with CBWTF** or has **stand-alone facility**?

During survey it was observed that most of the MCHs and District Hospitals either had agreement with CBWTFs or had their own stand-alone treatment facilities. But 3 MCHs (Bankura, Midnapore and North Bengal) and 6 District Hospitals (Darjeeling, Siliguri, Jalpaiguri, Raiganj, Balurghat, Tamluk) did neither have agreement with CBWTF nor any stand-alone facility.

In Kolkata and Howrah region most of the HCUs, both government and private, have agreement with CBWTFs. In North 24 Parganas, Nadia, Hoogly and Bardhaman a good number of HCUs have come under such agreement. In case of Bankura, Purulia, Birbhum, East and West Midnapore and in districts of North Bengal situation is poor. Most of the HCUs in these regions neither have any agreement with CBWTF nor have their own stand-alone facility.

None of the municipality hospitals has any agreement with CBWTF. Though **Dum Dum Municipal Specialised Hospital** is situated in Kolkata, unlike most of the important hospitals in Kolkata, it has not connected itself with CBWTF. All Bio-medical waste of this hospital is disposed of at Noapara dump site. Municipal hospitals and maternity homes dispose of their waste in municipal dump sites. In some municipalities transportation is performed by transports dedicated for carrying BMW.

It can be inferred that infrastructure for BMW management in the state has fairly developed and can meet most of the requirements but a large number of HCUs are yet to come under the regime of BMW management. The condition is somewhat better in several regions like Kolkata, Howrah, North 24 Parganas, Nadia, Hoogly and Burdwan.

2. Whether there is any BMW management **task force** and designated **Waste Management In-charge**?

None of the HCUs in list has any task force to regularly monitor in-house BMW management. No regular periodic review takes place for assessment and improvement of the situation. During implementation of State Health Development Project (WBSHDP) formation of task force on BMW management was compulsory in the government HCUs. But in the last few years after the project the task forces disappeared. However a body called Rogi Kalyan Samiti (Patients' Welfare Committee) has been introduced. This is a body constituted in the government hospitals as an innovative mechanism to involve the people's representatives in the management of the hospital with a view to improve its functioning. One of its terms of reference is to ensure adequate and safe disposal of hospital wastes. But apart from purchasing of bags, bins and equipments, the improvement of quality of BMW management is seldom brought in its agenda. Usually there are no trained personnel on BMW management in such Samitis. In case of private HCUs, BMW management depends upon their general work culture. Any committee or monitoring body exclusively for periodic review of BMW management and improvement does not generally exist.

Usually all the HCUs have one or more designated official/s to look after BMW management. Heads of the HCUs are generally responsible for conduction of BMW management. In case of large government hospitals Assistant Superintendents also have such responsibilities. But they usually are bogged with so many responsibilities that seldom they can monitor day-to-day management of BMW. So the responsibility of day-to-day monitoring lies with one of the ward masters in government HCUs and house-keeping staff in case of private HCUs. These people generally do not have any training on BMW management. Moreover they also have to perform many

other responsibilities and remain hard pressed. Therefore, none of the HCUs has any exclusively responsible trained person for effective monitoring of in-house waste management. In some HCUs due to individual initiative (eg., Superintendent, Imambara Sadar Hospital, Hoogly and Matron, Institute of Child Health) quality of waste management is much better. But that is not the case in general. The absence of an exclusively responsible person is a common deficiency detrimental to the quality of waste management.

Issue of cost involved in waste management in relation to designation of exclusive responsibility is also important. For example, if government HCU with 500 bed occupancy is attached with a CBWTF, it has to pay the CBWTF owner around Rs. 2500 per day or around Rs. 75000 per month. In case of private HCUs it is more. If the in-house waste management is not performed in proper manner, keeping in relation to the CBWTF system, the money gets wasted. In the following sections we shall see how authorities of the HCUs and particularly Dept. of Health & Family Welfare are spending a huge amount without making any official or agency exclusively responsible to look after the in-house management.

3. Whether the health workers are **aware, motivated, trained and sincere?**

In most of the HCUs there is a general **awareness** that BMW is to be separately collected and handed over to CBWTF vehicles or disposed of separately. A large section of the health workers know that BMW is generated through clinical and surgical activities. But level of awareness varies among different categories of staff. Doctors' concern of and awareness on BMW was found to be relatively low. At least 70% of nursing staff in



government HCUs and 90% of nursing staff in private HCUs have apparent awareness about BMW. But many of them are not very clear about the methods of segregation. Again level of awareness among Gr. D staff and scavengers is poor but relatively better than the doctors. Information, education and communication (IEC)

materials were found grossly inadequate in almost all the hospitals. In most cases, health workers, particularly nurses, who have to segregate waste at

source, have to depend upon memory and practice. HCUs connected with CBWTFs could display IEC (Information, Education and Communication) posters provided by CBWTFs at every point of generation but apart from very few exceptions, this was not observed during the survey.

Motivation is something which is grossly absent among the health and BMW management workers. The issue of occupational safety of the health and BMW management workers vis-à-vis the hazards of bio-medical waste is seldom prioritized. Any process of inculcation is also absent. Most of the health workers consider BMW management as another extra responsibility which is to be discharged along with other assigned duties, and thus as an extra burden. They do not consider it as a necessity for patients' and their own safety. Of course there are a few exceptions. A few heads of the HCUs and nurses were found to be quite motivated to take extra initiative to implement BMW management in proper manner. But generally motivation is absent.

During the period of WBHSDP, an organized effort was taken for conduction of **training** for the nurses and Gr. D and Scavenging workers. Almost all the secondary hospitals were covered. Though there were some limitations and only off-the-job trainings were conducted, a good understanding was developed among the health workers. A six months' monitoring by external agencies was also very effective in developing better quality of management. But in course of time the impact of such trainings and monitoring reduced considerably. Several causes may be pointed out - new recruitments uninitiated to BMW management practices, non-availability of implements, poor in-house administration etc. In private hospitals, even in the large ones, any initiative of organized training has not been taken. A few sporadic efforts were there but those fall much short of the necessity. On-the-job training and refresher training programmes were never undertaken.

Sincerity towards BMW management is conspicuously absent in most of the HCUs under study. The administration is yet to rise to the occasion. Most of the health workers consider the job of BMW management as an extra burden and attach less importance to this. Majority of these workers are otherwise sincere to their jobs. It may be inferred that in absence of awareness, motivation and proper training they show serious lack of sincerity in BMW management.

4. Whether **sharp management instruments** are available and whether **sharp management** is performed properly?

Ideally all the syringes should be cut from their hubs. The defanged needles, after a primary treatment in sodium hypochlorite / bleach solution should be kept in a puncture proof container. Broken ampoules, glasses and obsolete scalpels are also to be put in the puncture proof container. Large CBWTFs

provide scope for collection of these sharp wastes directly in a larger puncture proof container placed in their vehicles. They also offer to provide small puncture proof containers to be placed at generation points.

In case of stand alone treatment facilities puncture proof containers containing sharp waste should be autoclaved and then shredded. But in such facilities with microwave needles, being metal cannot be treated.



It was observed that sharp management instruments are available in most of the

HcUs under survey. But in government HcUs around 50% of the needle cutters are of poor quality and there are complaints that those do not function properly. In municipal HcUs sharp management instruments were rarely available.

Due to lack of motivation and training, sometimes nurses in government hospitals do not properly use the instruments even if those are available and functioning. In most of the HcUs, irrespective of government and private, the cut needles and other sharp wastes are not placed in puncture proof containers. These are disposed of in waste bags which are by no means puncture proof. These bags containing sharp waste are transported by waste handlers. This practice poses severe threat of prick injury and infection. In some HcUs it was found that cut needles are placed card board boxes (like sweet shop boxes) and disposed of in blue bags. But card board boxes get soiled and needles get mixed up with other waste.

Further, in some other HcUs, it was found that the syringes with needles, after use, instead of being cut, are recapped and disposed of in bags. Recapped syringes do not pose threat of prick injury during transportation but recapping itself is unsafe for the health workers performing recapping. This erroneous practice also provides scope of illegal re-use of syringes.

In Medical College, Kolkata and Diamond Harbour SDH, cut needles disposed of in blue bags are again taken out from bags at the treatment points as metals are not allowed in microwave. Thereafter these are disposed in the

general waste stream posing enormous risk and providing scope of illegal re-use.

5. Whether **mutilation equipments** are available and **mutilation** is done in proper manner?

There is not much conscious effort for mutilation of the plastic materials like IV sets, tubes, plastic bottles etc. Where mutilation takes place, generally scissors and knives are used to mutilate. Mainly in private HCUs regular practice of mutilation was found to exist. In government and municipal HCUs such mutilation is seldom done.

There is some confusion regarding character of the used saline bottles. There is a strong opinion that these are not infectious waste. In most of the government HCUs saline bottles are not mutilated and were found to be stored in stacks for selling to recycling agents.

6. Whether **bins and bags** are **available** and **placed at proper places**?

Bags with colour codes and bins are generally available in private and government HCUs. But in municipal HCUs these are seldom available. However there are confusions regarding colour codes. Three of four private HCUs under survey are connected with CBWTFs and follow their guidelines. In case of government HCUs many connected to CBWTFs do not follow their guidelines. While CBWTF system prescribes yellow and blue bags and



puncture proof containers, these govt. HCUs still use red, yellow and blue bags as was prescribed in Health System Development Project which no longer exists. However, the guideline of the Dept. of H&FW, issued with Circular No. HF/O/MS/316/W-99/2008 dtd. 28.5.09, clearly prescribed use of colour codes in

coordination with CBWTF system. Also, in the case of HCUs having autoclaves or microwaves as stand-alone facilities the department has issued instruction to treat only blue bags containing Cat 7 in autoclave or microwave

and handover other categories of waste in yellow bags and puncture proof containers to CBWTFs.

Placement of bins was found erroneous almost everywhere with a very few exceptions. BMW bins should be placed at the points of generation, at places inaccessible to others except the generators of BMW. Usually this should be placed in nursing stations, under OT tables, at immunization places etc. It is advised to use a trolley with BMW bins and bags in case of generation of BMW during bedside treatment. After specific activity these wastes should be taken to nursing stations. But during the survey it was found that BMW bins are placed in balconies, at patients' bedsides, in OPD general areas etc.,



giving access not only to patients but also to all the visitors. As a result a large amount of general waste is disposed of in BMW bins. In case of well equipped private hospitals (nursing homes) BMW bags are available in plenty and kept at every bedside. In case of other hospitals, where supply is not abundant, the BMW bins and bags are placed at wrong places like corridors, OPD waiting areas and other common places. . However, the above mentioned guideline of the Dept. of H&FW, issued with Circular No. HF/O/MS/316/W-99/2008 dtd. 28.5.09, provided detailed suggestions regarding proper placement of BMW bins.

7. Whether **segregation at source** is done in proper manner?

Proper segregation is the key factor of any waste management. But apart from a few exceptions, in almost all the HCUs, quality of segregation is very poor. Mixing is rampant. There is least concern about proper segregation among the health workers and the administrators. Items of BMW are disposed of in any of the bags including bags meant for general waste even if appropriate bins and bags are available. Again, general wastes are often disposed of in BMW bags. Lack of awareness, motivation, training and monitoring among the administrators, doctors, nurses, medical attendants

and scavenging workers is very much conspicuous through the wrong practice of segregation.

It was found that the health workers often dispose of packaging of medicines and medical equipments in BMW bags. There is wide spread confusion regarding use of blue and yellow (and red!) bags. Lot of soiled materials like cotton, gauzes and bandage were found in blue bags. Again plastic items were received in yellow bags. Scavenging workers both departmental (regular) and contractors' are seldom aware of segregation at source. In many cases, they mix up materials of BMW bags during collection and transportation to vats.



Such erroneous segregation has far reaching adverse effect. In many HCUs, a good number of black bags were found with bio-medical waste. In several MCHs in Kolkata, large black bags were found with dozens of placentas wrapped in small yellow bags inside.

It could be inferred that though at the points of generation Cat 1 wastes were correctly disposed of in yellow bags, scavenging workers, for convenience of transportation, clubbed those together and put in black bags for easy transportation. Black bags are meant for general waste and should not be handed over to CBWTF vehicles. These black bags outwardly appear to contain general waste and so CBWTF vehicles logically do not accept these bags. Naturally such bags find their way in municipal vat. Again in large number HCUs, Cat 7 (mainly composed of plastic and especially PVC wastes) was found in yellow bags. As per CBWTF system yellow bags are directly put to incinerators. The practice not only violates BMW rules, but also poses severe threat of unintentional production of dioxin. A study for dioxin in the vicinity of CBWTFs may be instituted to examine this. Introduction of further sorting of BMW with proper health care measures at the CBWTFs may also be considered to avoid greater risk.

Institute of Child Health was an exception. Here, particularly in the indoor wards, waste items were disposed of meticulously in appropriate bags.

8. Whether **temporary storage facilities** of BMW are available?

Most of the large HCUs (except Bankura MCH and North Bengal MCH) under survey were found to have two temporary storage facilities or vats – one for BMW and another for general waste. Wastes are collected from wards and other facilities of the HCUs and kept in these vats for a short period. Thereafter BMW is transferred to CBWTF vehicles. In case of HCUs having stand-alone facilities, these temporary storage facilities or vats are not used as BMW bags are usually carried directly to the treatment facilities. General waste is transferred to municipal stream. Small HCUs do not have such provisions of temporary storage facilities or vats (they may not need them either). Some of these HCUs have campus pits where BMW is disposed of. In case of others, there is no specific system followed.

During survey it was found that two important HCUs like Bankura MCH and North Bengal MCH have no such temporary storage facilities. They also did not have any BMW management system at all. In case of Bankura MCH, BMW were lying scattered at different places in and around the hospital. In North Bengal MCH buildings are spread over a large area and BMW were disposed of anywhere and everywhere around the buildings. Those are also openly burnt adjacent to the hospital buildings. In case of R. G. Kar MCH position of the BMW vat was improper. The vat had two gates, one at the hospital side (which has been blocked) and the other at the road side. The road side gate is used to store the BMW bags and again transferring to the CBWTF vehicles. There are ample chances of pilferage by the waste pickers and spread of infection.

9. Whether BMW bags are properly **carried and transferred** to storage / stand-alone facilities?

Ideally BMW bags should be collected from each ward and facility of an HCU either at specific intervals or when those are 75% filled up, whichever is earlier. Record should be maintained at every ward or facility regarding colour code and number of bags taken away by the scavenging workers. These BMW bags should be transported in covered trolley to the storage facility. There should be one in-charge of the storage facility and BMW bags should be handed over to this person in-charge maintaining proper record. Without the recording system there is hardly any scope to confirm that the amount of waste produced at different wards / facilities of the HCU reaches the temporary storage facility or vat.

During the survey it was found only Woodlands Hospital maintains this system. Among the government HCUs, only S.S.K.M MCH follows this practice. During quantification survey in Calcutta National MCH, the system was introduced as temporary arrangement to facilitate quantification. Some of the district hospitals having stand-alone treatment facilities partially follow this system. In Coochbehar DH, Imambara DH and Barasat DH, BMW bags were transferred to the in-charges of the treatment facilities maintaining record of BMW bags handed over for treatment. Record of disposal of Cat 1 (which is not transferable to the treatment facility) was not maintained. Elsewhere the system of maintaining records was completely absent. The scavenging workers were allowed to dump the BMW bags in the vats as per their convenience.



10. Whether BMW are properly **transferred or handed over** to the **CBWTF** vehicles?

During the survey it was found that the CBWTF vehicles regularly reported to the HCUs, with which they had contract. The representatives of CBWTFs receive the BMW bags after weighing each bag. Though they have provision only to collect yellow and blue bags, due to confusion in some of the government HCUs regarding use of red bags, they also accepted red bags but generally included those in yellow category. They issued a manifest for each day after receiving waste. They recorded total number and total weight of yellow and blue bags in the manifests. Manifests with such records remained available with the concerned HCUs.

During the survey it was found that private HCUs delivered justifiable number of bags corresponding to their bed strength and occupancy. Some of the government HCUs like S.S.K.M MCH, Deben Mahato (Purulia) DH, Vidyasagar SGH also delivered almost justifiable quantity of waste to the CBWTF vehicles. But in other government HCUs, amount of waste transferred to CBWTF vehicles, as was evident from the records, were quite meager and unjustifiable. There are specific examples like Chittaranjan Cancer Hospital, BG & ID Hospital, Nil Ratan Sarkar MCH which did not transfer any BMW bag for days together though the CBWTF vehicles

regularly visited these HCUs. There is ample evidence of sheer wastage of government funds. The Dept. of H&FW, as per contract, was paying Rs. 4.95 per bed to the CBWTF operators on the basis of occupancy but the BMW workers of the corresponding HCUs were not transferring any BMW bags to them day after day. One reason might be salvaging or pilferage of a portion of BMW in connivance with unscrupulous staff. But the major portion of BMW in bedded HCUs belonging to Cat 6 (soiled cotton, gauzes, bandage etc.) does not have any recycling value. At least these should have gone to the CBWTF vehicles. But insincerity and callousness of the staff coupled with authorities' indifference made such irregularities continue for a long time. Anyone can verify this just having a look over the manifests issued by the CBWTF representatives. In NRS Hospital, during the survey, average quantity of BMW received at vat, amounted to 32 grams per bed per day. This is absurd. In the same hospital there was a concrete tube called hopper through which general waste was to be thrown down from any floor to be collected and led to municipal waste disposal stream. A good amount of soiled BMW (Cat 6) was being disposed of through hoppers and those went to municipal waste vat.

11. Whether any portion of BMW is **salvaged** or **pilfered**?

During the survey it was found that a good amount of bio-medical waste went to market without undergoing any decontamination and / or treatment. In many large government HCUs, there were nexus between waste handlers and illegal traders. Mainly Cat 7 items, which have good recyclable



value, are directly pilfered from such HCUs. In Calcutta National MCH, DISHA team came across such a trader, who demanded on record (audio-visual) that she brought her vehicle and collected bio-medical waste in a regular manner from scavenging workers on payment. In Bankura MCH such waste is openly sold to traders. Weighing of such waste in the hospital compound had been recorded. In R. G. Kar MCH waste pickers were found

to pilfer such BMW bags, which were kept at the door of the BMW vat. They also collected such waste from open municipal vat. Such activities were recorded. Such waste picking of BMW could easily be seen every morning at the gate of R. G. Kar MCH. In Kolkata Medical College it was recorded that only 5 to 6 blue bags per day were transferred to on-site facility whereas at least 30 to 40 such bags of BMW should have been disposed of.

In private hospitals, so far studied, such salvaging of waste was not apparent. The quantities of waste handed over to the CBWTF representatives were almost justifiable with occupancy of the HCUs.

12. Whether **personal protective equipments (PPE)** are available and used by the health workers?

Generally in large government HCUs contractors are appointed for conduction of waste handling activities. Scavenging workers carry the BMW bags from wards / facilities to storage point or vat. They also hand over the BMW bags to the CBWTF vehicles wherever called for. Personal protective equipments are supplied to such scavenging workers by the contractors as per terms of contract. During survey it was observed that the scavenging workers partially used such PPEs as per their convenience. Aprons and shoes were generally used. But gloves and masks were seldom put on.

In smaller government HCUs and municipal HCUs Gr. D staff were responsible of carrying BMW. They generally did not use PPEs. In several cases it was alleged that PPEs were not regularly supplied to them. In large private hospitals, most of the staff responsible for handling BMW usually used PPEs.

Conclusion

In short it can be concluded that though the infrastructure for treatment of BMW in the state is almost adequate and highest authorities including monitoring body have started to wake up to the issue, overall status of in-house management of BMW in the HCUs especially which are owned by government or municipalities, are not at all up to the mark.

**MERCURY IN
HEALTH CARE WASTE**

The Context

Mercury, both in its elemental and compound form, is one of the most poisonous substances known to us.

Mercury may be fatal if inhaled and harmful if absorbed through the skin. Around 80% of the inhaled mercury vapour is absorbed in the blood through the lungs. The long-term limit is a billionth of a gram (1ng) per litre of air. This is easily exceeded in a closed room containing exposed mercury. Acute effects result from the inhalation of air containing mercury vapour at concentrations in the range 0.05-0.35 mg/m³. Exposure for a few hours to 1-3 mg/m³ may give rise to pulmonary irritation and destruction of lung tissue and occasionally to central nervous system disorders. Mercury may cause harmful effects to the nervous, digestive, respiratory, immune systems and to the kidneys, besides causing lung damage. Adverse health effects from mercury exposure can be: tremors, impaired vision and hearing, paralysis, insomnia, emotional instability, developmental deficits during fetal development, and attention deficit and developmental delays during childhood. Recent studies suggest that mercury may have no threshold below which some adverse effects do not occur.

The environmental chemistry of mercury depends on both organic and inorganic forms, which differ considerably in their toxic effects, although all are hazardous.

Inorganic mercury compounds [chiefly Hg (II)] can cause intestinal, liver, and kidney damage, but unlike the metallic vapour cannot easily enter the brain cells, and effects may be reversible.

Organomercury compounds are much more toxic. These compounds are lipid soluble, and since higher organisms do not decompose and excrete them effectively, small amounts in the environment tend to be concentrated in organic tissues in the food chain. Mercury is particularly toxic when metabolized into methyl mercury. In its methylated form, mercury is bio-accumulative, biomagnifying and persistent, and threatens the health of humans and wildlife throughout the globe. Dimethylmercury are readily transferred into cells and even through the placental barrier to the fetus. Organomercury can be found in water systems and is concentrated in biological materials.

Apart from its presence in the environment from natural sources, mercury gets released into the environment from various industrial processes, medical establishments and institutions of laboratories. Once in the general environment mercury will eventually make its way to aquatic systems where it is readily transformed by microorganisms into methylated mercury, which ultimately enter the food chain.

Health-care facilities are one of the main sources of mercury release into the environment. The breakage of mercury thermometers and blood pressure devices exposes patients and health care workers to environmental hazards, while also contributing to the global burden of mercury. Health-care facilities are also responsible for mercury pollution taking place in water bodies from the release of untreated wastewater. According to a 1999 report cited by the World Health Organisation, health-care facilities may have been responsible for as much as 5% of all mercury releases in wastewater. In the United States, according to US Environmental Protection Agency (EPA) in a 1997 report, medical waste incinerators may have been responsible for as much as 10% of all mercury air releases.

In health care establishments, mercury is used or is present in different domains.

First, mercury is contained in many common medical measuring devices:

- Sphygmomanometers (blood pressure devices)
- Thermometers (specifically body temperature thermometers but also others)

Secondly, it is used in other medical devices:

- Gastro-intestinal devices, such as cantor tubes, weighed esophageal dilator (Maloney or Hurst bougie), weighted feeding tubes of the older variety and Miller Abbott tubes.

Thirdly, in certain chemicals used in the microbiological (cytopathological and histological) context.

One of the most copious uses of mercury in health care seems to be that of dentistry – mercury amalgams used in dental fillings.

Dental amalgam contains approximately 50% elemental mercury, 30% silver and 20% other metals such as copper, tin and zinc.

Use of mercury in the dental sector has an impact on the downstream environment. Mercury-containing waste from dental clinics often ends up in aquatic environments and the atmosphere through improper disposal. In addition, the primary source of mercury in municipal wastewater effluents generally originates from dental practices.

Environment Canada has estimated that more than one-third of the mercury load in sewage systems is due to dental practice.

Reduction of Mercury in health care sector

The European Union countries have already banned mercury thermometers in 2008. EU is also considering a similar ban on sphygmomanometers. Several EU countries as well as more than a dozens states in the U.S. have also already successfully phase-out mercury blood pressure devices. The World Health Organization and Health Care Without Harm are leading a global initiative to phase-out of mercury-based medical devices globally by 2017. United Nations Environment Programme (UNEP) is instrumental in developing a legally binding treaty among the member countries to reduce anthropogenic mercury use in all sectors especially in health care.

- In February 2010, the Ministry of Health of Argentina published an Administrative Order banning mercury sphygmomanometers. It gave 90 days to end production and 180 to end any commercialization of these products.

- In February, 2009, the Argentine Ministry of Health issued a resolution ending purchase of mercury medical devices in all argentinean hospitals.

- The Philippines issued an Administrative Order in 2008 calling for the phase-out of all mercury based medical devices across the country by 2010. By the Department of Health's Administrative Order 2008-0221, all mercury equipment from hospitals, including mercury-in-glass thermometers, will be phased out in the Philippines by September 28, 2010.

- Taiwan has banned mercury thermometers.

- Over the past decade the United States health care sector has virtually phased out mercury-based medical devices. It is nearly impossible to purchase a mercury thermometer in the United States today.

- Sweden, the Netherlands and Denmark have successfully phased out all mercury based medical devices, including sphygmomanometers.

- Since the 1980s, Cuba has implemented a national policy of replacing its mercury sphygmomanometers with aneroid devices purchased from China.

Indian Situation

In India however, the absence of such regulations were conspicuous. Indeed the awareness level in India regarding ill effects of mercury is exceedingly low, often to the point of being non-existent. Even in the scientific community and industrial sector, the available information has failed to generate sufficient sensitivity. For others, information regarding health hazards of mercury is not institutionally available.

But very recently an important development has taken place. Ministry of Health and Family Welfare has issued a guideline with its order **F. No. Z.28015/24/09-MH II dated 8.3.2010** instructing all Central Government health establishments to phase out mercury containing equipments. Following is the relevant portion of the guidelines:

“1. All Central Government Hospital and Health Centres are advised to gradually phase out mercury containing equipments (thermometers, BP instruments etc.) and replacement with good quality non mercury equipments, in order to prevent toxic effects of mercury on patients and health care workers. It is recommended that a mercury phase-out plan be developed to start procurement of new equipment which is mercury-free.”

The guidelines also recommended proper management of mercury waste until mercury based equipments are fully phased out. This seems to be a definite step forward to phase out mercury from health care sector. Earlier, Delhi government also took a similar decision and started phasing out of all mercury containing equipments in hospitals in Delhi since 2008. Delhi Pollution Control Committee also issued notice to all health care units to take action for safe management of mercury waste.

Situation in West Bengal

During survey it was revealed that there is least awareness among the health workers even up to the level of heads of the HCUs regarding hazardous effect of mercury. At least in 90% cases it transpired that this was the first time that they heard about any such problem.



Though the issue has been discussed in number of occasions in different forums, the state government has not taken any decision to phase out mercury containing equipments in HCUs. However during the conduction of Health System Development Project, guidelines were issued for management of mercury spill. This has been restated in the operational guidelines recently issued by the H&FW department in 2009.

During implementation of State Health System Development Project, such mercury spill management was instituted in several secondary level HCUs. Traces of such effort could be found only in Imambara Sadar Hospital, Hooghly where mercury containing kits were found in every ward. Another interesting practice could be found in Malbazar SDH where 11 digital thermometers were found in use. In some

HCU's like Institute of Child Health several aneroid BP instruments were found in use though no conscious decision to avoid mercury instrument was behind it.

Besides these few exceptions all the thermometers and BP instruments used in the HCU's under study were mercury equipments. During survey it was found that almost all the nurses could remember some incidents of breakage of mercury thermometers. But neither did they follow any proper procedure of spill management nor did they have any knowledge regarding any instruction in the matter. Some of the nurses in National MCH and Institute of Child Health also informed that both the HCU's are situated in disturbance prone area and in several occasions, during mob disturbance, BP instruments were thrown off and broken. Incidents of breakage of mercury instruments are not recorded in any of the HCU's. Some sensitization efforts were taken in Woodlands Hospital during survey of in-house management. Immediately after that, during quantification study, two broken thermometers were received at the waste quantification point. These were recorded and spilled mercury was recovered and preserved in a water filled container. But there is no confirmation that the practice of recording and management will continue.

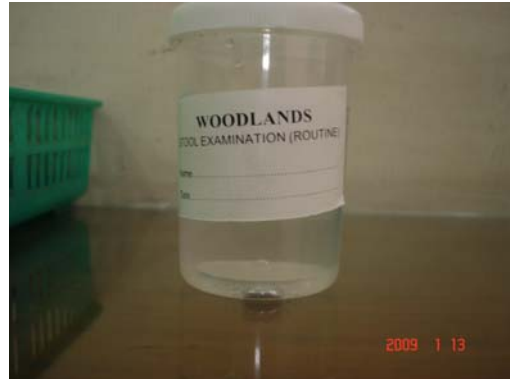

It was observed that all the patients admitted in Woodlands and AMRI were prescribed to buy their own thermometers. Presumably, all the hospitals of that category, prescribed their in-patients to buy a thermometer for their individual use. So a huge number of mercury thermometers are sold. Of course there are chances of resale as most of the patients do not take back their thermometers to home. However, such abundant use provides scope of generation of more mercury waste.

Health sector being one of the important anthropogenic sources of contributing mercury in environment should be more sensible and avoid using mercury equipments and compounds as far as practicable.

Quantification of Mercury Waste

During quantification of bio-medical waste in selected health care units, an effort was made to assess the quantity of mercury waste generated in those units. Enquiries were made in other important HCUs also during study of compliance status of BMW management in the Medical College Hospitals, District Hospitals and some other important hospitals in the state.

It was found that in general there is no system of mercury waste management in almost all the selected HCUs. There was least awareness regarding the problem of mercury waste. Some difference was observed in Imambara Sadar Hospital, (Hoogly District Hospital) and Mal Bazar SDH, Jalpaiguri. In Imambara Sadar Hospital mercury containment kits were available in most of the wards. In Malbazar SDH digital thermometers instead of mercury thermometers are being used. But none of the HCUs in the state maintains any record of generation of mercury waste. It appeared that before going to conduct such quantification, a programme needs to be undertaken to sensitize the health workers of a particular HCU so that any and every occurrence of spill is recorded. Use of dental amalgams is also to be recorded to understand the proportion of mercury exit. Such study is to be conducted over a specified period. The present study did not have that scope as it had to depend upon the observations of existing records and practices.

However an indirect method was applied for this purpose. Enquiry was made with the store departments of respective bedded HCUs to ascertain purchase of average number of new thermometers in a year. **Average number of thermometers required and purchased** has been equated in this study with **number of consumptions or breakages**. Such efforts were also made regarding sphygmomanometers (Blood Pressure measuring instruments) and other mercury containing instruments but these are replaced irregularly and no dependable data was available. In case of dental amalgam also no proper record of cases of fillings could be obtained.

In case of large private hospitals, purchase of thermometers could not be ascertained for a particular reason. In such HCUs, all the indoor patients are advised to buy their own thermometers. In fact the first kit that comes from the pharmacy for every patient on admission contains a thermometer. The patients are advised to take back their own thermometers to their homes. These hospitals also do not maintain any record of mercury spillage / accident. As huge number of thermometers is used in these hospitals, chances of spillage / accident are also very high. But this could not be accounted for. Estimate of consumptions of mercury thermometers in these HCUs have been taken at par with other bedded hospitals.

Average consumption of thermometers per year in bedded HCUs of the state is presented in the following table. Annual release of mercury due to breakage of

thermometers in the HCUs has been further calculated on the basis of the consumption of thermometers:

Average Consumption of Mercury Thermometers in HCUs		
Name of HCUs	Bed strength	Consumption in 1 year
Bankura Sammilani Medical College & Hospital	1217	250
Burdwan Medical College & Hospital	1099	220
North Bengal Medical College & Hospital	1000	250
Calcutta National Medical College	1260	250
R.G. Kar Medical College & Hospital	1107	220
S.S.K.M. Hospital	1650	320
Suri Sadar Hospital	500	120
M.J.N. Hospital - Coochbehar	400	100
Dist. Hospital Dakshin Dinajpur - Balurghat	300	80
District Hospital - Darjeeling	308	60
Siliguri District Hospital	320	60
Purba Medinipore Dist. Hospital	336	70
Imambara Sadar Hospital, Hooghly	540	100
Howrah District Hospital	544	100
Sadar Hospital - Jalpaiguri	610	150
M.R. Bangur Hospital	600	150
District Hospital -Malda	600	100
District Hospital - Murshidabad	391	80
District Hospital - Nadia (Sadar Wing)	495	100
District Hospital - Nadia (Shaktinagar Wing)	400	80
District Hospital - Barasat,	500	100
Deben Mahato Hospital (Dist. Hospital)	500	100
Raiganj Dist. Hospital, Uttar Dinajpur	168	30
S.D. Hospital - MAL	100	20
S.D. Hospital - Bishnupur	230	50
Birpara State General Hospital	100	30
Vidyasagar State General Hospital	256	50
Taldangra Rural Hospital	30	10
Kharibari Rural Hospital	30	10
Anchuri BPHC	10	5
Matigara BPHC	10	5
Bagdogra PHC	10	5
Panchmura PHC	6	2
Dum Dum Municipality Specialised Hospital	110	20
Municipality Hospital, Vivekananda Palli, Malda	18	5
Balurghat Municipal Hospital and Matri Sadan	30	5
Titagarh Maternity Home	12	3
Gr. Total	15797	3310
Average annual consumption of thermometer per 100 beds in Bedded HCUs	21 (Rounded off)	

Mercury Waste Generated from Thermometer

In the previous section it has been estimated from survey in 37 bedded HCUs that average number of breakage of thermometers per 100 beds in a year = 21.

An ordinary fever thermometer contains .5 to 3 gms of mercury. For our calculation, average has been assumed as 1.5 gms per thermometer. Hence district-wise generation:

Mercury Waste Generated in West Bengal Only from Thermometers in Bedded HCUs			
District	Bed Strength	Estimated No. of Thermometers Broken per year	Estimated spill in gms.
Bankura	3774	793	1189
Birbhum	2567	539	809
Burdwan	9910	2081	3122
Coochbihar	1916	402	604
Dakshin Dinajpur	821	172	259
Darjeeling	4800	1008	1512
East Midnapore	2781	584	876
Hooghly	6713	1410	2115
Howrah	4964	1042	1564
Jalpaiguri	2651	557	835
Kolkata	28041	5889	8833
Malda	1782	374	561
Murshidabad	4161	874	1311
Nadia	6519	1369	2053
North 24 Parganas	9587	2013	3020
Purulia	2403	505	757
South 24 Parganas	3833	805	1207
Uttar Dinajpur	844	177	266
West Midnapore	4882	1025	1538
Gr. Total	102949	21619	32429

Thus annual generation of mercury waste only from thermometers in bedded HCUs amounts to **32.429 Kg**. It is to be kept in mind that one spoonful of mercury can contaminate a large lake. When 1 microgram of mercury can pose serious health risk, generation and spill of around 32 Kg elemental mercury waste only from thermometers in bedded HCUs alone must be a serious concern.

RECOMMENDATIONS

Recommendations

Previous chapters include detailed discussion on various problems and shortcomings encountered in the management of bio-medical waste in West Bengal. The Summary Recommendations appended with the Executive Summary indicated possible solutions to the problems in brief and general terms. A list of detailed recommendations is furnished here to provide a better understanding of the same so that appropriate actions may be taken.

Common Bio-Medical Waste Treatment Facilities (CBWTFs)

1. Emphasis need to be given specially on **South-West** (East and West Midnapore), **West** (Bankura, Burdwan, Birbhum Purulia) and **North** (Coochbehar, Jalpaiguri, Darjeeling, Uttar Dinajpur, Dakshin Dinajpur and Malda) regions to pursue the HCUs to come under agreement with CBWTFs of respective areas.
2. Initiative should be taken to install 3 more CBWTFs - **1 in South 24 Parganas** (30000 bed capacity), **1 in Hoogly** (15000 bed capacity) and **1 in Malda or Dakshin Dinajpur** (15000 bed capacity).
3. Since due to improper collection mixing of waste is very common phenomena, a good amount of recyclable materials including PVC are coming to CBWTFs mixed with incinerable waste. Plastic waste, especially PVC should not be burnt. As such feasibility of introducing secondary segregation at CBWTFs with environmental and occupational precautions should be probed.
4. Incineration ash generated in CBWTFs should be regularly and properly disposed at hazardous waste disposal site and records of the same maintained.
5. Tests should be conducted to find presence of dioxin in organic matters and live stocks in the vicinity of the CBWTFs.

In House Management

1. As per BMW Rules heads of the institutions are responsible for bio-medical waste management in respective HCUs. But they are also in-charge of all other activities of the HCUs. To enable proper management there should be one officer in-charge exclusively responsible for in-house BMW management. Particularly in larger HCUs having above 100 beds this should be introduced immediately.
2. Dept. of H&FW, municipal corporations and municipalities need to be pursued to institute regular collection mechanism of BMW from non-bedded HCUs under their jurisdiction and arrange their proper treatment and disposal.

3. A regular monitoring and reporting mechanism should be introduced for every HCU, particularly those having above 100 bed strengths, for periodic review of status of BMW management in respective HCUs. In view of constraints of personnel and expertise, services of NGOs and/or experts should be utilized in this.
4. Both on-the-job and off-the-job training should be imparted at regular intervals to develop awareness and motivation of the health workers at all levels.
5. Regular reporting system with respect to generation, storage and transfer should be maintained to check pilferage, salvaging etc.
6. IEC materials should be displayed at all BMW generation points.
7. Regular supply of good quality working and protective equipments should be ensured.

Mercury Waste

1. Identify all equipments, devices and substances containing or using mercury.
2. Explore and take concrete steps towards eliminating all mercury-containing products and mercury compounds in hospitals and clinical practices especially thermometers, sphygmomanometers - replacing them with non-mercury cost effective products.
3. Pending phasing out of mercury containing equipments and compounds, develop a proper protocol for safe handling and management of existing mercury devices and possible mercury spills and ensure that mercury does not find its way into the waste stream or environment.
4. Train doctors, nurses and other hospital staff to appreciate the reasons and rationale of the protocol and to abide by it.
5. Encourage mercury use reduction and proper waste management procedures in the dental sector, through voluntary and/or regulatory measures. Measures could include implementation of proper waste management procedures and installing amalgam separators at dental clinics to reduce most of the emissions from wastewater.
6. Ensure that controlled mercury disposal and/or storage facilities are available and maintained for all hospitals and health care facilities.

INVENTORY : ANNEXURE - I

DISTRICTWISE LIST OF BEDDED HCUs IN WEST BENGAL

Information Provided:

- A. Name
- B. Address
- C. Organisation
- D. General Category
- E. Special Category

DISTRICT WISE LIST OF BEDDED HCUs IN WEST BENGAL

INVENTORY: ANNEXURE - I

Sl. No	Name of the Units.	Address	Current Bed	Organisation	Category General	Category Special
BANKURA						
1	Bankura Sammilani Medical College & Hospital	P.O. Bankura, Bankura	1217	GOVT	MCH	
2	S.D. Hospital – Bishnupur	P.O. Bishnupur, Bankura	230	GOVT	SD	
3	Khatra Subdivision Hospital	Khatra - I, Bankura	15	GOVT	SD	
4	Gouripur Leprosy Hospital	P.O. Gouripur, Bankura	550	GOVT	SGH	LEPR
5	Kotalpur Rural Hospital	P.O. & P.S. Kotalpur, Dist. Bankura	60	GOVT	RH	
6	Amrakanan Rural Hospital	Amrakanan, Bankura	30	GOVT	RH	
7	Gangajalghati (Amar Kanan) Rural Hospital	Gangajalghati, P.O. Amrakanan, Bankura	30	GOVT	RH	
8	Raipur Rural Hospital	Raipur, P.O. Nutangarh, Bankura	30	GOVT	RH	
9	Sonamukhi Rural Hospital	P.O. Sonamukhi, Bankura	30	GOVT	RH	
10	Taldangra Rural Hospital	Taldangra, Bankura	30	GOVT	RH	
11	Barjora BPHC	Barjora, Bankura	25	GOVT	BPHC	
12	Jaypur BPHC	Jaipur, Bankura	25	GOVT	BPHC	
13	Mejhia BPHC	Mejhia, Bankura	25	GOVT	BPHC	
14	Onda BPHC	Onda, P.O. Medinipur Gram	25	GOVT	BPHC	
15	Patrasayer BPHC	Patrasayer, Patrasayer, P.O. Hat-Krishnanagar, Bankura	25	GOVT	BPHC	
16	Ranibandh BPHC	Ranibandh, Bankura	25	GOVT	BPHC	
17	Radhanagar BPHC	Bishnupur, P.O. Radhanagar, Bankura	21	GOVT	BPHC	
18	Kantasol (Chhatna) BPHC	Chhatna, Bankura	20	GOVT	BPHC	
19	Saltora BPHC	Saltora, Bankura	20	GOVT	BPHC	
20	Amjhuri (Hirbandh) BPHC	Khatra, P.O. Hirbandh, Bankura	15	GOVT	BPHC	
21	Indas (Mirjapur) BPHC	Indas, Bankura	15	GOVT	BPHC	
22	Indpur BPHC	Indpur, Bankura	15	GOVT	BPHC	
23	Kanchanpur BPHC	Kanchanpur, Bankura	15	GOVT	BPHC	
24	Khatra BPHC	Khatra, Bankura	15	GOVT	BPHC	
25	Sarenga BPHC	Raipur, P.O. Sarenga, Bankura	15	GOVT	BPHC	
26	Simlapal BPHC	Simlapal, Bankura	15	GOVT	BPHC	
27	Anchuri BPHC	Bankura –I, P.O. Anchuri, Bankura	10	GOVT	BPHC	
28	Beliatore PHC	Barjora, P.O. Beliatore, Bankura	10	GOVT	PHC	
29	Desra PHC	Kotalpur, P.O. Deopara, Bankura	10	GOVT	PHC	
30	Jagannahpur PHC	Jaipur, P.O. Jagannathpur, Bankura	10	GOVT	PHC	
31	Laugram PHC	Kotalpur, P.O. Karakheria, Bankura	10	GOVT	PHC	

DISTRICT WISE LIST OF BEDDED HCUs IN WEST BENGAL

INVENTORY: ANNEXURE - I

Sl. No	Name of the Units.	Address	Current Bed	Organisation	Category General	Category Special
32	Lego PHC	Kotalpur, P.O. Logo, Bankura	10	GOVT	PHC	
33	Pakhanna PHC	Barjora, P.O. Pakhanna, Bankura	10	GOVT	PHC	
34	Ramsagar PHC	Onda, P.O. Ramsagar, Bankura	10	GOVT	PHC	
35	Sihar PHC	Kotalpur, P.O. Sihar, Bankura	10	GOVT	PHC	
36	Uttarbar PHC	Jaipur, P.O. Magura, Bankura	10	GOVT	PHC	
37	Ajodhya PHC	Bishnupur, P.O. Ajodhya, Bankura	6	GOVT	PHC	
38	Amdangra PHC	Taldangra, P.O. Sabrakon, Bankura	6	GOVT	PHC	
39	Arrah PHC	Simlapal, P.O. Arrah, Bankura	6	GOVT	PHC	
40	Bhagabanpur PHC	Chhatna, P.O. Bhagabanpur, Bankura	6	GOVT	PHC	
41	Bhora PHC	Bishnupur, P.O. Bhora, Bankura	6	GOVT	PHC	
42	Dhulai PHC	Sonamukhi, P.O. Gopikantapur, Bankura	6	GOVT	PHC	
43	Dighalgram PHC	Indas, P.O. Dighalgram, Bankura	6	GOVT	PHC	
44	Gogra PHC	Saltora, P.O. Gogra, Bankura	6	GOVT	PHC	
45	Gopinathpur PHC	Kotalpur, P.O. Gopinathpur, Bankura	6	GOVT	PHC	
46	Gunnath PHC	Indpur, P.O. Gunnath, Bankura	6	GOVT	PHC	
47	Halud Kanali PHC	Ranibandh, P.O. Halud Kanali, Bankura	6	GOVT	PHC	
48	Harmasra PHC	Taldangra, P.O. Harmasra, Bankura	6	GOVT	PHC	
49	Helna Susunia PHC	P.O. Helna Susunia, Bankura	6	GOVT	PHC	
50	Hetia PHC (Panchayat Management)	Hetia, Jaipur	6	GOVT	PHC	
51	Hijaldiha PHC	Jaipur, P.O. Hijaldiha, Bankura	6	GOVT	PHC	
52	Jhantipahari PHC	Chhatna, P.O. Jhantipahari, Bankura	6	GOVT	PHC	
53	Jhilmili PHC	Ranibandh, P.O. Jhilmili, Bankura	6	GOVT	PHC	
54	Jorhira PHC	Chhatna, P.O. Jorhira, Bankura	6	GOVT	PHC	
55	Kankila PHC	Bishnupur, P.O. Kankila, Bankura	6	GOVT	PHC	
56	Kashtora PHC	Saltora, P.O. Kashtora, Bankura	6	GOVT	PHC	
57	Kenjakura PHC	P.O. Kenjakura, Bankura	6	GOVT	PHC	
58	Khejuria PHC (run by Ranibandh Panchayet)	Ranibandh, P.O. Khejuria, Bankura	6	GOVT	PHC	
59	Krishnapur PHC	Raipur, P.O. Krishnapur, Bankura	6	GOVT	PHC	
60	Lakshmisagar (Rasikpur) PHC	Simlapal, P.O. Lakshmisagar, Bankura	6	GOVT	PHC	
61	Mankanali PHC	P.O. Manakanali, Bankura	6	GOVT	PHC	
62	Molian (Shyamnagar) PHC	Khatra, P.O. Molian, Bankura	6	GOVT	PHC	
63	Nikunjapur PHC	Onda, P.O. Nikunjapur, Bankura	6	GOVT	PHC	

DISTRICT WISE LIST OF BEDDED HCUs IN WEST BENGAL

INVENTORY: ANNEXURE - I

Sl. No	Name of the Units.	Address	Current Bed	Organisation	Category General	Category Special
64	Panchal PHC	Sonamukhi, P.O. Panchal, Bankura	6	GOVT	PHC	
65	Panchmura PHC	Taldangra, P.O. Panchmura, Bankura	6	GOVT	PHC	
66	Purba Naldanga PHC	Patrasayer, P.O. Roll, Bankura	6	GOVT	PHC	
67	Ratanpur PHC	Onda, P.O. Ratanpur, Bankura	6	GOVT	PHC	
68	Saldiha PHC	Indpur, P.O.. Saldiha, Bankura	6	GOVT	PHC	
69	Santore PHC	Onda, P.O. Garh Kotalpur	6	GOVT	PHC	
70	SitaljhorePHC	Sonamukhi, P.O. Sitaljhore, Bankura	6	GOVT	PHC	
71	Akui PHC	Indas, P.O. Akui, Bankura	4	GOVT	PHC	
72	Barrah PHC	P.O. Narrah, Bankura	4	GOVT	PHC	
73	Bonabaid PHC	Khatra, P.O. Kankradara, Bankura	4	GOVT	PHC	
74	Chhandar PHC	Barjora, P.O. Chhandar, Bankura	4	GOVT	PHC	
75	Gangajalghati PHC	Gangajalghati, Bankura	4	GOVT	PHC	
76	Godardihi (Jagannathpur) PHC	Barjora, P.O. Godardihi, Bankura	4	GOVT	PHC	
77	Hatgram PHC	Indpur, P.O. Hatgram, Bankura	4	GOVT	PHC	
78	Hatibari PHC	Simlapal, P.O. Bon Dubrajpur, Bankura	4	GOVT	PHC	
79	Ituri PHC	Saltora, P.O. Tiluri	4	GOVT	PHC	
80	Kundu Pushkarini PHC	Sonamukhi, P.O. Kundu Pushkarini, Bankura	4	GOVT	PHC	
81	Matgoda PHC	Raipur, P.O. Matgoda, Bankura	4	GOVT	PHC	
82	Mirjapur PHC	Kotalpur, P.O. J.J. Mirjapur, Bankura	4	GOVT	PHC	
83	Mosiara (Dharampur) PHC	Khatra, P.O. Mosiara, Bankura	4	GOVT	PHC	
84	Nakaijuri PHC	Onda, P.O. Ghorasol, Bankura	4	GOVT	PHC	
85	Pandua (Kushadwip) PHC	Patrasayer, P.O. Kushadwip, Bankura	4	GOVT	PHC	
86	Phulkusma PHC	Raipur, P.O. Phulkusma, Bankura	4	GOVT	PHC	
87	Ramchandrapur PHC	Mejhia, P.O. Ramchandrapur, Bankura	4	GOVT	PHC	
88	Ramhariapur PHC (Swami Vivekananda)	Gangajalghati, P.O. Ramhariapur, Bankura	4	GOVT	PHC	
89	Srichandrapur PHC	Gangajalghati, P.O. Srichandrapur, Bankura	4	GOVT	PHC	
90	Balsi PHC	Patrasayer, P.O. Balsi, Bankura	2	GOVT	PHC	
91	Barikul PHC	Ranibandh, Barikul, Bankura	2	GOVT	PHC	
92	Bibarda PHC	Taldangra, P.O. Bibarda	2	GOVT	PHC	
93	Dumurtor (Tikarpara) PHX	Raipur, Dumurtor, Bankura	2	GOVT	PHC	
94	Keneti PHC	Indas, P.O. Santasram Indus, Bankura	2	GOVT	PHC	
95	Pairasole PHC	Mejhia, P.O. Pairasole, Bankura	2	GOVT	PHC	

DISTRICT WISE LIST OF BEDDED HCUs IN WEST BENGAL

INVENTORY: ANNEXURE - I

Sl. No	Name of the Units.	Address	Current Bed	Organisation	Category General	Category Special
96	Salchura (Kamalpur) PHC	Chhatna, P.O. Kamalpur, Bankura	2	GOVT	PHC	
97	Simla PHC	Khatra, P.O. Gpeswar, Bankura	2	GOVT	PHC	
98	R.L.T.R.R.I. Gouripur	P.O. Gouripur, Bankura	50	GOVT	CG	
99	Gorabari Irrigation Hospital	Khatra, P.O. Gorabari, Bankura	7	GOVT	SGI	
100	Bankura Jail Hospital	P.O. & Dist. Bankura	8	GOVT	SGJ	
101	Bankura Police Hospital	P.O. & Dist. Bankura	12	GOVT	SGP	
102	Bankura Leposy Home & Hospital	Bankura -I, Bankura	168	PVT	N.HOME	LEPR
103	Khristiya Seva Niketan	Vill & P.O.: Sarenga, Dist. Bankura	120	PVT	N.HOME	
104	Dr. B.N. Dutta Medical Centre	Katjuridanga, P.O. Kenduadihi, Bankura	30	PVT	N.HOME	
105	Muktakeshi Arogya Niketan	Jogesh Pally, Nutanchati, P.O. Bankura, Bankura	30	PVT	N.HOME	
106	Camelia Health Care	Vill. & P.O. Kotalpur, Bankura	24	PVT	N.HOME	
107	Mallabhum Nursing Home & Investigation Centre	Bishnupur Station Road, P.O. Bishnupur, Bankura	20	PVT	N.HOME	
108	Nityananda Arogya Niketan	Nitya Nanda Ashrama Road, Nutanganj, P.O. & Dist. Bankura	20	PVT	N.HOME	
109	Bankura Nursing Home	Patpur, P.O. & Dist., Bankura	15	PVT	N.HOME	
110	Bankura Nursing Home	P.O.Bishnupur, Bankura	15	PVT	N.HOME	
111	Bankura Seva Niketan,	Jail Road, Rabindra Sarani, P.O. & Dist. Bankura	15	PVT	N.HOME	
112	City Nursing Home	Rampur, P.O. & Dist. Bankura	15	PVT	N.HOME	
113	Dr. Manick Chandra Nandy's Nursing Home	Pratapbagan , P.O. Bankura, Bankura	10	PVT	N.HOME	
114	Dr. R.B. Sarkar Memorial Nursing Home	Rabindra Sarani, P.O. & Dist. Bankura	10	PVT	N.HOME	
115	Dr. S.B. Roy Katjuridanga Maternity & Nursing Home	Katjuridanga, P.O. Kenduadihi, Bankura	10	PVT	N.HOME	
116	Jeeban Deep Nursing Home	Schooldanga, Bankura	10	PVT	N.HOME	
117	Joy Gobinda Sinha Nursing Home	Chandmaridanga, P.O. & Dist. Bankura	10	PVT	N.HOME	
118	Kotulpur Nursing Home	P.O. Kotulpur, Bankura	10	PVT	N.HOME	
119	Lake View Nursing Home	Sova Bhavan, Mutukganj, P.O. Bishnupur, Bankura	10	PVT	N.HOME	
120	Life Line Nursing Home	Stadium More Patpur, P.O. & Dist. Bankura	10	PVT	N.HOME	
121	Lions Club of Bankura Welfare Trust	Kesikola, Bankura	10	PVT	N.HOME	
122	Little Heart Children Hospital Pvt. Ltd.,	271/7/1, Taragoti Samanta Rd, P.O.Kenduadihi, Ban-722102	10	PVT	N.HOME	
123	Maa Mahamaya Maternity & Nursing Home	Kenduadihi, P.O. Kenduadihi, Bankura	10	PVT	N.HOME	
124	Memorial Nursing Home	Abinash Sarani, P.O. & Dist. Bankura	10	PVT	N.HOME	
125	New Aparupa Nursing Home	Nutanchati By Pass Rd, Bankura	10	PVT	N.HOME	
126	Sarenga Nursing Home & Maternity	Vill & P.O. - Sarenga, Bankura	10	PVT	N.HOME	

DISTRICT WISE LIST OF BEDDED HCUs IN WEST BENGAL

INVENTORY: ANNEXURE - I

Sl. No	Name of the Units.	Address	Current Bed	Organisation	Category General	Category Special
127	Savier Maternity & Nursing Home	Machantala, near Municipality office, P.O. & Dist. Bankura	10	PVT	N.HOME	
128	Sonamukhi Pragati Netralay	Ranibazar, P.O. Sonamukhi, Bankura	10	PVT	N.HOME	
129	Souren Eye Clinic & Nursing Home	Nutanchati, P.O. & Dist. Bankura	10	PVT	N.HOME	
130	Binapani Nursing Home	K.K. Bazar, P.O. Bisnupur, Bankura	9	PVT	N.HOME	
131	Nursing Home – Pratapbagan	P.O. & Dist. Bankura	9	PVT	N.HOME	
132	Anathbandhu Seva Sadan	Rabindra Sarani, P.O. & Dist. Bankura	8	PVT	N.HOME	
133	Basuli Maternity & Nursing Home	Chhatna, P.O. Chhatna, Bankura	8	PVT	N.HOME	
134	Chandroday Sales & Service (P) Ltd.	Rambaghat Bajoria Sarani, Lalbazar, Bankura	7	PVT	N.HOME	
135	Hope Medicare	Lalbazar, Bankura	7	PVT	N.HOME	
136	Astha Nursing Home & Maternity	Churamonipur, Sonamukhi, Bankura	6	PVT	N.HOME	
137	Gopinath Nursing Home	Haranath Mandir Road, P.O.: Sonamukhi, Bankura	6	PVT	N.HOME	
138	Sri Nibas Nursing Home	P.O.: Sonamukhi, P.O. & Dist.: Bankura	6	PVT	N.HOME	
139	Aparupa Matrisadan	Natun Chati, By Pass Road, Dist - Bankura - 722 101	5	PVT	N.HOME	
140	Dr. Khudiram De Memorial Nursing Home	Shristi, Schooldanga, P.O. & Dist.: Bankura	5	PVT	N.HOME	
141	Mother Care Nursing Home	Kenduadihi, P.O. Kenduadihi, Bankura	5	PVT	N.HOME	
142	Nabjeeban Nursing Home	Vill - Bangla, P. O. & P. S. : Indpai, Dist: - Bankura	5	PVT	N.HOME	
143	New Biswarupa Maternity & Nursing Home	Rampur, P.O. & Dist. Bankura	5	PVT	N.HOME	
144	Saktipurna Arogya Niketan	Barjora, Bankura	5	PVT	N.HOME	
145	Vijoy Krishna Nursing Home	Sonamukhi, P.O. Sonamukhi, Bankura	5	PVT	N.HOME	
146	Bankura Eye Clinic	Suvankar Sarani, Pratapbagan, P.O. & Dist. Bankura	5	PVT	N.HOME	EYE
147	Dr. Phoni Bhusan Eye Foundation	Baila Park, K.M. High School, Bishnupur. Bankura	4	PVT	N.HOME	
148	Dreamland Nursing Home	Maliara, P.O. Maliara, Bankura	4	PVT	N.HOME	
149	Taldangra Maternity & Nursing Home	P.O. Taldangra, Bankura	4	PVT	N.HOME	
150	Basudeb Nursing Home	Sonamukhi, P.O. Sonamukhi, Bankura	3	PVT	N.HOME	
		TOTAL NUMBER OF BEDS IN BANKURA DISTRICT:	3774			
BIRBHUM						
1	Siuri Sadar Hospital	P.O. Siuri, Birbhum	500	GOVT	DH	
2	S.D. Hospital – Rampurhat	P.O. Rampurhat, Bolpur	286	GOVT	SD	
3	S.D. Hospital – Bolpur	P.O. Bolpur, Birbhum	125	GOVT	SD	
4	Sainthia Rural Hospital	P.O. Sainthia, Birbhum	60	GOVT	RH	
5	Murarai Rural Hospital	Murarai, Birbhum	50	GOVT	RH	
6	Dubrajpur Rural Hospital	Dubrajpur, P.O. Hetampur Rajbati, Birbhum	30	GOVT	RH	

DISTRICT WISE LIST OF BEDDED HCUs IN WEST BENGAL

INVENTORY: ANNEXURE - I

Sl. No	Name of the Units.	Address	Current Bed	Organisation	Category General	Category Special
7	Labpur Rural Hospital	Labpur, P.O. Labpur, Birbhum	30	GOVT	RH	
8	Bolpur BPHC	Bolpur-Sriniketan, P.O. Bolpur, Birbhum	60	GOVT	BPHC	
9	ILLambazar BPHC	ILLambazar, Birbhum	25	GOVT	BPHC	
10	Md. Bazar BPHC	Md. Bazar, P.O. Patelnagar, Birbhum	25	GOVT	BPHC	
11	Nalhathi BPHC	P.O. Nalhathi, Birbhum	25	GOVT	BPHC	
12	Satpalsa (Basudebpur) BPHC	Mayureswar, P.O. Basudevpur, Birbhum	25	GOVT	BPHC	
13	Barachaturi BPHC	Suri, P.O. Khatanga, Birbhum	15	GOVT	BPHC	
14	Baswa BPHC	Rampurhat, P.O. Baswa, Birbhum	15	GOVT	BPHC	
15	Chakmondala BPHC	Rampurhat, P.O. Chakmondala, Birbhum	15	GOVT	BPHC	
16	Lohapur BPHC	Nalhathi – II, P.O. Lohapur, Birbhum	15	GOVT	BPHC	
17	Mollarpur BPHC	Mayureswar, P.O. Mollarpur, Birbhum	15	GOVT	BPHC	
18	Nakrakonda BPHC	Kyayrasole, P.O. Nakrakonda, Birbhum	15	GOVT	BPHC	
19	Nanoor BPHC	Nanoor, Birbhum	15	GOVT	BPHC	
20	Paikar BPHC	Murarai, P.O. Paikar, Birbhum	15	GOVT	BPHC	
21	Rajnagar BPHC	Rajnagar, Birbhum	15	GOVT	BPHC	
22	Sultanpur BPHC	Suri, P.O. Abinashpur, Birbhum	15	GOVT	BPHC	
23	Amarpur PHC	Sainthia, P.O. Gargaria, Birbhum	10	GOVT	PHC	
24	Barrah PHC	Khayrasole, P.O. Barrah, Birbhum	10	GOVT	PHC	
25	Bharmarkole PHC	Sainthia, P.O. Kachuihata, Birbhum	10	GOVT	PHC	
26	Bipratikuri PHC	Labpur, P.O. Bipratikuri, Birbhum	10	GOVT	PHC	
27	Kimahar PHC	Nanoor, P.O. Kirnahar, Birbhum	10	GOVT	PHC	
28	Margram PHC	Rampurhat, P.O. Margram, Birbhum	10	GOVT	PHC	
29	Rajgram PHC	Murarai, P.O. Rajgram, Birbhum	10	GOVT	PHC	
30	Rudranagar PHC	Murarai, P.O. Rudranagar, Birbhum	10	GOVT	PHC	
31	Sonarkundu PHC	Nalhathi – I, p.o. Sonarkundu, Birbhum	10	GOVT	PHC	
32	Tantipara PHC	Rajnagar, P.O. Tantipara, Birbhum	10	GOVT	PHC	
33	Abhadanga PHC	Labpur, P.O. Abhadanga, Birbhum	6	GOVT	PHC	
34	Baidara PHC	Rampurhat, P.O. Haridaspur, Birbhum	6	GOVT	PHC	
35	Bakreswar PHC	Dubrajpur, P.O. Bakreswar, Birbhum	6	GOVT	PHC	
36	Banagram PHC	Nanoor, Birbhum	6	GOVT	PHC	
37	Bhabanipur PHC	Rajnagar, P.O. Bhabanipur, Birbhum	6	GOVT	PHC	
38	Bhimpur PHC	Murarai, P.O. Bhimpur, Birbhum	6	GOVT	PHC	

DISTRICT WISE LIST OF BEDDED HCUs IN WEST BENGAL

INVENTORY: ANNEXURE - I

Sl. No	Name of the Units.	Address	Current Bed	Organisation	Category General	Category Special
39	Chatra PHC	Murarai, P.O. Chatra, Birbhum	6	GOVT	PHC	
40	Dheka PHC	Mayureswar, P.O. Kuliara, Birbhum	6	GOVT	PHC	
41	Dunigram PHC	Rampurhat, P.O. Dunigram, Birbhum	6	GOVT	PHC	
42	Dwarka PHC	Labpur, P.O. Dwarka, Birbhum	6	GOVT	PHC	
43	Hatinagar PHC	Mayureswar, P.O. Kotasur, Birbhum	6	GOVT	PHC	
44	Iswarpur (Ahmedpur) PHC	Sainthia, P.O. Ahmedpur, Birbhum	6	GOVT	PHC	
45	Jajigram PHC	Murarai, P.O. Jajigram, Birbhum	6	GOVT	PHC	
46	Jaydeb Kenduli PHC	Ilambazar, P.O. Joydeb, Birbhum	6	GOVT	PHC	
47	Kachujore PHC	Suri, P.O. Mahubuna, Birbhum	6	GOVT	PHC	
48	Kaitha Idrakpur PHC	Murarai, P.O. Kaitha, Birbhum	6	GOVT	PHC	
49	Kastagora PHC	Rampurhat, P.O. Kastagora, Birbhum	6	GOVT	PHC	
50	Kurumgram PHC	Nalhathi, P.O. Kurumgram, Birbhum	6	GOVT	PHC	
51	Lokepur PHC	Khayrasole, P.O. Lokepur, Birbhum	6	GOVT	PHC	
52	Narayanpur PHC	Rampurhat, P.O. Narayanpur, Birbhum	6	GOVT	PHC	
53	Noapara (Ulakunda) PHC	Mayureswar, P.O. Gunutia, Birbhum	6	GOVT	PHC	
54	Panchra PHC	Khayrasole, P.O. Panchrahat, Birbhum	6	GOVT	PHC	
55	Patanda PHC	Suri, P.O. Ikra, Birbhum	6	GOVT	PHC	
56	Purandarpur PHC	Suri, P.O. Purandarpur, Birbhum	6	GOVT	PHC	
57	Ramkrishnapur PHC	Labpur, P.O. Brahmanigram, Birbhum	6	GOVT	PHC	
58	Ratma PHC	Mayureswar, P.O. Dakshingram Birbhum	6	GOVT	PHC	
59	Sangra PHC	Sainthia, P.O. Chotosangra, Birbhum	6	GOVT	PHC	
60	Sekeddah PHC	Md. Bazar, P.O. Dighalgram, Birbhum	6	GOVT	PHC	
61	Sitalgram PHC	Nalhathi – II, P.O. Sitalgram, Birbhum	6	GOVT	PHC	
62	Srinidhipur PHC	Sainthia, P.O. Purbasiur, Birbhum	6	GOVT	PHC	
63	Supur PHC	Bolpur-Sriniketan, P.O. Rajatpur, Birbhum	6	GOVT	PHC	
64	Talwa PHC	Mayureswar, P.O. Talwa, Birbhum	6	GOVT	PHC	
65	Tarapur PHC	Rampurhat, P.O. Tarapur, Birbhum	6	GOVT	PHC	
66	Udaypur PHC	Rampurhat, P.O. Dekhuria, Birbhum	6	GOVT	PHC	
67	Balijuri PHC	Dubrajpur, P.O. Balijuri, Birbhum	4	GOVT	PHC	
68	Bharkata PHC	Md. Bazar, P.O. Bharkata, Birbhum	4	GOVT	PHC	
69	Jashpur PHC	Dubrajpur P.O. Ghoratore, Birbhum	4	GOVT	PHC	
70	Kaitha PHC	Nalhathi, P.O. Kaitha, Birbhum	4	GOVT	PHC	

DISTRICT WISE LIST OF BEDDED HCUs IN WEST BENGAL

INVENTORY: ANNEXURE - I

Sl. No	Name of the Units.	Address	Current Bed	Organisation	Category General	Category Special
71	Khujutipara PHC	Nanoor, P.O. Khujutipara, Birbhum	4	GOVT	PHC	
72	Puranogram PHC	Md. Bazar, P.O. Puranogram, Birbhum	4	GOVT	PHC	
73	Sattore Kasba PHC	Bolpur-Sriniketan, P.O. Sattore, Birbhum	4	GOVT	PHC	
74	Batkar PHC	Ilambazar, P.O. Batkar, Birbhum	2	GOVT	PHC	
75	Bhadrapur PHC	Nalhathi – II, P.O. Bhadrapur, Birbhum	2	GOVT	PHC	
76	Chakdaha PHC	Suri, P.O. Chakdaha, Birbhum	2	GOVT	PHC	
77	Jatra PHC	Dubrajpur, P.O. Jatra, Birbhum	2	GOVT	PHC	
78	Panchsowa PHC	Bolpur-Sriniketan, P.O. Panchsowa, Birbhum	2	GOVT	PHC	
79	Rampur PHC	Md. Bazar, P.O. Rampur, Birbhum	2	GOVT	PHC	
80	Thiba PHC	Labpur, P.O. Thiba, Birbhum	2	GOVT	PHC	
81	Niramoy TB Sanatorium	Dubrajpur, P.O. Giridanga, Birbhu,	300	GOVT	SANT	TB
82	Pearson Memorial Hospital	Bolpur, P.O. Santiniketan, Birbhum	50	GOVT	CG	
83	Birbhum Police Hospital	P.O. Siuri, Birbhum	20	GOVT	SGP	
84	Suri District Correctional Home	P.O. Siuri, Birbhum	10	GOVT	SGJ	
85	Massanjore Irrigation Hospital	Dumka, P.O. Massangore	2	GOVT	SGI	
86	Rampurhat Rly. Hospital	Rampurhat, Birbhum	2	GOVT	RLY	
87	Sainthia Nursing Home	Sainthia Bazar, Birbhum	25	PVT	N.HOME	
88	Sri Arobindo Society Nursing Home	Salboni, P. O. Karidhya, Suri,	25	PVT	N.HOME	
89	Dr. N.C. Dutta Memorial Hospital	New Hospital Road, Rampurhat, Birbhum	20	PVT	N.HOME	
90	Indralok Nursing Home	Suri, Sonatoripara, Harihat Gung, Birbhum	20	PVT	N.HOME	
91	Siuri Nursing Home	Barabagan, Siuri, Birbhum	20	PVT	N.HOME	
92	St. Joseph Hospital	Nalhathi, P.O. Banior, Birbhum	18	PVT	N.HOME	
93	St. Joseph Hospital	Cilingpor, Siuri, Birbhum	18	PVT	N.HOME	
94	Elmhirst Institute of Community Studies	Naba Bithika Andrewspalli, Shantiniketan, Birbhum	15	PVT	N.HOME	
95	Diwaliben Mehta Suri Linos Eye Care Center	Lalkuthi Para, P.O.: Suri.: Birbhum	10	PVT	N.HOME	EYE
96	Siuri Lions Eye Hospital	Lalkuthi Para, Siuri, Birbhum	10	PVT	N.HOME	EYE
97	St. Johns Ambulance Association (Chowhatta Eye Hospital	Labpur, Birbhum	10	PVT	N.HOME	EYE
98	Adyashakti Medical Centre	Nanoor Chandidas Road, Bolpur, Birbhum	10	PVT	N.HOME	
99	Arogya Niketan	Vill. Shalbani, P.O. Karidaya, Birbhum	10	PVT	N.HOME	
100	Birbhum Nursing Home & Maternity	Sanator Para, Siuri, Birbhum	10	PVT	N.HOME	
101	Bolpur Nursing Home	Chandidas Nanoor Road, Bolpur, Birbhum	10	PVT	N.HOME	
102	Jeevan Rekha Nursing Home	Bolpur Road, Ilambazar, Birbhum	10	PVT	N.HOME	

DISTRICT WISE LIST OF BEDDED HCUs IN WEST BENGAL

INVENTORY: ANNEXURE - I

Sl. No	Name of the Units.	Address	Current Bed	Organisation	Category General	Category Special
103	Joy Durga Nursing Home & Diagnostic	Rabindra Pally, P.O. Siuri, Birbhum	10	PVT	N.HOME	
104	Kirnahar Nursing Home	Kirnahar (Paschimpally), Birbhum	10	PVT	N.HOME	
105	Modern Diagnostic & Nursing Home	Dangalpara, P.O. Siuri, Birbhum	10	PVT	N.HOME	
106	New Life Nursing Home	Chandidas Road, P.O. Bolpur, Birbhum	10	PVT	N.HOME	
107	Nivedita Seva Sadan	Haragauri Tala, Bolpur, Birbhum	10	PVT	N.HOME	
108	Nursing Home & Poly Clinic	Kirnaahat (Paschim Pally), Birbhum	10	PVT	N.HOME	
109	Prodyut Maternity & Nursing Home	Sainthia, Birbhum	10	PVT	N.HOME	
110	R.S. Medicare and Nursing Home	Nalhati, Birbhum	10	PVT	N.HOME	
111	Santiniketan Nursing Home	Bandhgora, Bolpur, Schoolbagan, Birbhum	10	PVT	N.HOME	
112	South View Nursing Home	Raksha Kali Tala Road, Saithia, Birbhum	10	PVT	N.HOME	
113	Life Line Nursing Home	Lalkuthi Para, Siuri, Birbhum	7	PVT	N.HOME	
114	Tagore Eye Care Center	Bandhgora, Sriniketan Road, P.O. & P.S.: Bolpur, Birbhum	6	PVT	N.HOME	EYE
115	Santiniketan Eye Care & Micro Surgery Center	Bolpur, Birbhum	5	PVT	N.HOME	EYE
116	A. K. M. Memorial Nursing Home	Rajarhat, Sirakole, Usti, South 24 Pgs.	5	PVT	N.HOME	
117	Ashirwad Nursing Home	Netaji Subhas Road, Sainthia, Birbhum	5	PVT	N.HOME	
118	Ilambazar Nursing Home	Khaira, P.O.: Ilambazar, Birbhum	5	PVT	N.HOME	
119	Matri Mongal Kendra	Sebarapara, Suri, Birbhum	5	PVT	N.HOME	
120	Medico Diagnostic Center & Nursing Home	Rampurhat, New Hospital Road, Birbhum	5	PVT	N.HOME	
121	Mina Nursing Home	S.P. More, Siuri, Birbhum	5	PVT	N.HOME	
122	Monorama Seva Sadan	Station Road, Bolpur, Birbhum	5	PVT	N.HOME	
123	Naba Jiban	Makarampur, Bolpur, Birbhum	5	PVT	N.HOME	
124	Niramoy Nursing Home	M.N.K. Road, Bharshala Para, Rampurhat, Birbhum	5	PVT	N.HOME	
125	Panrui Nursing Home	Vill, Po. Panrui, Birbhum	5	PVT	N.HOME	
126	Poly Clinic Nursing Home cum Maternity	National High Way, Rampurhat, Birbhum	5	PVT	N.HOME	
127	Rampurhat Nursing Home	Bharsala Para, Rampurhat, Birbhum	5	PVT	N.HOME	
128	Shantiniketan Eye Care & Micro Surgery Center	Mission Compound, Bolpur	5	PVT	N.HOME	
129	Binode Barani Nursing Home	Dholanga Road, Sanghatapara, Rampurhat	4	PVT	N.HOME	
130	Mita Smriti Seva Kendra	Narayanpur, Rampurhat, Birbhum	4	PVT	N.HOME	
131	Nalhati Medical Centre	Nalhati Station Road, Birbhum	4	PVT	N.HOME	
132	Netraniketan Eye Care Centre	Suri Sadar Hospital Road, P.O.: Suri, Birbhum	4	PVT	N.HOME	
133	Pratap Nursing Home	Sandhani More, Sainthia, Birbhum	4	PVT	N.HOME	
134	Bakreswar Thermal Power Project (Health Care Unit)	P.O. B.K.T.P.P.(Township), Bakreswar, Birbhum	2	PVT	N.HOME	
		TOTAL NUMBER OF BEDS IN BIRBHUM DISTRICT:	2567			

DISTRICT WISE LIST OF BEDDED HCUs IN WEST BENGAL

INVENTORY: ANNEXURE - I

Sl. No	Name of the Units.	Address	Current Bed	Organisation	Category General	Category Special
BURDWAN						
1	Burdwan Medical College & Hospital	Burdwan	1099	GOVT	MCH	
2	S.D. Hospital – Katwa	Katwa, Dist. Burdwan	250	GOVT	SD	
3	S.D. Hospital – Asansol(Asansol L.M. Hospital)	S. B. Gorain Road, Asansol, Dist. Burdwan	205	GOVT	SD	
4	S. D. Hospital – Durgapur	Durgapur, Dist. Burdwan	164	GOVT	SD	
5	S.D. Hospital – Kalna	Kalna, Dist. Burdwan	151	GOVT	SD	
6	Memari Rural Hospital	P.O. Memari, Dist. Burdwan	60	GOVT	RH	
7	Ballabhpur Rural Hospital	P.O. Ballabhpur, Raniganj, Dist. Burdwan	50	GOVT	RH	
8	Bhatar Rural Hospital	P.O. Bhatar, Dist. Burdwan	50	GOVT	RH	
9	Singot Rural Hospital	P.O. Mathrun, Mangalkote, Dist. Burdwan	50	GOVT	RH	
10	Chandpur (Srirampur) Rural Hospital	P.O. Vidyannagar, Purbasthali, Dist. Burdwan	30	GOVT	RH	
11	Mankar Rural Hospital	P.O. Mankar, Galasi, Dist. Burdwan	30	GOVT	RH	
12	Srirampur Rural Hospital	Srirampur, Bardhaman	30	GOVT	RH	
13	Raniganj BPHC	P.O. Raniganj, Dist. Burdwan	25	GOVT	BPHC	
14	Adrahati BPHC	P.O. Adrahati, Galasi, Dist. Burdwan	15	GOVT	BPHC	
15	Atghoria BPHC	P.O. Atghoria, Kalna, Dist. Burdwan	15	GOVT	BPHC	
16	Badla (Chagram) BPHC	P.O. Gram-Chagram, Kalna, Dist. Burdwan	15	GOVT	BPHC	
17	Bahadurpur BPHC	P.O. Bahadurpur, Jamuria, Dist. Burdwan	15	GOVT	BPHC	
18	Barakar BPHC	P.O. Brakar, Kulti, Dist. Burdwan	15	GOVT	BPHC	
19	Bon Nabagram BPHC	P.O. Bon Nabgram, Dist. Burdwan	15	GOVT	BPHC	
20	Jamalpur BPHC	P.O. Jamalpur, Dist. Burdwan	15	GOVT	BPHC	
21	Jamtara BPHC	P.O. Amaragarh, Dist. Burdwan	15	GOVT	BPHC	
22	Kandra (Ramjibanur) BPHC	P.O. Jnandas Kandra, Ketugram, Dist. Burdwan	15	GOVT	BPHC	
23	Kelejhora BPHC	P.O. Domohani Bazar, Barabani, Dist. Burdwan	15	GOVT	BPHC	
24	Ketugram BPHC	P.O. Ketugram, Dist. Burdwan	15	GOVT	BPHC	
25	Khandaghosh BPHC	P.O. Khandaghosh, Dist. Burdwan	15	GOVT	BPHC	
26	Kurmun BPHC	P.O. Kurmun, Burdwan	15	GOVT	BPHC	
27	Ludaha BPHC	P.O. Ludaha, Faridpur, Dist. Burdwan	15	GOVT	BPHC	
28	Madhabdihi (Ahar) BPHC	P.O. Chhoto-Bainan, Raina, Dist. Burdwan 203	15	GOVT	BPHC	
29	Maheshbati BPHC	P.O. Raina, Dist. Burdwan	15	GOVT	BPHC	
30	Mangalkote BPHC	P.O. Natunhat, Mangalkote, Dist. Burdwan	15	GOVT	BPHC	
31	Manteswar (Kadambini) BPHC	P.O. Manteswar, Dist. Burdwan	15	GOVT	BPHC	

DISTRICT WISE LIST OF BEDDED HCUs IN WEST BENGAL

INVENTORY: ANNEXURE - I

Sl. No	Name of the Units.	Address	Current Bed	Organisation	Category General	Category Special
32	Noapara BPHC	P.O. Dainhat, Katwa, Dist. Burdwan	15	GOVT	BPHC	
33	Panagarh BPHC	P.O. Panagarh, Kanksa, Dist. Burdwan	15	GOVT	BPHC	
34	Pithaieary BPHC	P.O. Rupnarayanpur, Saanpur, Dist. Burdwan	15	GOVT	BPHC	
35	Purbasthali BPHC	P.O. Purbasthali, Dist. Burdwan	15	GOVT	BPHC	
36	Akalpur BPHC	P.O. Akalpur, Jamuria, Dist. Burdwan	10	GOVT	BPHC	
37	Dihika BPHC	P.O. Dihika, Hirapur, Dist. Burdwan	10	GOVT	BPHC	
38	Khandra (Ukhra) BPHC	P.O. Ukhra, Andal, Dist. Burdwan	10	GOVT	BPHC	
39	Parhati BPHC	P.O. Parhati, Dist. Burdwan	10	GOVT	BPHC	
40	Pursha BPHC	P.O. Pursha, Galsi, Dist. Burdwan	10	GOVT	BPHC	
41	Srikhanda BPHC	P.O. Srikhanda, Katwa, Dist. Burdwan	10	GOVT	BPHC	
42	Baidyapur PHC	P.O. Baidyapur, Kalna, Dist. Burdwan	15	GOVT	PHC	
43	Bagnapara PHC	P.O. Bagnapara, Kalna, Dist. Burdwan	10	GOVT	PHC	
44	Barsul PHC	P.O. Barsul, Dist. Burdwan	10	GOVT	PHC	
45	Bitra PHC	P.O. Bitra, Dist. Burdwan	10	GOVT	PHC	
46	Chakdighi PHC	P.O. Chakdighi, Dist. Burdwan	10	GOVT	PHC	
47	Chakshanjadi PHC	P.O. Chakshanjadi, Dist. Burdwan	10	GOVT	PHC	
48	Dakshin Dhaka PHC	P.O. Dakshin Dhaka, Asansol, Dist. Burdwan	10	GOVT	PHC	
49	Debipur PHC	P.O. Debipur, Dist. Burdwan	10	GOVT	PHC	
50	Dhanyakherur (Majhergram) PHC	P.O. Madhyamgram, Manteswar, Dist. Burdwan	10	GOVT	PHC	
51	Durgapur PHC	P.O. Chatkhanda, Dist. Burdwan	10	GOVT	PHC	
52	Erruar PHC	P.O. Erruar, Dist. Burdwan	10	GOVT	PHC	
53	Gushkara PHC	P.O. Gushkara, Dist. Burdwan	10	GOVT	PHC	
54	Kaity PHC	P.O. Kaity, Dist. Burdwan	10	GOVT	PHC	
55	Nabagram (Shibloon) PHC	P.O. Shibloon, Ketugram, Dist. Burdwan	10	GOVT	PHC	
56	Satinandi PHC	P.O. Khana Jn. Galasi, Dist. Burdwan	10	GOVT	PHC	
57	Sultanpur PHC	P.O. Sultanpur, Kalna, Dist. Burdwan	10	GOVT	PHC	
58	Akalpous PHC	Kalna, P.O. Akalpous, Dist. Burdwan	6	GOVT	PHC	
59	Amarpur PHC	P.O. Aduri, Dist. Burdwan	6	GOVT	PHC	
60	Andal PHC	P.O. Andal, Dist. Burdwan	6	GOVT	PHC	
61	Angadpur PHC	P.O. Durgapur, Faridpur, Dist. Burdwan	6	GOVT	PHC	
62	Baktarnagar PHC	P.O. Baktarnagar, Raniganj, Dist. Burdwan	6	GOVT	PHC	
63	Barapalasan PHC	Barapalasan, Dist. Burdwan	6	GOVT	PHC	

DISTRICT WISE LIST OF BEDDED HCUs IN WEST BENGAL

INVENTORY: ANNEXURE - I

Sl. No	Name of the Units.	Address	Current Bed	Organisation	Category General	Category Special
64	Barwa PHC	P.O. Barsa, Pandebswar, Dist. Burdwan	6	GOVT	PHC	
65	Bharatpur PHC	P.O. Panagarh Bazar, Galasi, Dist. Burdwan	6	GOVT	PHC	
66	Bidyanandapur (Suryanagar) PHC	P.O. Suryanagar, Hirapur, Dist. Burdwan	6	GOVT	PHC	
67	Bijpur PHC	P.O. Basuda, Dist. Burdwan	6	GOVT	PHC	
68	Bohar PHC	P.O. Bohar, Dist. Burdwan	6	GOVT	PHC	
69	Chanak Kasem PHC	P.O. Kasemnagar, Mangalkote, Dist. Burdwan	6	GOVT	PHC	
70	Chanderpur PHC	P.O. Chanderpur, Katwa, Dist. Burdwan	6	GOVT	PHC	
71	Chinchuria PHC	P.O. Chinchuria, Jamuria, Dist. Burdwan	6	GOVT	PHC	
72	Churulia (Pramila Nazrul) PHC	P.O. Churulia, Jamuria, Dist. Burdwan	6	GOVT	PHC	
73	Dabor PHC	P.O. Achra, Salanpur, Dist. Burdwan	6	GOVT	PHC	
74	Dignagar PHC	P.O. Dignagar, Dist. Burdwan	6	GOVT	PHC	
75	Domohani PHC	P.O. Domohani Bazar, Barabani, Dist. Burdwan	6	GOVT	PHC	
76	Goswami Khanda (Ramnagar) PHC	P.O. Uttar Ramnagar, Dist. Burdwan	6	GOVT	PHC	
77	Gotan PHC	P.O. Gotan, Dist. Burdwan	6	GOVT	PHC	
78	Kaithan PHC	P.O. Kaithan, Katwa, Dist. Burdwan	6	GOVT	PHC	
79	Kantaberia PHC	P.O. Dhabani, Faridpur, Dist. Burdwan	6	GOVT	PHC	
80	Kulley PHC	P.O. Kulley, Dist. Burdwan	6	GOVT	PHC	
81	Lowapur PHC	P.O. Lowapur, Faridpur, Dist. Burdwan	6	GOVT	PHC	
82	Mainampur PHC	P.O. Mainampur, Manteswar, Dist. Burdwan	6	GOVT	PHC	
83	Malandighi PHC	P.O. Malandighi, Kanksa, Dist. Burdwan	6	GOVT	PHC	
84	Nabagram PHC	P.O. Nabagram, Dist. Burdwan	6	GOVT	PHC	
85	Nadanghat PHC	P.O. Nadanghat, Purbasthali, Dist. Burdwan	6	GOVT	PHC	
86	Narugram PHC	P.O. Narugram, Dist. Burdwan	6	GOVT	PHC	
87	Nasigram PHC	P.O. Nasigram, Dist. Burdwan	6	GOVT	PHC	
88	Negon PHC	P.O. Negon, Mangalkote, Dist. Burdwan	6	GOVT	PHC	
89	Nimdah PHC	Belarhat, Purbasthali, Dist. Burdwan	6	GOVT	PHC	
90	Nuni PHC	P.O. Nuni, Barabani, Dist. Burdwan	6	GOVT	PHC	
91	Palla Road PHC	P.O. Palla Road, Dist. Burdwan	6	GOVT	PHC	
92	Pandabeswar PHC	P.O. Andal, Dist. Burdwan	6	GOVT	PHC	
93	Pandabeswar PHC	P.O. Pandebswar, Dist. Burdwan	6	GOVT	PHC	
94	Patuli PHC	P.O. Patuli, Purbasthali, Dist. Burdwan	6	GOVT	PHC	
95	Punuria PHC	P.O. Punuria, Barabani, Dist. Burdwan	6	GOVT	PHC	
96	Puthuri PHC	P.O. Puthuri, Manteswar, Dist. Burdwan	6	GOVT	PHC	

DISTRICT WISE LIST OF BEDDED HCUs IN WEST BENGAL

INVENTORY: ANNEXURE - I

Sl. No	Name of the Units.	Address	Current Bed	Organisation	Category General	Category Special
97	Sahajpur PHC	P.O. Sahajpur, Kalna, Dist. Burdwan	6	GOVT	PHC	
98	Shibpur PHC	P.O. Shibpur, Kanksa, Dist. Burdwan	6	GOVT	PHC	
99	Shilampur PHC	P.O. Shilampur, Kanksa, Dist. Burdwan	6	GOVT	PHC	
100	Shyambazar PHC	P.O. Shyambazar, Kanksa, Dist. Burdwan	6	GOVT	PHC	
101	Shyamsundar PHC	P.O. Shyamsundar, Dist. Burdwan	6	GOVT	PHC	
102	Singhi (Kashiram Das) PHC	P.O. Singhi, Katwa, Dist. Burdwan	6	GOVT	PHC	
103	Sirisdanga PHC	P.O. Mandi, Jamuria, Dist. Burdwan	6	GOVT	PHC	
104	Sudpur PHC	P.O. Sudpur, Katwa, Dist. Burdwan	6	GOVT	PHC	
105	Tirat PHC	Raniganj, Tirat, Dist. Burdwan	6	GOVT	PHC	
106	Agradwip PHC	P.O. Agradwip, Katwa, Dist. Burdwan	4	GOVT	PHC	
107	Baghar PHC	P.O. Baghar, Dist. Burdwan	4	GOVT	PHC	
108	Bahadurpur PHC	P.O. Eral, Dist. Burdwan	4	GOVT	PHC	
109	Bhatkunda PHC	P.O. Bhatkunda, Dist. Burdwan	4	GOVT	PHC	
110	Bhedia PHC	P.O. Bhedia, Dist. Burdwan	4	GOVT	PHC	
111	Bhuri PHC	P.O. Bhuri, Galasi, Dist. Burdwan	4	GOVT	PHC	
112	Bonpass PHC	P.O. Bonpass, Dist. Burdwan	4	GOVT	PHC	
113	Dogachhia PHC	P.O. Raidogachhia, Purbasthali, Dist. Burdwan	4	GOVT	PHC	
114	Gobindapur PHC	P.O. Kasiara, Dist. Burdwan	4	GOVT	PHC	
115	Illsarah PHC	P.O. Illsarah, Dist. Burdwan	4	GOVT	PHC	
116	Jamar PHC	P.O. Karar, Dist. Burdwan	4	GOVT	PHC	
117	Khudkuri PHC	P.O. Sankari, Dist. Burdwan	4	GOVT	PHC	
118	Kubajpur PHC	P.O. Muksimpara, Purbasthali, Dist. Burdwan	4	GOVT	PHC	
119	Meral PHC	P.O. Meral, Dist. Burdwan	4	GOVT	PHC	
120	Painta PHC	P.O. Painta, Dist. Burdwan	4	GOVT	PHC	
121	Pandugram PHC	P.O. Khatundi, Ketugram, Dist. Burdwan	4	GOVT	PHC	
122	Pitambar (Torkona) PHC	P.O. Torkona, Dist. Burdwan	4	GOVT	PHC	
123	Sahebganj PHC	P.O. Sahebganj, Dist. Burdwan	4	GOVT	PHC	
124	Sevasadan (Nowapara) PHC	P.O. Nowapara, Purbasthali, Dist. Burdwan	4	GOVT	PHC	
125	Sitahati PHC	P.O. Sitahati, Ketugram, Dist. Burdwan	4	GOVT	PHC	
126	Angarson (Hazi Osmangani) PHC	P.O. Pindira, Kalna, Dist. Burdwan	2	GOVT	PHC	
127	Ankhona PHC	P.O. Ankhona, Ketugram, Dist. Burdwan	2	GOVT	PHC	
128	Balgona PHC	P.O. Balgona, Dist. Burdwan	2	GOVT	PHC	

DISTRICT WISE LIST OF BEDDED HCUs IN WEST BENGAL

INVENTORY: ANNEXURE - I

Sl. No	Name of the Units.	Address	Current Bed	Organisation	Category General	Category Special
129	Bambhandaipur PHC	P.O. Jyotram, Dist. Burdwan	2	GOVT	PHC	
130	Benodpur PHC	P.O. Pahalanpur, Dist. Burdwan	2	GOVT	PHC	
131	Birkulti PHC	P.O. Birkulti, Jamuria, Dist. Burdwan	2	GOVT	PHC	
132	Damra PHC	P.O. Kalipahari, Asansol, Dist. Burdwan	2	GOVT	PHC	
133	Dhenua PHC	P.O. Dhenua, Hirapur, Dist. Burdwan	2	GOVT	PHC	
134	Khirgram PHC	P.O. Khirgram, Mangalkote, Dist. Burdwan	2	GOVT	PHC	
135	Kurmardihi PHC	P.O. Sitarampur, Kulti, Dist. Burdwan	2	GOVT	PHC	
136	Lakhuria PHC	P.O. Lakhuria, Mangalkote, Dist. Burdwan	2	GOVT	PHC	
137	Lalganj PHC	P.O. Lalganj, Barabani, Dist. Burdwan	2	GOVT	PHC	
138	Lowa PHC	P.O. Dwamuri, Galasi, Dist. Burdwan	2	GOVT	PHC	
139	Marichkota PHC	P.O. Ethora, Asansol, Dist. Burdwan	2	GOVT	PHC	
140	Parbatpur PHC	P.O. Parbatpur, Salanpur, Dist. Burdwan	2	GOVT	PHC	
141	Singhari Adarsa Palli (Lakhimpur) PHC	P.O. Lakhimpur, Purbasthali, Dist. Burdwan	2	GOVT	PHC	
142	Sodpur PHC	P.O. Sodpur, Kulti, Dist. Burdwan	2	GOVT	PHC	
143	Subaldaha PHC	P.O. Borobainan, Dist. Burdwan	2	GOVT	PHC	
144	Tehatta PHC	P.O. Tehatta, Kalna, Dist. Burdwan	2	GOVT	PHC	
145	Dr. L. Sen Memorial Leprosy Hospital	Asansol, Dist. Burdwan	50	GOVT	AMBH	LEPR
146	Raniganj Leprosy Home	Raniganj, Dist. Burdwan	50	GOVT	AMBH	LEPR
147	Durgapur Steel Plant Hospital	J.M. Sengupta Road, Durgapur, Dist. Burdwan,	590	GOVT	SAIL	
148	Burnpur Hospital	Burnpur, Dist. Burdwan	550	GOVT	IISCO	
149	Eastern Rly. Hospital	Asansol, Dist. Burdwan	220	GOVT	RLY	
150	Kasturba Gandhi Hospital	Chittranjan Locomotive Works, Chittaranjan, Dist. Burdwan	197	GOVT	RLY	
151	Ondal Rly Hospital	Ondal, Dist. Burdwan	50	GOVT	RLY	
152	Burdwan Rly Hospital	P.O. Burdwan, Dist. Burdwan	5	GOVT	RLY	
153	C.R.P.F. Hospital	Amrabati, Durgapur, Burdwan	40	GOVT	DEF	
154	The Durgapur Projects Ltd. Hospital	Durgapur, Dist. Burdwan	106	GOVT	DPL	
155	DVC Hospital	Durgpur, Dist. Burdwan	30	GOVT	DVC	
156	Central Hospital (Kalla)	Asansol, Kalla, Dist. Burdwan	450	GOVT	ECL	
157	Sanctoria Hospital	Kulti, Dishergarh, Dist. Burdwan	275	GOVT	ECL	
158	Bankola Area Hospital	Ondal, Ukhra, Dist. Burdwan	50	GOVT	ECL	
159	Bansara Hospital,	Raniganj, P.O. Bansara, Dist. Burdwan	50	GOVT	ECL	
160	Mandabari Hospital (Panth Nagar)	Raniganj, Pandebswar, Dist. Burdwan	50	GOVT	ECL	

DISTRICT WISE LIST OF BEDDED HCUs IN WEST BENGAL

INVENTORY: ANNEXURE - I

Sl. No	Name of the Units.	Address	Current Bed	Organisation	Category General	Category Special
161	Regional Hospital	Ondal, Bohula, Dist. Burdwan	50	GOVT	ECL	
162	Salanpur Hospital	Barabani, Salanpur, Dist. Burdwan	50	GOVT	ECL	
163	TB Hospital (Searsol)	Raniganj, Searsol Rajbati, Dist. Burdwan	50	GOVT	ECL	TB
164	Satgram Hospital	Jamuria, Debchandnagar, Dist. Burdwan	40	GOVT	ECL	
165	Sripur Hospital	Jamuria, Sripur, Dist. Burdwan	40	GOVT	ECL	
166	Khaskajhora Colliery Hospital	Kulti, P.O. Kajora, Dist. Burdwan	15	GOVT	ECL	
167	Burdwan Jail Hospital	Burdwan, Dist. Burdwan	35	GOVT	SGJ	
168	Asansol Spl. Jail Hospital	Asansol, Dist. Burdwan	20	GOVT	SGJ	
169	E.S.I. Hospital	Asansol, Kanyapur, Dist. Burdwan	85	GOVT	SGL	
170	Burdwan Police Hospital,	P.O. & Dist. Burdwan	44	GOVT	SGP	
171	Medical Unit-cum Hospital, R.E College	Durgapur, Dist. Burdwan	6	GOVT	SGE	
172	The Mission Hospital (Durgapur Medical Centre Pvt. Ltd.)	Immon Kalyan Sarani, Sector - 2C, Durgapur - 12, Bardwan	237	PVT	N.HOME	
173	Anandalok Hospital	N.S.B. Road, P.S.: Raniganj, Asansol, Burdwan	116	PVT	N.HOME	
174	Vivekananda Hospital (P) Ltd.	Dr. Zakir Hossain Avenue, Bidhannagar, Durgapur, Burdwan	115	PVT	N.HOME	
175	Raniganj Lions Makhnial Jhunjhunwala Memor Eye Hospital	N.S.B. Road, Raniganj, Asansol, Burdwan	94	PVT	N.HOME	
176	Marwari Relief Society Hospital	1, N.S.B. ROAD, Raniganj, Dist. Burdwan	85	PVT	N.HOME	
177	Astha Hospital	Hanuman Charai, P.O.: Barakar, Dist. Burdwan	50	PVT	N.HOME	
178	B.N.Agarwal Memorial Hospital	B/24 & C/24, N.S.B. Road, P.O. & P.S.: Raniganj, Burdwan	50	PVT	N.HOME	
179	C A M R I	Bamachandaipur, Dist. Burdwan.	50	PVT	N.HOME	
180	HLG Memorial Charitable Hospital & Research Institute (P) Ltd.	Sen-Releigh Road, Asansol, Burdwan	50	PVT	N.HOME	
181	India Red Cross Society (Burdwan Dist. Branch No. 133)	Kachari Road Court Compound, Burdwan – 713 101.	50	PVT	N.HOME	
182	Kedar nath Memorial Hospital	Searsol Rajbari, Asansol, Burdwan	50	PVT	N.HOME	
183	Satgram Area Hospital	P.O. Devchandannagar, P.S. Jamuria, Dist. Burdwan	50	PVT	N.HOME	
184	Asansol Medical Centre (P) Ltd.	Chelidanga, G.T. Road, Asansol, Burdwan	45	PVT	N.HOME	
185	Life Nursing Home	33/1, P. N. Malia Road, Raniganj, Asansol, Burdwan	45	PVT	N.HOME	
186	Jeevan Deep Nursing Home	16, D.N. Lane, Dist. Burdwan.	40	PVT	N.HOME	
187	Jupitar Clinic & Nursing Home (P) Ltd.	Begunia, Barakar, Burdwan	40	PVT	N.HOME	
188	Dafodil Nursing Home	Upper Chelidanga, Asansol, Burdwan	35	PVT	N.HOME	
189	The Memorial Clinic Nursing Home	Gopalpur, G. T. Road, Asansol, Burdwan	34	PVT	N.HOME	
190	The Life Line Nursing Home & Polyclinic	35/11, Keshab Ganj, 294, G. T. Road, Burdwan	33	PVT	N.HOME	
191	Anada Niketan Rural Cancer detection & Management Center	Vill & P.O.Sudpur, Dist. Burdwan	30	PVT	N.HOME	CAN
192	Burdwan Nursing Home	Ramkrishna Road, Ranisayer, Dist. Burdwan.	30	PVT	N.HOME	

DISTRICT WISE LIST OF BEDDED HCUs IN WEST BENGAL

INVENTORY: ANNEXURE - I

Sl. No	Name of the Units.	Address	Current Bed	Organisation	Category General	Category Special
193	City Clinic	Doctors Colony, Durgapur, Burdwan	30	PVT	N.HOME	
194	Diplomat Nursing Home	14, R.B. Ghosh Road, Dist. Burdwan.	30	PVT	N.HOME	
195	Durgapur City Clinic & Nursing Home (P) Ltd.	City Centre, Durgapur – 16, Burdwan	30	PVT	N.HOME	
196	Manasi Arogya Niketan	Kanainatshal, Dist. Burdwan.	30	PVT	N.HOME	
197	Raniganj Nursing Home	Searsol, Rajbari, Asansol, Burdwan	30	PVT	N.HOME	
198	Kalyani Nursing Home	40, R. B. Ghosh Road, Dist. Burdwan.	28	PVT	N.HOME	
199	Kamalaya Hospital (P) Ltd.	194, G. T. Road, Asansol	26	PVT	N.HOME	
200	H.K. Nursing Home	Khoshbagan, Dist. Burdwan.	25	PVT	N.HOME	
201	Kumar P. N. Malia Hospital	Serasol, Rajbari, Raniganj, Burdwan	25	PVT	N.HOME	
202	Parijat Sebalaya Pvt. Ltd.	Power House Para, Shyam Sayer (N) Dist. Burdwan.	25	PVT	N.HOME	
203	Park Nursing Home	12, Fraser Avnue, Power House Para, Dist. Burdwan.	25	PVT	N.HOME	
204	Lal Baba Matri Sadan	P.O.: Birudiha, P.S.: Kanksa, Burdwan	24	PVT	N.HOME	
205	Adarsa Nursing Home	160, B. C. Road, Rajbati, Sulipukur, Dist. Burdwan.	22	PVT	N.HOME	
206	Mahananda Cancer Hospital	Benachiti, Durgapur, Burdwan	20	PVT	N.HOME	CAN
207	Mohananda Cancer Diagnostic Reseach Welfare Society	Rangamati Path, Bidhannagar, Durgapur	20	PVT	N.HOME	CAN
208	Apolo Nursing Home	36, R. B. Ghosh Road, Khoshbagan, Dist. Burdwan.	20	PVT	N.HOME	
209	Aurobinda Nursing Home	Kalla Bye Pass, Asansol, Burdwan	20	PVT	N.HOME	
210	Bidhan Niramoy Nursing Home	B - 120, Aldrin Path, Bidhan Nagar, Durgapur, Burdwan	20	PVT	N.HOME	
211	Burdwan Nightingale Nursing Home	26, J.B. Mitra Road, P.O. Rajbati, Dist. Burdwan	20	PVT	N.HOME	
212	Care and Cure Nursing Home	43, Ramkrishna Road, Khoshbagan, Burdwan	20	PVT	N.HOME	
213	Central Nursing Home	58, D.N. Mitra Lane, Meena Hati, Dist. Burdwan.	20	PVT	N.HOME	
214	Coalfield Nursing Home	NSB Road, Raniganj, Asansol, Burdwan	20	PVT	N.HOME	
215	Eve Land Nursing Home	Madhuban (BaidyaPur More) Po. Kalna Burdwan.	20	PVT	N.HOME	
216	Kalna Nursing Home	Lakshmanpara, Kalna, Burdwan	20	PVT	N.HOME	
217	Mother Land Nursing Home	Khoshbagan, Dist. Burdwan.	20	PVT	N.HOME	
218	Nabajiban Mental Health & Neurological Center	Punuri Road, Kulti, Burdwan	20	PVT	N.HOME	
219	Nabajiban Nursing Home	Ranjala Road, Asansol, Burdwan	20	PVT	N.HOME	
220	New Eveland Nursing Home	Sem Religh Road, Apear Garden, Asansol, Burdwan	20	PVT	N.HOME	
221	Nightingale Nursing Home	Mahajantuli, 26, J.B. Mitra Lane, Dist. Burdwan.	20	PVT	N.HOME	
222	Presidency Nursing Home	Nandalal Bithi, City Center, Durgapur, Burdwan	20	PVT	N.HOME	
223	Punarjiban Nursing Home	Kundu Pukur, B.C. Road, Dist. Burdwan.	20	PVT	N.HOME	
224	Shyamview Nursing Home	Shyam Sayer (N), Dist. Burdwan.	20	PVT	N.HOME	

DISTRICT WISE LIST OF BEDDED HCUs IN WEST BENGAL

INVENTORY: ANNEXURE - I

Sl. No	Name of the Units.	Address	Current Bed	Organisation	Category General	Category Special
225	Sisu Mangal Nursing Home	65, B.C. Road, Dist. Burdwan.	20	PVT	N.HOME	
226	Sri Aurobindo Nursing Home	Kalla Bye Pass More, P.O. Kala, Pin. 713340, Dist. Burdwan	20	PVT	N.HOME	
227	Uma Smriti Kalyan Kendra N. Home	Ranisayer (W), Burdwan	20	PVT	N.HOME	
228	Asansol West End Clinic & Nursing Home	Kumarpur, Asansol, Burdwan	19	PVT	N.HOME	
229	Nivedita Nursing Home	Krishna Sayer, Dist. Burdwan.	16	PVT	N.HOME	
230	Lions Eye Care Hospital	33/A, Mallick Bazar, R.B. Ghosh Road, Burdwan	15	PVT	N.HOME	EYE
231	Lions Eye Hospital (Lion Club of Durgapur)	Tagore Avenue, Prantika, Durgapur - 4, Burdwan	15	PVT	N.HOME	EYE
232	Anamoy Poly Clinic & Diagnostic Centre & Nursing Home	P.O. Katjuridanga, Dist. Burdwan	15	PVT	N.HOME	
233	Ankur Nursing Home	95, N.S.B. Road, Serasol, Raniganj, Burdwan	15	PVT	N.HOME	
234	Arogya Niketan Clinic & Nursing Home	Telephone Maidan, P.O. Katwa, Dist. Burdwan	15	PVT	N.HOME	
235	Arogya Nursing Home	Sahara Apartment, G. T. Road, P.O.: Asansol, Burdwan	15	PVT	N.HOME	
236	Asansol Metropolitan Nursing Home	Upper Cheliganga, Asansol, Burdwan	15	PVT	N.HOME	
237	Dreamland Nursing Home	Sanjeeb Sarani, Station Bazar, Durgapur, Burdwan	15	PVT	N.HOME	
238	Gopinath Arogya Niketan	634, S.T.. K.K. Road, Bara Mitra Para, P.O. Kalna, Burdwan	15	PVT	N.HOME	
239	Gouri Nursing Home	Narkel Bagan, Dist. Burdwan.	15	PVT	N.HOME	
240	Hill View Nursing Home	Apcar Garden, Asansol, Burdwan	15	PVT	N.HOME	
241	Kalpataru Nursing Home	46, R.B. Ghosh Rod, Narkelbagan More, Dist. Burdwan.	15	PVT	N.HOME	
242	Nirajan Smriti Kalyan Kendra (p) Ltd.	Shyamsayer (W), Dist. Burdwan.	15	PVT	N.HOME	
243	Seba Nursing Home	Rupnarayanpur, P.O.: Rupnarayanpur Bazar, Asansol, Burdwan	15	PVT	N.HOME	
244	Seba Nursing Home	48, NSB Road, Searsol Rajbari, Raniganj, Asansol, Burdwan	15	PVT	N.HOME	
245	Seva Sadan Nursing Home	Katwa Rabindra Sarani, P.O. Katwa, Dist. Burdwan	15	PVT	N.HOME	
246	The New Florance Nursing Home	Hill View (S), Asansol, Burdwan	15	PVT	N.HOME	
247	Elan View Nursing Home (P) Ltd.,	N – 1, Doctors Colony, Durgapur – 16, Dist. Burdwan	14	PVT	N.HOME	
248	Desai Hospital	124/2 G. T. Road (E), Murgasol, Asansol, Burdwan	12	PVT	N.HOME	
249	Durgapur Society for Prevenson of Thalassaemia & AIDS	Room No. 3, 4 & 5, A-2, Health Centre, Durgapur, Burdwan	12	PVT	N.HOME	
250	Gurudeep Nursing Home	Sadhudanga, Asansol, Burdwan	12	PVT	N.HOME	
251	Matri Sadan Maternity Nursing Home	Kulti Ranitala, P.O.: Kulti, Burdwan	12	PVT	N.HOME	
252	Mangalam Nursing Home	Benachity, Durgapur – 13, Burdwan	11	PVT	N.HOME	
253	Asansol Eye Hospital	36/1, Ram Gulam Singh Road, Ushagram, Asansol, Burdwan	10	PVT	N.HOME	EYE
254	Agarwal Nursing Home	Chittaranjan Road, Neamatpur, P.O.: Sitarampur, Asansol,	10	PVT	N.HOME	
255	Amader Nursing Home	Das Market , Mamra Bazar Durgapur Burdwan	10	PVT	N.HOME	
256	Andal Lions DSM Eye Hospital	North Bazar, Po. Andal, Burdwan	10	PVT	N.HOME	
257	Angel Nursing Home	40, B. C. Road, Khoshbagan, Dist. Burdwan.	10	PVT	N.HOME	

DISTRICT WISE LIST OF BEDDED HCUs IN WEST BENGAL

INVENTORY: ANNEXURE - I

Sl. No	Name of the Units.	Address	Current Bed	Organisation	Category General	Category Special
258	Apurba Nursing Home	Shyamganj, Kalna, Burdwan	10	PVT	N.HOME	
259	Aragya Niketan	Roydanga, Durgapur-I, Burdwan	10	PVT	N.HOME	
260	Arogya Niketan	B.C. Road, Dist. Burdwan.	10	PVT	N.HOME	
261	Asansol Maternity Nursing Home	G. T. Road (W), Kumarpur, Asansol, Burdwan	10	PVT	N.HOME	
262	Ashirbad Seva Sadan	Hanuman Chorai, Barakar, Burdwan	10	PVT	N.HOME	
263	Babu Nursing Home	Kajoragram, Durgapur, Burdwan	10	PVT	N.HOME	
264	Bagala Nursing Home	Bhatar, Dist. Burdwan.	10	PVT	N.HOME	
265	Banku Behari Nursing Home	Burnpur Road, Rabindra Nagar, Asansol, Burdwan	10	PVT	N.HOME	
266	Bengal Nursing Home	B.C. Road, Dist. Burdwan.	10	PVT	N.HOME	
267	Burdwan Manasik Sebasadan	443, B.C. Road, Dist. Burdwan.	10	PVT	N.HOME	
268	Burnpur Nursing Home & Surgical Clinic	Subhaspalli Main Road, P.O.: Burnpur, Burdwan	10	PVT	N.HOME	
269	Central Nursing Home	G.T. Road, Asansol, Burdwan	10	PVT	N.HOME	
270	Central Nursing Home	Nachan Road, Benachity, Durgapur - 13, Burdwan	10	PVT	N.HOME	
271	City Nursing Home	Apcar Garden, G. T. Road (W), Gopalpur, Asansol, Burdwan	10	PVT	N.HOME	
272	Devine Nursing Home	Neamatput, G.T. Raod (W), P.O.: Sitarampur, Kulti, Burdwan	10	PVT	N.HOME	
273	Dr. B.C. Roy Memorial Institute	Doctors Colony, City Center, Durgapur, Burdwan	10	PVT	N.HOME	
274	Gouranga Sengupta Smriti Seva Sadan	Radhanagar Road, Hirapur, P.O.: Burnpur, Asansol, Burdwan	10	PVT	N.HOME	
275	Green Land Nursing Home	Kesabganj Chatti Masjid Tala, P.S. & Dist. Burdwan	10	PVT	N.HOME	
276	Green Land Nursing Home	Khoshbagan, Dist. Burdwan.	10	PVT	N.HOME	
277	Guskara Sevasadan	Guskara Hattala, Guskara, Burdwan	10	PVT	N.HOME	
278	Haripur Nursing Home	Haripur, Asansol, Burdwan	10	PVT	N.HOME	
279	Haritage Nursing Home	D/178, Sasthi Avenue, Bidhan Nagar, Durgapur, Burdwan	10	PVT	N.HOME	
280	IPP - VIII Maternity Home	Alamganj, Jhurjhurapur, Boupur, P.O.: Natunganj, Burdwan	10	PVT	N.HOME	
281	Jagadhatri Nursing Home	Kalna, Burdwan	10	PVT	N.HOME	
282	Jeevandeep Nursing Home	Dr. B.C. Roy Avenue, D.V.C. Colony, Durgapur, Burdwan	10	PVT	N.HOME	
283	Kamala Nursing Home	College More, Kulti, Asansol, Burdwan	10	PVT	N.HOME	
284	Katwa Nursing Home	P.O. Katwa, Dist. Burdwan	10	PVT	N.HOME	
285	Leah Nursing Home	Budha Road, Asansol, Burdwan	10	PVT	N.HOME	
286	Life Care Nursing Home	Munchipara, Durgapur - 12, Dist. Burdwan	10	PVT	N.HOME	
287	Life Care Nursing Home	Karalghat, P.O.: Jamalpur, Burdwan	10	PVT	N.HOME	
288	Life Line Medicare	Lower Chelidanga, Asansol, Burdwan	10	PVT	N.HOME	
289	Life Line Nursing Home	Rahamatnagar, Burnpur, Asansol, Burdwan	10	PVT	N.HOME	

DISTRICT WISE LIST OF BEDDED HCUs IN WEST BENGAL

INVENTORY: ANNEXURE - I

Sl. No	Name of the Units.	Address	Current Bed	Organisation	Category General	Category Special
290	Lions Asansol East ADDA & BS Gopalka Memorial Netralaya & Eye	Kanyapur, Behind All India Radio Complex, Senrleigh Road, Asansol	10	PVT	N.HOME	EYE
291	Ma Durga Nursing Home	Vill. & P.O.: Rajbandh, Burdwan	10	PVT	N.HOME	
292	Ma Durga Nursing Home	26, N.S. Road, P.O. Asansol, Dist. Burdwan	10	PVT	N.HOME	
293	Matri Kalyan Nursing Home	Circus Maidan, P.O. & P.S. Katwa, Dist. Burdwan	10	PVT	N.HOME	
294	Medicare Clinic & Nursing Home	Gopalpur, Asansol, Burdwan	10	PVT	N.HOME	
295	Mental Health Care Centre	1/2, Kanai Natsal North, D.V.C. More, P.O.: Sripally,	10	PVT	N.HOME	
296	Merina Nursing Home	Baramitra Para, Kalna, Burdwan	10	PVT	N.HOME	
297	Midland Nursing Home	Burnpur Road, P.O.: Asansol, Burdwan	10	PVT	N.HOME	
298	Midway Nursing Home	Hanuman Chorai, G.T. Road, P.O. Barakar, Dist. Burdwan	10	PVT	N.HOME	
299	Moon Light Nursing Home	Chandamore, Asansol, Burdwan	10	PVT	N.HOME	
300	Narayani General Hospital	New Road, G. T. Road, Kulti, Burdwan	10	PVT	N.HOME	
301	Neocare Nursing Home	P.O. & P.S.: Raniganj, Burdwan	10	PVT	N.HOME	
302	New Ambika Nursing Home	Lakshmanpara, Kalna, Burdwan	10	PVT	N.HOME	
303	New Life Nursing Home	8, T.K.K. Road, kalna, Burdwan	10	PVT	N.HOME	
304	Nightingale Nursing Home	Gopalpur, G. T. Road, Asansol, Burdwan	10	PVT	N.HOME	
305	Niramoy Nursing Home	1, D.P. Mazumder Lane, Dist. Burdwan.	10	PVT	N.HOME	
306	Panagarh Nursing Home	Panagarh, Durgapur, Burdwan	10	PVT	N.HOME	
307	Popular Nursing Home	37, G.T. Road, Asansol, Burdwan	10	PVT	N.HOME	
308	Pranab Batabyal Smriti Matrisadan O Bahirbibhag	Alamganj, Burdwan	10	PVT	N.HOME	
309	Premier Clinic & Nursing Home	115/1, G.T. Road (W), Asansol – 4, Burdwan	10	PVT	N.HOME	
310	Raj Lakshmi Nursing Home	Sidheswartala, Kalna, Burdwan	10	PVT	N.HOME	
311	Repose Nursing Home	G. T. Road, Panagarh Bazar, Durgapur, Burdwan	10	PVT	N.HOME	
312	Sabitri Nursing Home	Kajora, Durgapur, Burdwan	10	PVT	N.HOME	
313	Sahayam Sundar Nursing Home	Shyam Sundar Bazar, P.S.: Raina, Burdwan	10	PVT	N.HOME	
314	Sanjeevani Nursing Home	Rambagan, Serasole, Raniganj, Burdwan	10	PVT	N.HOME	
315	Santi Clinic and Nursing Home	21/B, Lenin Sarani, P.O. Katwa, Dist. Burdwan	10	PVT	N.HOME	
316	Satellite Nursing Home	Sripally More, S.B. Garai Road, Asansol, Burdwan	10	PVT	N.HOME	
317	Sebalaya Nursing Home	Bhatar, Kadamtala, Dist. Burdwan.	10	PVT	N.HOME	
318	Sebalaya Nursing Home	Kotal Hat, Dist. Burdwan.	10	PVT	N.HOME	
319	Sebayan Matri Sadan	Kumarpur, Asansol, Burdwan	10	PVT	N.HOME	
320	Seharabazar Nursing Home	Saherbazar, Burdwan	10	PVT	N.HOME	
321	Shree Durga Nursing Home	P-18, Debsen Lane (5th Floor), Flat No. - A-7, Raniganj,	10	PVT	N.HOME	

DISTRICT WISE LIST OF BEDDED HCUs IN WEST BENGAL

INVENTORY: ANNEXURE - I

Sl. No	Name of the Units.	Address	Current Bed	Organisation	Category General	Category Special
322	Shree Krishna Nursing Home	11 Mile, P.O. Boukati, P. S. Kanksha, Burdwan	10	PVT	N.HOME	
323	Sky Lark Nursing Home	Berasat, Dist. Burdwan.	10	PVT	N.HOME	
324	Snow White Nursing Home (P) Ltd.	G.T. Road, Bhiringhi, Durgapur	10	PVT	N.HOME	
325	Star Nursing Home,	Mankar Road, Budbud, Dist. Burdwan.	10	PVT	N.HOME	
326	Subodh Sankar Sebayatan	Krishna Sayer, Dist. Burdwan.	10	PVT	N.HOME	
327	Tejganj Nursing Home	Tejganj, P.O.: Natunganj, Dist. Burdwan.	10	PVT	N.HOME	
328	Ukhra K.P. Nursing Home	Ukhra, Durgapur, Burdwan	10	PVT	N.HOME	
329	Uma Smriti Kalyan Kendra N. Home	Ranisayer (W), Burdwan	10	PVT	N.HOME	
330	Uma Smriti Kalyan Kendra N. Home	Ranisayer (W), Burdwan	10	PVT	N.HOME	
331	Uma Smriti Kalyan Kendra N. Home	Ranisayer (W), Burdwan	10	PVT	N.HOME	
332	Uma Smriti Kalyan Kendra N. Home	Ranisayer (W), Burdwan	10	PVT	N.HOME	
333	Barakar Nursing Home	P.O. Barakar, Dist. Burdwan	9	PVT	N.HOME	
334	Midland Nursing Home	Benachiti, Durgapur, Burdwan	9	PVT	N.HOME	
335	Spandan Nursing Home	347, Bumpur Road, Near Court More, Asansol, Burdwan	9	PVT	N.HOME	
336	Durgapur Nursing Home	Station Road, Durgapur, Burdwan	8	PVT	N.HOME	
337	New Woodland Nursing Home	Ushagram, Asansol, Burdwan	8	PVT	N.HOME	
338	Raghu Nath Nursing Home	G.T. Road, Asansol, Burdwan	8	PVT	N.HOME	
339	Sayani Clinic & Maternity Home	L.C. More, Kulti, Burdwan	7	PVT	N.HOME	
340	Child Clinic & Observation Centre	Hill View Park (E), 79, S. B. Gorai Road, Asansol, Burdwan	6	PVT	N.HOME	
341	Repose Clinic & Nursing Home	G. T. Road (W), Nematpur, P.S.: Kulti, P.O.: Sitarampur,	6	PVT	N.HOME	
342	Debipur Netralaya (Eye Hospital Research Institute)	Vill. Debipore, Dist. Burdwan	5	PVT	N.HOME	EYE
343	Galsi Lions Eye Hospital	Galsi, Puatan Chatty, Burdwan	5	PVT	N.HOME	EYE
344	Kalna Lions Eye Hospital	Bidyabagish Para, Kalna, Burdwan	5	PVT	N.HOME	EYE
345	Lions Seva Eye Hospital	P.O. Jamalpur, Burdwan	5	PVT	N.HOME	EYE
346	A.M. Apollo Nursing Home	Jewdhara (Assam Road), Kalna, Burdwan	5	PVT	N.HOME	
347	Amiya Nursing Home	P.O. & P.S.: Memari, Burdwan	5	PVT	N.HOME	
348	Annapurna Nursing Home	Surudasi Para, Dist. Burdwan.	5	PVT	N.HOME	
349	Ashirbad Nursing Home	Ramkrishna Pally, Main Gate, Durgapur, Burdwan	5	PVT	N.HOME	
350	B.D.N. Seba Sadan	Rani Sayer (S), Dist. Burdwan.	5	PVT	N.HOME	
351	Bankura Seba Niketan	Patpur Jail Road, dist Burdwan	5	PVT	N.HOME	
352	Bimala Nursing Home	Mahishmardini, Kalna, Burdwan	5	PVT	N.HOME	
353	Burdwan Seva Sadan	Ranisayer (S), Burdwan	5	PVT	N.HOME	

DISTRICT WISE LIST OF BEDDED HCUs IN WEST BENGAL

INVENTORY: ANNEXURE - I

Sl. No	Name of the Units.	Address	Current Bed	Organisation	Category General	Category Special
354	Chapala Nursing Home	Paruldanga , Burdwan,	5	PVT	N.HOME	
355	Dr. Niyogi's Surgical Clinic	Bidhannagar, Durgapur, Burdwan	5	PVT	N.HOME	
356	Jagadhatri Nursing Home	Bhatar, Dist. Burdwan.	5	PVT	N.HOME	
357	Memari Maternity Nursing Home	School Para, Memari, Dist. Burdwan.	5	PVT	N.HOME	
358	Menoka Nursing Home	Shaw Sarker More, Kansari Para, Kalna, Burdwan	5	PVT	N.HOME	
359	Nabajiban Nursing Home	Power House Para, Dist. Burdwan.	5	PVT	N.HOME	
360	Paramananada Mission Health Centre	Vill & P.O. Banagram, Dist. Burdwan	5	PVT	N.HOME	
361	Radha Rani Nursing Home	Memari G. T. Road, Burdwan	5	PVT	N.HOME	
362	Rama Nursing Home	Railpore, Panagarh Bazar, Dist. Burdwan	5	PVT	N.HOME	
363	Reliable Medicare Centre Nursing Home	Station Road, P.O. Burnpur, Dist. Burdwan	5	PVT	N.HOME	
364	Samui Nursing Home	Vill. Bulchandrapur, P.O. Paints, Dist. Burdwan	5	PVT	N.HOME	
365	Sanjibani Nursing Home	Jadedra Panja Avenue, Durgapur, Burdwan	5	PVT	N.HOME	
366	Satyanarayan Nursing Home	Vill. & P. O. : Dainhat, Katwa, Burdwan	5	PVT	N.HOME	
367	Shibani Nursing Home	M.N. Raod, Upper Chelidanga, Asansol, Burdwan	5	PVT	N.HOME	
368	Shibani Nursing Home	Thana Road, Durgapur, Burdwan	5	PVT	N.HOME	
369	SIMS Nursing Home & Maternity	150, G.T. Road, Parbihata, Dist. Burdwan	5	PVT	N.HOME	
370	Sri Ram Health Care	Nachan Road, Benachity, Durgapur - 13, Burdwan	5	PVT	N.HOME	
371	Swami Vivekananda Eye Hospital	Gopalpur, P.O.: Asansol, Burdwan	5	PVT	N.HOME	
372	Tarak Nath Arogya Niketan	Kalna, Burdwan	5	PVT	N.HOME	
373	Uma Smriti Kalyan Kendra N. Home	Ranisayer (W), Burdwan	5	PVT	N.HOME	
374	Uma Smriti Kalyan Kendra N. Home	Ranisayer (W), Burdwan	5	PVT	N.HOME	
375	Vivek Clinic & Nursing Home	Dr. B. C. Roy Avenue, Durgapur-1, Burdwan	5	PVT	N.HOME	
376	A Family Welfare, Child Health & Eye Hospital	Katwa, Burdwan	4	PVT	N.HOME	
377	Burdwan Poly Clinic Nursing Home	Pallika Bazar, G.T. Road, Dist. Burdwan.	4	PVT	N.HOME	
378	Care Nursing Home	Rambagan, P.O. Searsole Rajbari, Dist. Burdwan	4	PVT	N.HOME	
379	Memari Matri Sadan	Dr. Jayashree Kanan Memory Hospital Road, Memari,	4	PVT	N.HOME	
380	West Land Nursing Home (Bulu Bandyopadhyay)	Aldrin Path, Bidhannagar, Durgapur, Burdwan	4	PVT	N.HOME	
381	Amala Arogya Niketan & Poly Clinic	Vill & P.O. Rupnarayanpur, Dist. Burdwan	3	PVT	N.HOME	
382	Burdwan Diagnostic & Research Centre (P) Ltd.	G.T. Road (Badamtala), P.O. & Dist. Burdwan	3	PVT	N.HOME	
383	G.K. Nursing Home	Sahid Kshudiram Sarani, Durgapur, Burdwan	3	PVT	N.HOME	
384	Matri Seva Clinic	Star Chember, Kendua, Bazar, P.O. Kulti, Dist - Burdwan	3	PVT	N.HOME	
385	West Land Nursing Home (Dr. A. B. Mondal)	Sadhudanga, Durgapur-I, Burdwan	3	PVT	N.HOME	
		TOTAL NUMBER OF BEDS IN BURDWAN DISTRICT:	9910			

DISTRICT WISE LIST OF BEDDED HCUs IN WEST BENGAL

INVENTORY: ANNEXURE - I

Sl. No	Name of the Units.	Address	Current Bed	Organisation	Category General	Category Special
COOCHBEHAR						
1	M.J.N. Hospital – Coochbehar	P.O. Coochbehar, Coochbehar – 736 101	400	GOVT	DH	
2	S. D. Hospital – Dinhata, Coochbehar	P.O. Dinhata, Coochbehar – 736 135	180	GOVT	SD	
3	S.D. Hospital – Mathabhanga	P.O. Mathabhanga, Coochbehar – 736 146	120	GOVT	SD	
4	S.D. Hospital – Mekhligunge	P.O. & P.S. Mekhligunge, Dist. Coochbehar, PIN. 735304	120	GOVT	SD	
5	S.D. Hospital – Tufangunge	Tufangunge, Coochbehar – 736 159	100	GOVT	SD	
6	J.D. Hospital (SGH)	P. O. : - Mahishbathan, Coochbegar	120	GOVT	SGH	
7	Haldibari Rural Hospital	Haldibari (M), Haldibari, Coochbehar	30	GOVT	RH	
8	Bamanhat BPHC	Bamanhat, Dinhata – II, Coochbehar	15	GOVT	BPHC	
9	Sitai BPHC	PO.Sitaihat, Dist.Coochbehar, PIN - 736167	15	GOVT	BPHC	
10	Sitalkuchi BPHC	Vill, PO. & PS.Sitalkuchi, Dist.Coochbehar	15	GOVT	BPHC	
11	Baxirhat BPHC	Baxirhat, Tufanganj – 1, Coochbehar	10	GOVT	BPHC	
12	Changrabandha BPHC	Changrabandha, Mekhliganj, Coochbehar	10	GOVT	BPHC	
13	Dewanhat BPHC	Coochbehar – 1, Dewanhat	10	GOVT	BPHC	
14	Ghhoksardanga BPHC	Goksardanga, Mathabhanga - II, Coochbehar	10	GOVT	BPHC	
15	Gosanimari BPHC	Gosanimari, Dinhata, Coochbehar	10	GOVT	BPHC	
16	Natabari BPHC	Natabari, Tufanganj – I, Coochbehar	10	GOVT	BPHC	
17	Pundibari BPHC	Coochbehar – II, Pundibari	10	GOVT	BPHC	
18	Khetifulbari PHC	Fulbari, Mathabhanga - II, Coochbehar	10	GOVT	PHC	
19	Nishiganj PHC	Nishiganj, Sitalkuchi, Coochbehar	10	GOVT	PHC	
20	Putimari Phuleswari PHC	Coochbehar - , Patpushu	10	GOVT	PHC	
21	Rampur PHC	Rampur, Tufanganj – 1, Coochbehar	10	GOVT	PHC	
22	Angarkata PHC	Paradubi, Mathabhanga - II, Coochbehar	6	GOVT	PHC	
23	Chilkarhat PHC	Coochbehar – 1, Chilkarhat	6	GOVT	PHC	
24	Chotasalbari PHC	Chotasalbari, Sitalkuchi, Coochbehar	6	GOVT	PHC	
25	Hudumdanga PHC	Dewanganj, Haldibari, Coochbehar	6	GOVT	PHC	
26	Jamaldaha PHC	Jamaldaha, Mekhliganj, Coochbehar	6	GOVT	PHC	
27	Kuchibari PHC	Kuchibari, Haldibari, Coochbehar	6	GOVT	PHC	
28	Najirhat PHC	Najirhat, Dinhata, Coochbehar	6	GOVT	PHC	
29	Nayerhat PHC	Nayerhat, Dinhata, Coochbehar	6	GOVT	PHC	
30	Okrabari PHC	Okrabari, Dinhata, Coochbehar	6	GOVT	PHC	
31	Pakhihaga PHC	Mathabhanga - 1, Mathabhanga, Coochbehar	6	GOVT	PHC	

DISTRICT WISE LIST OF BEDDED HCUs IN WEST BENGAL

INVENTORY: ANNEXURE - I

Sl. No	Name of the Units.	Address	Current Bed	Organisation	Category General	Category Special
32	Patlakhawa PHC	Coochbehar – II, Patlakhawa	6	GOVT	PHC	
33	Adabari PHC	Sitai, Kisamat-Adabari, Coochbehar	4	GOVT	PHC	
34	Balarampur PHC	Balrampur, Tufanganj – 1, Coochbehar	4	GOVT	PHC	
35	Bokalirmath PHC	Coochbehar – II, Bokalirmath PHC	4	GOVT	PHC	
36	Dewchari PHC	Dewchari, Tufanganj – 1, Coochbehar	4	GOVT	PHC	
37	Gopalpur PHC	Coochbehar – II, Gopalpur	4	GOVT	PHC	
38	Jatamari PHC	Jatamari, Sitalkuchi, Coochbehar	4	GOVT	PHC	
39	Kalijani PHC	Coochbehar – II, Kalijani	4	GOVT	PHC	
40	Kisamath (Dasgram) PHC	Kisamath (Dasgram), Dinhata, Coochbehar	4	GOVT	PHC	
41	Moradanga PHC	Moradanga, Tufanganj – 1, Coochbehar	4	GOVT	PHC	
42	Nakarjan PHC	Sitai, Nakarjan, Dinhata, Coochbehar	4	GOVT	PHC	
43	Panaguri PHC	Mathabhanga - I, Shibpur, coochbehar	4	GOVT	PHC	
44	Salbani PHC	Salbani, Tufanganj – 1, coochbehar	4	GOVT	PHC	
45	Angu.dekha PHC	Bakshirganj, Haldibari, coochbehar	2	GOVT	PHC	
46	Tharaikhana PHC	Tharaikhana, Dinhata. Coochbeha	2	GOVT	PHC	
47	Coochbehar Jail Hospital (SGJ)	Coochbehar – (M), Coochbehar	20	GOVT	SGJ	
48	Coochbehar Police Hospital	Coochbehar (M), Coochbehar	20	GOVT	SGP	
49	New Coochbehar Rly Hospital (RLY)	Coochbehar – II (B), New Coochbehar	2	GOVT	RLY	
50	Cooch Bhehar Mission Hospital (P) Ltd.	P.O. Chakchaka, P.S. : Kotowali, Dist. Cooch Behar, PIN- 736156	100	PVT	N.HOME	
51	Shila Nursing Home	Bairagi Dighi Bye Lane, P.S.: Kotowali, P.O. & Dist.: Coochbehar	60	PVT	N.HOME	
52	Subham Hospital & Diagnostic Center Pvt. Ltd.	Narayan Road, P. O. Coochbehar	50	PVT	N.HOME	
53	Poddar Seva Sadan Pvt. Ltd.	Seunity Road – Bye Lane, P.O. & Dist: Coochbehar	45	PVT	N.HOME	
54	Astha Seva Sadan	Netaji Road, Ward no. 4, Dinhata, Coochbehar	30	PVT	N.HOME	
55	Maharaja Nursing Home (P) Ltd.	Siliguri Road, (Khagrabari), P.O. & Dist.: Coochbehar	30	PVT	N.HOME	
56	Shila Nursing Home	Bairagi Dighi Bye Lane, Coochbehar	30	PVT	N.HOME	
57	Prosantinetrailayam Pvt. Ltd.	Dakshin Khagrabari, Siliguri Road, P.O. & Dist. Coochbehar	25	PVT	N.HOME	
58	Dinhata Nursing Home	Madan Mohan Para, P.O. & P.S.: Dinhata, Ward No. 2, Coochbehar	20	PVT	N.HOME	
59	Jeeban Deep Nursing Home	Magazine Road, Coochbehar	20	PVT	N.HOME	
60	Joy Lakshmi Nursing Home	N.N. Road Bye Lane, Coochbehar	20	PVT	N.HOME	
61	Regional Cancer Centre	Binapatty, P.S.; Kotwali, P.O. & Dist: Coochbehar	15	PVT	N.HOME	CAN
62	Metropolitan Nursing Home	Hospital Road, Coochbehar	13	PVT	N.HOME	
63	Coochbehar Eye Care & Research Centre Pvt. Ltd.,	R.R.N. Road, Coochbehar	10	PVT	N.HOME	EYE

DISTRICT WISE LIST OF BEDDED HCUs IN WEST BENGAL

INVENTORY: ANNEXURE - I

Sl. No	Name of the Units.	Address	Current Bed	Organisation	Category General	Category Special
64	Arogya Niketan	Hospital Road, P.O. & P.S.: Mathabangha, Coochbehar	10	PVT	N.HOME	
65	Joy Guru Nursing Home	Bangchatra Road, Gariahati, P.O. & Dist. Coochbehar	10	PVT	N.HOME	
66	Marina Nursing Home	Madan Mohan Para, Dinjata, Coochbehar	10	PVT	N.HOME	
67	Mili Nursing Home	Deshbandhu Para, Hospital Road, Mathabangha, Coochbehar	10	PVT	N.HOME	
68	Roy Nursing Home	B.D.O. Office Road, P.O. & P.S.: Tufanganj, Coochbehar	10	PVT	N.HOME	
69	Tufangunge Nursing Home	Prannatah Iswar Road, Lambapara, Tufangunge, Coochbehar	5	PVT	N.HOME	
70	Universal Progressive Study & Cultural Forum (Ophthalmic Care &	Khagabari, (Near S.B.I.), Coochbehar	5	PVT	N.HOME	
71	Sree Maa Nursing Home Pvt. Ltd.	Priyanath Babu Road, Coochbehar	3	PVT	N.HOME	
		TOTAL NUMBER OF BEDS IN COOCHBEHAR DISTRICT:	1916			
DAKSHIN DINAJPUR						
1	Dist. Hospital Dakshin Dinajpur - Balurghat	P.O. Beltalpark, Balurghat, Dakshin Dinajpur	300	GOVT	DH	
2	S. D. Hospital – Gangarampur	Gangarampur, Dakshin Dinajpur	120	GOVT	SD	
3	Hili Rural Hospital	Hili, P.O. Hili, Dakshin Dinajpur	25	GOVT	RH	
4	Kushmandi BPHC	Kushmandi, Dakshin Dinajpur	30	GOVT	BPHC	
5	Rashidpur BPHC	Rashidpur, Dakshin Dinajpur	20	GOVT	BPHC	
6	Harirampur BPHC	P.O. Harirampur, Dakshin Dinajpur	15	GOVT	BPHC	
7	Khaspur BPHC	Balurghat, P.O. Khaspur, Dakshin Dinajpur	15	GOVT	BPHC	
8	Kumarganj BPHC	Kumarganj, Dakshin Dinajpur	15	GOVT	BPHC	
9	Tapan BPHC	Tapan, Dakshin Dinajpur	15	GOVT	BPHC	
10	Samjia PHC	Kumarganj, P.O. Penitora, Dakshin Dinajpur	10	GOVT	PHC	
11	Bolla PHC	Balurghat, P.O. Bolla, Dakshin Dinajpur	6	GOVT	PHC	
12	Dakra PHC	Balurghat, P.O. Chakbhriga, Dakshin Dinajpur	6	GOVT	PHC	
13	Kamarpara PHC	Balurghat, P.O. Kamarpara, Dakshin Dinajpur	6	GOVT	PHC	
14	Rampara (Chichra) PHC	Tapan, P.O. Chichra, Dakshin Dinajpur	6	GOVT	PHC	
15	Rashidpur PHC	Harirampur, P.O. Bansihari, Dakshin Dinajpur	6	GOVT	PHC	
16	Bathun PHC	Kumarganj, P.O. Bathun, Dakshin Dinajpur	4	GOVT	PHC	
17	Bharandah (Boalder) PHC	Balurghat, P.O. Bara Kasipur	4	GOVT	PHC	
18	Binsira PHC	Hilli, P.O. Tear, Dakshin Dinajpur	4	GOVT	PHC	
19	Mathurapur (Chalon) PHC	Gangarampur, P.O. Bansagar, Dakshin Dinajpur	4	GOVT	PHC	
20	Monahali PHC	Tapan, P.O. Monahali, Dakshin Dinajpur	4	GOVT	PHC	
21	Nazipur PHC	Balurghat, P.O. Nazipur Dakshin Dinajpur	4	GOVT	PHC	
22	Sarbamangala (Bansuria) PHC	Gangarampur, P.O. Sarbamangala, Dakshin Dinajpur	4	GOVT	PHC	

DISTRICT WISE LIST OF BEDDED HCUs IN WEST BENGAL

INVENTORY: ANNEXURE - I

Sl. No	Name of the Units.	Address	Current Bed	Organisation	Category General	Category Special
23	Aminpur PHC	Kushmandi, P.O. Aminpur, Dakshin Dinajpur	2	GOVT	PHC	
24	Badalpur PHC	Harirampur, P.O. Badalpur, Dakshin Dinajpur	2	GOVT	PHC	
25	Deon PHC	Kumarganj, P.O. Deor, Dakshin Dinajpur	2	GOVT	PHC	
26	Malancha PHC	Tapan, P.O. Balapur, Dakshin Dinajpur	2	GOVT	PHC	
27	Nonaharpara PHC	Kushmandi, P.O. Sehal, Dakshin Dinajpur	2	GOVT	PHC	
28	Trimohini PHC	Hilli, P.O. Trimohini, Dakshin Dinajpur	2	GOVT	PHC	
29	Matri Sadan Cum O.P.D. (Balurghat Municipality)	Balurghat, South Dinajpur	30	GOVT	MUNI	MNTY
30	Balurghat Police Hospital	Balurghat, Dakshin Dinajpur	50	GOVT	SGP	
31	Holy Cross Hospital	Gangarampur, Dakshin Dinajpur	25	PVT	N.HOME	
32	Sandhya Nursing Home & Diagnostic Centre	Subhas Pally, B.B.D. More, P.O. & P.S. Gangarampur, D. Dinajpur	25	PVT	N.HOME	
33	Prayash Atreyee	Raghunathpur, P.O.: Beltalpark, P.S.: Balurghat, Dakshin Dinajpur	18	PVT	N.HOME	
34	Majumdar Nursing Home	Raghunathpur, B. T. Park, Balurghat, Dakshin Dinajpur	15	PVT	N.HOME	
35	Basanti Seva Kendra	North Chakhabani, Balurghat, Dakshin Dinajpur	10	PVT	N.HOME	
36	Jeevan Jyoti Nursing Home	Vill. & P.O. Kaldighi, P.S. Gangarampur, Dist. D. Dinajpur	10	PVT	N.HOME	
37	Punorbhaba Nursing Home	Kaldighi, Gangarampur, Dakshin Dinajpur	3	PVT	N.HOME	
		TOTAL NUMBER OF BEDS IN DAKSHIN DINAJPUR DISTRICT:	821			
DARJEELING						
1	North Bengal Medical College & Hospital	Sushrutanagar, Darjeeling	1000	GOVT	MCH	
2	Siliguri District Hospital	P.O. Siliguri, Darjeeling	320	GOVT	DH	
3	District Hospital – Darjeeling	Dr. Yen Singh Road, Dist. Darjeeling, PIN - 734101	308	GOVT	DH	
4	S.D. Hospital – Kalimpong	Kalimpong, Darjeeling – 734 301	370	GOVT	SD	
5	S.D. Hospital – Kurseong	P.O. Kurseong, Darjeeling - 734203	100	GOVT	SD	
6	Darjeeling T.B. Hospital	Darjeeling (M), Dist. Darjeeling	50	GOVT	SGH	TB
7	Naxalbari Rural Hospital	P.O. Naxalbari, Dist. Darjeeling	50	GOVT	RH	
8	Bijanbari Rural Hospital	Darjeeling – Pulbazar, P.O. Bijanbari, Dist. Darjeeling,	30	GOVT	RH	
9	Kharibari Rural Hospital	Kharibari, P.O. Kharibari, Dist. Darjeeling	30	GOVT	RH	
10	Gorubathan BPHC	Gorubathan, P.O. Gagu, Dist. Darjeeling	25	GOVT	BPHC	
11	Pedong BPHC	Kalimpong – II, P.O. Pedong, Dist. Darjeeling	25	GOVT	BPHC	
12	Sukhiapokhri BPHC	Jorebunglow-Sukhiapokhri, P.O.. Sukiapokhri, Dist. Darjeeling	25	GOVT	BPHC	
13	Takdah BPHC	Rangali – Rangliot, P.O. Takdah, Dist. Darjeeling	25	GOVT	BPHC	
14	Mirik BPHC	Mirik, P.O. Mirik, Dist. Darjeeling	15	GOVT	BPHC	
15	Sukna BPHC	Kurseong, P.O. Sukna, Dist. Darjeeling	15	GOVT	BPHC	

DISTRICT WISE LIST OF BEDDED HCUs IN WEST BENGAL

INVENTORY: ANNEXURE - I

Sl. No	Name of the Units.	Address	Current Bed	Organisation	Category General	Category Special
16	Phansidewa BPHC	Kharibari, P.O. Phansidewa, Dist. Darjeeling	10	GOVT	BPHC	
17	Rambi BPHC	Kalimpong – 1, P.O. Rambibazar, Dist. Darjeeling	10	GOVT	BPHC	
18	Bagdogra PHC	Siliguri – Naxalbari, P.O. Bagdogra, Dist. Darjeeling	10	GOVT	PHC	
19	Matigara PHC	Siliguri – Naxalbari, P.O. Matigara, Dist. Darjeeling	10	GOVT	PHC	
20	SonadaPHC	Jorebunglow- Sukiapokhri. P.O. Sonada, Dist. Darjeeling	8	GOVT	PHC	
21	Baggoura PHC	Kurseong, P.O. Bagora, Dist. Darjeeling	6	GOVT	PHC	
22	Bidhannagar PHC	Kharibari, P.O. Bidhannagar, Dist. Darjeeling	6	GOVT	PHC	
23	Ghoom PHC	Jorebunglow-Sukhiapokhri, P.O. Ghoom, Dist. Darjeeling	6	GOVT	PHC	
24	Gitdubling PHC	Kalimpong –II, P.O. Gitdubling, Dist. Darjeeling	6	GOVT	PHC	
25	Lodhamma PHC	Darjeeling – Pulbazar, P.O. Lodhama, Dist. Darjeeling	6	GOVT	PHC	
26	Rangali PHC	Kharibari, P.O. Naxalbari, Dist. Darjeeling	6	GOVT	PHC	
27	Samthar Samalbng PHC	Kalimpong – 1, P.O. Samthar, Dist. Darjeeling	6	GOVT	PHC	
28	Singringtom PHC	Rangli – Rangliot, P.O. Singringtom, Dist. Darjeeling	6	GOVT	PHC	
29	Teesta Bazar PHC	Kalimpong – 1, P.O. Teesta Bazar, Dist. Darjeeling	6	GOVT	PHC	
30	Ghayabari PHC	Ghayabari, Kurseong, Darjeeling	4	GOVT	PHC	
31	Jaldakha PHC	Gorubathan, P.O. Jaldakha Hydell Project, Dist. Darjeeling	4	GOVT	PHC	
32	Sittang PHC	Kurseong, P.O. Bagora, Dist. Darjeeling	4	GOVT	PHC	
33	Takling PHC	Rangli – Rangliot, P.O. Tista Bridge, Dist. Darjeeling	4	GOVT	PHC	
34	Algarh PHC	Kalimpong – II, P.O. Algarh, Dist. Darjeeling	2	GOVT	PHC	
35	Duptin PHC	Mirik, P.O. Mirik, Dist. Darjeeling	2	GOVT	PHC	
36	Pokhriabong PHC	Jorebunglow-Sukhiapokhri, P.O. Sukhiapokhri, Dist. Darjeeling	2	GOVT	PHC	
37	Sherpagaon PHC	Gorubathan, P.O. Shirpagaon, Dist. Darjeeling	2	GOVT	PHC	
38	Sourani Bastee PHC	Mirik, P.O. Mirik, Dist. Darjeeling	2	GOVT	PHC	
39	Mansong Cinchona Plantation Hospital	Kalimpong (B), Mansong, Dist. Darjeeling	16	GOVT	SGCI	
40	Medicinal Plantation Hospital Mongpoo	Takdah (B), Mangpoo, Dist. Darjeeling	16	GOVT	SGCI	
41	Latpanchar Cinchona Plantation Hospital	Kurseong (M), Latpanchar, Dist. Darjeeling	12	GOVT	SGCI	
42	Medicinal Plantation Hospital.. Rangoo	Gorubathan (B), Rangoo, Dist. Darjeeling	11	GOVT	SGCI	
43	Dowhill Central Hospital	Kurseong (M), Kurseong, Dist. Darjeeling	40	GOVT	SGE	
44	Tindharia Rly. Hospital (N. F. Railway)	Kurseong (M), Tindharia, Dist. Darjeeling	20	GOVT	RLY	
45	Siliguri Junction Railway Health Unit	Siliguri, Darjeeling	2	GOVT	RLY	
46	Darjeeling Jail Hospital,	Darjeeling (M), Dist. Darjeeling	12	GOVT	SGJ	
47	Special Jail Hospital	Siliguri (MC), Siliguri, Dist. Darjeeling	12	GOVT	SGJ	

DISTRICT WISE LIST OF BEDDED HCUs IN WEST BENGAL

INVENTORY: ANNEXURE - I

Sl. No	Name of the Units.	Address	Current Bed	Organisation	Category General	Category Special
48	Police Hospital Kadamtala,	Siliguri (MC), Siliguri, Dist. Darjeeling	50	GOVT	SGP	
49	Darjeeling I.D. Hospital	Darjeeling (M), Dist. Darjeeling	24	GOVT	MUNI	ID
50	IPP - VIII Maternity Home	Debogram, Siliguri, Darjeeling	17	GOVT	MUNI	MNTY
51	S.B. Dey T.B. Sanatorium	Kurseong (M), Kurseong, Dist. Darjeeling	334	GOVT	SANT	TB
52	Dr. Chang's Super Speciality Hospital (P) Ltd.	Himachal Vihar, Phase - III, P.O.: Matigara, P.S.: Matigara, Darjeeling	200	PVT	N.HOME	
53	North Bengal Clinic Pvt. Ltd.,	Pradhan Nagar, Siliguri, Dist. Darjeeling	100	PVT	N.HOME	
54	Anandalok Hospital & Neurosciences Centre	2nd Mile, Sevok Road, Siliguri, Darjeeling	70	PVT	N.HOME	
55	Paramount Hospital Pvt. Ltd.	Mangal Pandey Road, Siliguri, PIN - 734005	70	PVT	N.HOME	
56	Mitra's Clinic & Nursing Home	Hakimpara, Siliguri, Darjeeling	60	PVT	N.HOME	
57	Maternity and Nursing Home	Tilak Road, Hakimpara, Siliguri, Darjeeling	50	PVT	N.HOME	
58	Navajeevan Hospital & Rural Health Care Center	Gaya Ganga, P. O. Kamala Bagan, Darjeeling	50	PVT	N.HOME	
59	Doors & Darjeeling Nursing Home	7, Nehuru Road, Darjeeling	48	PVT	N.HOME	
60	Siliguri Lions Netralaya	Cooliapara, Mahananda Bridge, Siliguri	43	PVT	N.HOME	EYE
61	Arogya Niketan Nursing Home cum Maternity Home	S.P. Mukherjee Road, Khalpara, Siliguri, Darjeeling	40	PVT	N.HOME	
62	Matri Sangha Janakalya Ashram	1, Balaidas Chatterjee Road, Hakimpara, Siliguri, Darjeeling	40	PVT	N.HOME	
63	Ramkrishan Nursing Home	Nazrul Sarani, Ashrampara, Darjeeling	40	PVT	N.HOME	
64	Basu's Clinic,	Nandalal Basu Sarani, College Para, Siliguri, Darjeeling	34	PVT	N.HOME	
65	Bhogibita Hospital	Kharibari, Phansidewa, Kalambazar, Darjeeling	32	PVT	N.HOME	
66	Ashirwad Medical Centre	C-2, Ganpati Apartment, Vidyasagar Road, Khalpara, Siliguri, Darjeeling	30	PVT	N.HOME	
67	B. B. S. Astha Unit of Madan Ganga Nursing Home	West Ashrampara, Siliguri, Darjeeling	30	PVT	N.HOME	
68	Daw D. M. A. Planner Hospital	7, Nehuru Road, Darjeeling	30	PVT	N.HOME	
69	Dr. Nayak's Nursing Home Pvt. Ltd.,	2nd Mile, Sevoke Road, Siliguri, Darjeeling	30	PVT	N.HOME	
70	North Bengal Neuro Research Centre Pvt. Ltd	Pradhannagar, Siliguri, Darjeeling	30	PVT	N.HOME	
71	Siliguri Greater Lions Eye Hospital,	2nd Mile, Sevoke Road, Siliguri, Darjeeling	30	PVT	N.HOME	EYE
72	Siliguri Nursing Home Pvt. Ltd.	Haren Mukherjee Road, Hakimpara, Siliguri, Darjeeling	30	PVT	N.HOME	
73	Sunrise Nursing Home Pvt. Ltd.	Udham Singh Sarani, Sevok Road, Ashrampara, Siliguri, Darjeeling	30	PVT	N.HOME	
74	Yuma Nursing Home	7A, Ballen Villa Road, Darjeeling	30	PVT	N.HOME	
75	Dr. Malays Hospital & Neurosciences Center	Station Feeder Rd, P.O.: Siliguri Bazar, Darjeeling	25	PVT	N.HOME	
76	Mitra's Speciality Clinic	Tilak Road, Hakimpara, Siliguri, Darjeeling	24	PVT	N.HOME	
77	Ambika Chikitsalay & Matri Sadan Nursing Home	29, Agram Road, Khalpara, Siliguri, Darjeeling	20	PVT	N.HOME	
78	Dr. Graham's	Kalimpong, Darjeeling	20	PVT	N.HOME	
79	Dr. K.N. Chatterjee Memorial Nursing Home,	Hill Cart Road, Siliguri, Darjeeling	20	PVT	N.HOME	

DISTRICT WISE LIST OF BEDDED HCUs IN WEST BENGAL

INVENTORY: ANNEXURE - I

Sl. No	Name of the Units.	Address	Current Bed	Organisation	Category General	Category Special
80	Dr. Mallick's Nursing Home	10th Mile, Kalimpong, Darjeeling	20	PVT	N.HOME	
81	Marium Nursing Home	N. B. Singha Road, Darjeeling	20	PVT	N.HOME	
82	Nivedita Nursing & Poly Clinic Pvt. Clinic Ltd	Pradhan Nagar, Siliguri, Darjeeling	20	PVT	N.HOME	
83	Ramkrishna Seva Sadan Nursing Home	Bidhan Road, Siliguri, Dist. Darjeeling	20	PVT	N.HOME	
84	Shanti Swasthalaya & Anusandhan Kendra Pvt. Ltd.,	Basipaul Coloni, Mahanandapara, Siliguri, Darjeeling	20	PVT	N.HOME	
85	Adarsha Nursing Home	Sahid D. Giri Road, Kalimpong, Darjeeling	19	PVT	N.HOME	
86	Dr. Mohopal Orthopedic and Physiotherapy Center	Meghnad Saha Sarani, Pradhan Nagar, Siliguri, Darjeeling	19	PVT	N.HOME	
87	Hill Point Clinic Laproscopic Surgery & Nursing Home Medicare Pvt.	Pradhan Nagar, Mallaguri, Siliguri, Darjeeling	19	PVT	N.HOME	
88	Matri Sadan Nursing Home,	Station Feeder Rd, Behind Urbashi Cinema Hall, Siliguri, Darjeeling	15	PVT	N.HOME	
89	Sebayan Drug De-Addiction Center	Ramkrishnapara, P.O.: Matigara, Darjeeling, PIN>: 734010	15	PVT	N.HOME	
90	North Bengal Eye Center (P) Ltd.	Udham Singh Sarani, Ashram Para, Siliguri,	14	PVT	N.HOME	EYE
91	Ashray Health Care & Research Centre Pvt. Ltd.	Sarkar Bhavan, 20, Champasari Bazar, Siliguri, Darjeeling	10	PVT	N.HOME	
92	Dr. Pijushkanti Roy Maternity & Nursing Home	Hakimpara, Siliguri, Darjeeling	10	PVT	N.HOME	
93	Kalimpong Clinic	18th Miles, Kalimpong, Darjeeling	10	PVT	N.HOME	
94	Maya Sanyal Clinic & Nursing Home	Sajan Villa, Nazrul Sarani, Ashrampara, Siliguri, Darjeeling	10	PVT	N.HOME	
95	North Bengal Oncology Center (P) Ltd.	21, Nivedita Road, P.O.: Pradhan Nagar, Siliguri, Darjeeling	10	PVT	N.HOME	CAN
96	Roy Polyclinic cum Nursing Home	P.O. & P.S.: Khoribari, Darjeeling	10	PVT	N.HOME	
97	Sebasadan Hospital	Kalimpong (M), Kalimpong, Dist. Darjeeling	10	PVT	N.HOME	
98	Seva Sadan Hospital	10th Mile, P.O.: Kalimpong, Darjeeling	10	PVT	N.HOME	
99	Surgery & Urology Clinic	Hakimpara, Siliguri, Darjeeling	10	PVT	N.HOME	
100	Kejriwal's Stone Clinic	Pranami Mandir Road, Siliguri, Darjeeling	9	PVT	N.HOME	
101	Shaibal Nursing Home	Bidhan Market, Siliguri, Darjeeling	9	PVT	N.HOME	
102	Durgapada Memorial Nursing Home	Rajani Bagan, Hilcart Road, P.O.: Siliguri, Darjeeling	8	PVT	N.HOME	
103	Jamgon Kongtrul Eye Centre	8th Mile, Lower Bridle Road, P.O. & P.S.: Kalimpong, Darjeeling	8	PVT	N.HOME	EYE
104	Ramkrishna Seba Sadan	Siliguri – Naxalbari (B), Naxalbari, Dist. Darjeeling	8	PVT	N.HOME	
105	Riddhi Maternity Clinic cum Nursing Home	Netaji Sarni, P.O. Haiderpara, Siliguri	8	PVT	N.HOME	
106	Bengal Kidney Center	Meghnad Saha Sarani, Pradhan Nagar, Siliguri, Darjeeling	6	PVT	N.HOME	
107	Dinchhen Sherap Chhocling Charitable Hospital	Shatni Chowk, Mungpoo, Darjeeling	5	PVT	N.HOME	
108	I.S.B. Memoiral Eye Clinic	Charch Road, Siliguri, Darjeeling	5	PVT	N.HOME	
109	Mother Cure Nursing Home,	Hakimpara, Siliguri, Darjeeling	5	PVT	N.HOME	
110	Mother's Clinic	23, Ashutosh Mukherjee Road, ground floor, Collage Rd, Siliguri	5	PVT	N.HOME	
111	Park Side Clinic	Bagha Jatin Park, Siliguri, Darjeeling	5	PVT	N.HOME	
112	Seba Polyclinic Cum Nursing Home	Purba Saradapally, P.O.: Kadamtala, P.S.: Matigara, Darjeeling	5	PVT	N.HOME	

DISTRICT WISE LIST OF BEDDED HCUs IN WEST BENGAL

INVENTORY: ANNEXURE - I

Sl. No	Name of the Units.	Address	Current Bed	Organisation	Category General	Category Special
113	Shri Ram Krishna Seva Sadan Nursing Home	Siliguri, Darjeeling	5	PVT	N.HOME	
114	Mallick Nursing Home	101/2 Mile Rish Road, P.O.: Kalimpong, Darjeeling	3	PVT	N.HOME	
115	Ugen Mindrol Samtenling Clinic	Gompa Dara, P.O.: Gitdabing, P.S.: Kalimpong, Darjeeling	3	PVT	N.HOME	
116	Matidhar & Nijlmoni Tea Estate Hospital	Kamalbagan, Dist. Darjeeling	10	PVT	TEA EST.	
117	Thanjhora Tea Estate Hospital	Thanjhorabagan, Dist. Darjeeling	10	PVT	TEA EST.	
118	Sukna Tea Estate Hospital	Gulma, Dist. Darjeeling	9	PVT	TEA EST.	
119	Merry View Tea Estate Hospital	Hatighisa, Dist. Darjeeling	8	PVT	TEA EST.	
120	Ashapur Tea Estate Hospital	Naxalbari (B), Naxalbari, Dist. Darjeeling	5	PVT	TEA EST.	
121	Fulbari Tea Estate Hospital	Naxalbari, Dist. Darjeeling	5	PVT	TEA EST.	
122	Manjha Tea Estate Hospital	Belgachi, Dist. Darjeeling	5	PVT	TEA EST.	
123	Satischandra Tea Estate Hospital	Naxalbari, Dist. Darjeeling	5	PVT	TEA EST.	
124	Chandmoni Tea Estate Hospital	Naxalbari (B), Naxalbari, Dist. Darjeeling	4	PVT	TEA EST.	
125	Naxalbari Tea Estate Hospital	Naxalbari, Dist. Darjeeling	4	PVT	TEA EST.	
126	Sayadabad Tea Estate Hospital	Kamalbagan, Dist. Darjeeling	4	PVT	TEA EST.	
127	Dagapur Tea Estate Hospital	Naxalbari (B), Naxalbari, Dist. Darjeeling	2	PVT	TEA EST.	
128	Mission Hill Tea Estate Hospital	Fagu, Dist. Darjeeling	2	PVT	TEA EST.	
129	Fulbari-Patan Tea Estate Hospital	Siulibari, Dist. Darjeeling	1	PVT	TEA EST.	
		TOTAL NUMBER OF BEDS IN DARJEELING DISTRICT:	4800			
E. MIDNAPORE						
1	Purba Medinipore Dist. Hospital	Tamluk, Medinipore(E)	336	GOVT	DH	
2	S. D. Hospital – Contai	Contai, Medinipore (E)	131	GOVT	SD	
3	S. D. Hospital – Haldia	Basudebpur, Khanjanchak, Haldia, Medinipore (E)	100	GOVT	SD	
4	S. D. Hospital – Egra	Egra, Medinipur (E)	68	GOVT	SD	
5	Digha State General Hospital	Ramnagar –1, Digha, Medinipore (E)	50	GOVT	SG	
6	Purba Dakshin Moyna Sri Binoy Krishna Social Welfare Society	Vill. & P.O. & P.S.: Moyna, Purba Medinipore	6	GOVT	SGH	
7	Sohagi Haldia Heematology Thalasceamia Care Prevention &	Vill. & P.O.: Chaitanyapur, P.S.: Sutahata, Purba Medinipore	4	GOVT	SGH	
8	Basulia Rural Hospital	Mahisadal – II, Basulia, Medinipur (E)	30	GOVT	RH	
9	Bhagwanpur Rural Hospital	Bhagwanpur – I, Medinipore	30	GOVT	RH	
10	Reapara Rural Hospital	Nandigram – II, Reapara, Medinipur (E)	25	GOVT	RH	
11	Khejurberia BPHC	Mahisadal – I, Vill.Khejurberia, P.O. & P.S. Nandakumar, Medinipur (E)	30	GOVT	BPHC	
12	Patashpur BPHC	Patashpur – I, Medinipore (E)	20	GOVT	BPHC	
13	Barabantalia BPHC	Vill. & P.O. Barabantalia, Contai – II, Dist. Medinipur (E)	15	GOVT	BPHC	

DISTRICT WISE LIST OF BEDDED HCUs IN WEST BENGAL

INVENTORY: ANNEXURE - I

Sl. No	Name of the Units.	Address	Current Bed	Organisation	Category General	Category Special
14	Bararankua (Kaviraj U.N. Dey) BPHC	Ramnagar – II, Balisani, Medinipur (E)	15	GOVT	BPHC	
15	Digha (Aghorkamini) BPHC	Ramnagar – I, P.O. & P.S. Digha, Dist. Medinipur (E)	15	GOVT	BPHC	
16	Gar Mayna BPHC	Mayna, Medinipur (E)	15	GOVT	BPHC	
17	Kamarda BPHC	P.O. Kamarda Bazar, P.S. Khejuri, Kalagachia, Dist. Medinipore (E)	15	GOVT	BPHC	
18	Nandigram BPHC	Nandigram – I, Nandigram, Medinipur (E)	15	GOVT	BPHC	
19	Paikpari BPHC	Panskura – II, Kolaghat, Medinipur	15	GOVT	BPHC	
20	Uttar Mechogram BPHC	Vill. & P.O. Uttar Mechogram, P.S. Panskura, Keshpat, Medinipur (E)	15	GOVT	BPHC	
21	Majna BPHC	P.O. Majna, P.S. Contai, Dist. Medinipur (E)	12	GOVT	BPHC	
22	Amlat BPHC	Doro Joynagar, P.O. & P.S. Sutahata, Medinipur (E)	10	GOVT	BPHC	
23	Anantapur BPHC	Tamluk – I, Chansarpur, Medinipur (E)	10	GOVT	BPHC	
24	Bargashipur BPHC	Sutahata – II, Bargashipur, Medinipur (E)	10	GOVT	BPHC	
25	Bhupatinagar Mugberia BPHC	Bhagwanpur – II, P.O. & P.S. Bhupatinagar, Dist. Medinipur (E)	10	GOVT	BPHC	
26	Erashal BPHC	Nandigram - III, P.O.: Mathchandipur, East Midnapur	10	GOVT	BPHC	
27	Gangadharpur BPHC	Egra – II, Gangadharbhar, Medinipur (E)	10	GOVT	BPHC	
28	Gonara BPHC	Patashpur – II, Gonara, Medinipore (E)	10	GOVT	BPHC	
29	Janubasan (Haricharan Sashibhusan) BPHC	Tamluk – II, Norakuri Bazar, Medinipur (E)	10	GOVT	BPHC	
30	Kharipukhuria BPHC	Contai – III Block, Vill. Kharipukuria, PO. Nachinda, PS. Marishda, Medinipur (E)	10	GOVT	BPHC	
31	Sillaberia BPHC	Khejuri – II, Silaberia, Medinipore (E)	10	GOVT	BPHC	
32	Ajoya PHC	Khejuri – I, Ajoya, Medinipore (E)	20	GOVT	PHC	
33	Satmile PHC	Contai – I, Satmile, Medinipur (E)	20	GOVT	PHC	
34	Debhog PHC	Sutahata – II, Debhog, Medinipur (E)	15	GOVT	PHC	
35	Basantia BPHC	Chakgobindaberia, P.O. Basantia, P.S. Contai, Dist. Medinipur (E)	10	GOVT	PHC	
36	Chandanpur PHC	Ramnagar – I, chandipurhat, Medinipur (E)	10	GOVT	PHC	
37	Kelomal PHC	Tamluk – I, Kelomal, Medinipur (E)	10	GOVT	PHC	
38	Mohammadpur PHC	Nandigram – I, Rampur, Medinipur (E)	10	GOVT	PHC	
39	Nijmaithunu PHC	Ramnagar – II, Beltala, Medinipur (E)	10	GOVT	PHC	
40	Paniparul PHC	Egra – II, Paniparul, Medinipur (E)	10	GOVT	PHC	
41	Patanda (Maishara) PHC	Panskura – I, Shyamsundarpur (Patanda), Medinipur (E)	10	GOVT	PHC	
42	Pratapdighi PHC	Vill. & P.O. Pratapdighi, P.S. Patashpur, Dist. Medinipore (E)	10	GOVT	PHC	
43	Ramchandrapur PHC	P.O.Burarihat, P.S. Kolaghat, Tamluk – II, Mecheda,	10	GOVT	PHC	
44	Amdabad PHC	Nandigram – II, Amdabad, Medinipur (E)	6	GOVT	PHC	
45	Betamaheshpur PHC	Egra – II, Maheshpur, Medinipur (E)	6	GOVT	PHC	

DISTRICT WISE LIST OF BEDDED HCUs IN WEST BENGAL

INVENTORY: ANNEXURE - I

Sl. No	Name of the Units.	Address	Current Bed	Organisation	Category General	Category Special
46	Bibhisampur PHC	Bhagwanpur – I, Bibhisampur, Medinipur	6	GOVT	PHC	
47	Borhat PHC	Patahpur – II, Katranka, Medinipore (E)	6	GOVT	PHC	
48	Boyal PHC	Nandigram – II, Terapekhia, Medinipur (E)	6	GOVT	PHC	
49	Gobra PHC	Ramnagar – I, Gobra, Medinipur (E)	6	GOVT	PHC	
50	Heria PHC	Khejuri – I, Heria, Medinipore (E)	6	GOVT	PHC	
51	Janka PHC	Khejrui – II, Janka, Medinipore (E)	6	GOVT	PHC	
52	Kajalgarh PHC	Bhagwanpur – I, Kajalgarh, Medinipur (E)	6	GOVT	PHC	
53	Kulberia PHC	Contai – I, Kulberia, Medinipur (E)	6	GOVT	PHC	
54	Maheshpur PHC	Nandigram – I, Parulbari, Medinipur (E)	6	GOVT	PHC	
55	Nandaigajan PHC	Panskura – II, Bhogpur, Medinipur (E)	6	GOVT	PHC	
56	Natsal PHC	Mahisadal – II, Natsal, Medinipur (E)	6	GOVT	PHC	
57	Purba Itarah PHC	Panskura – I, Raghunathbati, Medinipur (E)	6	GOVT	PHC	
58	Ramchandrapur PHC	Egra, Kharbandhi, Medinipur (E)	6	GOVT	PHC	
59	Sadhihat PHC	P.O. Sadhihat, P.S. Ramnagar, Dist. Medinipur (E)	6	GOVT	PHC	
60	Seulipur PHC	Bhagwanpur – I, Seulipur, Medinipur (E)	6	GOVT	PHC	
61	Banamalichatta PHC	Contai – III, Banamalichatta, Medinipur (E)	4	GOVT	PHC	
62	Deulbari (Bahiri) PHC	Contai – III, Bairi, Medinipur (E)	4	GOVT	PHC	
63	Machinan PHC	Panskura – II, Gopalnagar, Medinipur (E)	4	GOVT	PHC	
64	Nayapur PHC	Contai – I, Nayapur, Medinipur (E)	4	GOVT	PHC	
65	Arankianara PHC	Mayna, Arankianara, Medinipur (E)	2	GOVT	PHC	
66	Baraghuni PHC	Nandigram – III, Baraghuni, Medinipur (E)	2	GOVT	PHC	
67	Barsundra PHC	Sutahata – II, Iswardah Jalpai, Medinipur (E)	2	GOVT	PHC	
68	Begunberia PHC	Sutahata – I, Begunberia, Medinipur (E)	2	GOVT	PHC	
69	Bhaitgarh PHC	Contai – III, Bhaitgarh, Medinipur	2	GOVT	PHC	
70	Chatla PHC	Egra – I, Chatla, Medinipur (E)	2	GOVT	PHC	
71	Dakshin Damodarpur PHC	Mahisadal – I, Damodarpur, Medinipur (E)	2	GOVT	PHC	
72	Dakshin Gumai PHC	Mahisadal – I, Kalyanchak, Medinipur (E)	2	GOVT	PHC	
73	Dhekua PHC	Sutahata – I, Dhekua, Medinipur (E)	2	GOVT	PHC	
74	Gokhuri PHC	Nandigram – I, Gokhuri, Medinipur (E)	2	GOVT	PHC	
75	Hamirpur (Karimpur) PHC	Ramnagar – II, Karimpur, Medinipur (E)	2	GOVT	PHC	
76	Kasabagola PHC	Egra – I, Panchrail, Medinipur (E)	2	GOVT	PHC	
77	Pichhaboni PHC	Ramnagar – I, Pichhaboni, Medinipore (E)	2	GOVT	PHC	

DISTRICT WISE LIST OF BEDDED HCUs IN WEST BENGAL

INVENTORY: ANNEXURE - I

Sl. No	Name of the Units.	Address	Current Bed	Organisation	Category General	Category Special
78	Purbonakha PHC	Tamluk – I, Srirampur, Medinipur (E)	2	GOVT	PHC	
79	Rajarampur PHC	Mahisadal – II, Rajarampur, Medinipur (E)	2	GOVT	PHC	
80	Ramchandrapur PHC	Mayna, Ramchandrapur, Medinipur (E)	2	GOVT	PHC	
81	Shyampur PHC	Egra – II, Shyampur, Medinipur (E)	2	GOVT	PHC	
82	Simulia PHC	Bhagwanpur – II, P.O. & P.S. Bhupatinagar, Simulia, Dist. Medinipur (E)	2	GOVT	PHC	
83	Uttar Dhalhara PHC	Tamluk – II, Uttar Dhalhara, Medinipur (E)	2	GOVT	PHC	
84	Argoal PHC	Vill & P.O. Argoal, P.S. Patashpur, Dist. Medinipore (E)	0	GOVT	PHC	
85	Barberia PHC	Bhagwanpur – II, P.O. Barberia, P.S. Bhupatinagar, Dist. Medinipur (E)	0	GOVT	PHC	
86	Daulatpur PHC	Vill. Daulatpur, P.O. Dariapur, P.S. Contai, Dist. Medinipur (E)	0	GOVT	PHC	
87	Khaila's Maternity cum Nursing Home	Basudevpur, Khanjanchak, Durgachak, Purba Medinipore	10	GOVT	N. Home	
88	Haldia Refinery Hospital	IOC Ltd., Haldia Township, Dist. Midnapore (E)	24	GOVT	IOCL	
89	Port Hospital	Haldia, Dock Complex, Medinipore (E)	48	GOVT	PORT	
90	Dr. B. C. Roy Hospital	Bonbishnupur, P.O.: Balughata, P.S.: Bhawanipur, Haldia,	100	PVT	N.HOME	
91	Vivekananda Mission Ashram Netra Niramay Niketan	Viveknagar, P.O. Chaitanyapur, Haldia, Dist. Medinipore (E),	100	PVT	N.HOME	
92	B. L. Memorial Hospital	Padmapuluria, Contai, East Medinipore	45	PVT	N.HOME	
93	Victoria Hospital & Research Center	Sankara, P.O. & P.S.: Tamluk, Midnapur (E)	30	PVT	N.HOME	
94	Manideepa Nursing Home	Vill. Shankara, P.O. Tamluk, Midnapore (E)	26	PVT	N.HOME	
95	SAB Nursing Home & Diagnostic Center	Basudevpur, Haldur, Khanjanchak, Midnapore (E)	25	PVT	N.HOME	
96	Haldia Lions Eye Health Care & Research Centre	Lions Park, Durgachak, Haldia, Purba Medinipore	20	PVT	N.HOME	EYE
97	Chandipur Nursing Home	Chandipur, East Midnapore	20	PVT	N.HOME	
98	Life Line Nursing Home & Diagnostic	Hariharpur, Baliachak, Midnapore(E)	20	PVT	N.HOME	
99	Mallika Seva Sadan	School Bazar, P.O. & P.S. Contai, Midnapore (E)	20	PVT	N.HOME	
100	Mamata Nursing Home	Vill. Daharpur, P.O. & P.S. Tamluk, Medinipur (E)	20	PVT	N.HOME	
101	Medi Land Nursing Home	Basudevpur, P.O. Khanjanchak, P.S. Durgachak, Haldia,	20	PVT	N.HOME	
102	Popular Nursing Home	Mechada, East Midnapore	18	PVT	N.HOME	
103	Pranabananda Seva Sadan	Tamluk Hospital More (S), Sankara, Midnapore(E)	16	PVT	N.HOME	
104	Seva Nursing Home	Padmabhusan, P.O. & P.S.: Tamluk, Midnapore (E)	16	PVT	N.HOME	
105	Bhuban Parameswari Nursing Home	Egra, Daloluo, Medinipore (E)	15	PVT	N.HOME	
106	New Saradamoyee Maternity & Sishu Niketan	Vill.: Santipur, P.O.: Mechada, P.S.: Kolaghat, Purba Medinipore	15	PVT	N.HOME	
107	New Vivekananda Nursing Home	Padmabhusan, P.O. & P.S.: Tamluk, Midnapore (E)	15	PVT	N.HOME	
108	Ramkrishna Arogya Niketan	Daharpur, Tamluk, Medinipur (E)	15	PVT	N.HOME	
109	Saradamoyee Seva Sadan	Vill. Daharpur, P.O. & P.S. Tamluk, Medinipore (E)	15	PVT	N.HOME	

DISTRICT WISE LIST OF BEDDED HCUs IN WEST BENGAL

INVENTORY: ANNEXURE - I

Sl. No	Name of the Units.	Address	Current Bed	Organisation	Category General	Category Special
110	Tamralipta Health Home (P) Ltd.,	Town Padumbassan, P.O. Tamluk, Medinipur (E)	15	PVT	N.HOME	
111	Apolo Nursing Home	Kolaghat, Panskura - II, East Midnapore	12	PVT	N.HOME	
112	Al Amin Matangini Nursing Home	Vill.: Dalalua, P.O. & P.S.: Egra, Purba Medinipore	10	PVT	N.HOME	
113	Ambika Seva Sadan	Lalgachhari, P.O. Ramnagar, Contai, East Midnapore	10	PVT	N.HOME	
114	Anamika Nursing Home	Bhabanipur, Haldia East Midnapur	10	PVT	N.HOME	
115	Arogya Nursing Home & Poly Clinic	Vill. & P.O. Kolaghat, Medinipur (E)	10	PVT	N.HOME	
116	Bargabhima Nursing Home	Vill. Sankarara, P.O. Tamluk, Midnapore (E)	10	PVT	N.HOME	
117	Binodini Matri Seva Sadan	Garhkamalpur, P.O. & P. S. Mahisadal, Midnapore (E)	10	PVT	N.HOME	
118	Charuchandra Seva Sadan (P) Ltd.	Alhilagari, Contai, East Midnapore	10	PVT	N.HOME	
119	Contai Nursing Home	Uttar Darna, Contai Medinipore (E)	10	PVT	N.HOME	
120	Dhanwantari Nursing Home	Vill.: Dalalua, P.O. & P.S.: Egra, Purba Medinipore	10	PVT	N.HOME	
121	Digha Nursing Home	New Digha, Midnapore (E)	10	PVT	N.HOME	
122	Green Land Nursing Home	Daharpur, Tamluk, Medinipur (E)	10	PVT	N.HOME	
123	Haldia Seva Sadan	Debhog, Bhawanipur, Haldia Midnapur (E)	10	PVT	N.HOME	
124	Jeevan Deep Maternity cum Nursing Home	sankara, Midnapore (E)	10	PVT	N.HOME	
125	Jeevandeep Nursing Home	Kanakpur, P.O. & P.S.- Panskura, Purba Medinipore	10	PVT	N.HOME	
126	K.P. Nursing Home	Sahapore, Mangalmaro, Purba Medinipur	10	PVT	N.HOME	
127	Kamala Nursing Home	Udyan Cinema Road, Vill. Athilagori, P.O. Contai, Midnapore Purba	10	PVT	N.HOME	
128	Kusum Joyti Nursing Home	Sherpur Kharkibarih, Contai, Medinipore (E)	10	PVT	N.HOME	
129	Life Line Nursing Home	Egra, Medinipur (E)	10	PVT	N.HOME	
130	Life Link Nursing Home	Vill. Athilagori, School Bazar, P.O. & P.S. Contai, Medinipore (E)	10	PVT	N.HOME	
131	Lions Club of Contai Bholanath Memorial Eye Hospital	Contai, Midnapore (E)	10	PVT	N.HOME	
132	Maa Sarada Nursing Home	Vill.: Dakshin Mechogram, P.O.: Dehati, P.s.: Panskura,	10	PVT	N.HOME	
133	MARCH Hospital	Nischintabsan, Bahichard, Tamluk, Dist. Midnapore	10	PVT	N.HOME	
134	Matangini Medical Mission Nursing Home	Chakkamina, P.O. & P.S.: Tamluk, East Midnapore	10	PVT	N.HOME	
135	Modern Polyclinic & Nursing Home	Vill. & P.O. & P.S.: Kolaghat, Purba Medinipore	10	PVT	N.HOME	
136	Mother Land Nursing Home	Kalikakhali, P.O.: Ramkrishnapur, P.S.: Mathchandipur, East Midnapore	10	PVT	N.HOME	
137	Mother Nursing Home	Kalikakhali, P.O. & P.S.- Math Chandipur, Mednapur (E)	10	PVT	N.HOME	
138	Mother Nursing Home	Daharpur, P.O. Tamluk, Midnapore Purba	10	PVT	N.HOME	
139	Nabajiban Maternity cum Nursing Home	Egra, Medinipur (E)	10	PVT	N.HOME	
140	National Institute Of Mordern Medicine & Research	Nioschintabasan, P.O. Bahichard, P.S. Tamluk, Midnapore (E)	10	PVT	N.HOME	
141	New Life Line Nursing Home	Vill. Arhashal, P.O. Mathachandipur, Midnapore (E)	10	PVT	N.HOME	

DISTRICT WISE LIST OF BEDDED HCUs IN WEST BENGAL

INVENTORY: ANNEXURE - I

Sl. No	Name of the Units.	Address	Current Bed	Organisation	Category General	Category Special
142	New Ma Sarada Nursing Home	Vill.: Dakshin Mechogram, P.O.: Dehati, P.s.: Panskura,	10	PVT	N.HOME	
143	New Nivedita Nursing Home & research Centre	Vill. Santipur, P.O. Mechheda, Midnapore (E)	10	PVT	N.HOME	
144	Niramoy Nursing Home	Vill. Bahargram, P.O. & P.S. Panskura, Midnapore (E)	10	PVT	N.HOME	
145	Nistha Nursing Home	Dalaua, Egra, Medinipore (E)	10	PVT	N.HOME	
146	Priyanath Seva Sadan	Monoharchak, Contai, Midnapore (E)	10	PVT	N.HOME	
147	Red Cross Netra Niramoy Kendra	Contai, Midnapore (E)	10	PVT	N.HOME	
148	Relief Nursing Home	Sankara, Tamluk, East Midnapur	10	PVT	N.HOME	
149	Sabitri Nursing Nome	Daharpur, P.O. Tamluk, Midnapore Purba	10	PVT	N.HOME	
150	Sister Nursing Home	Vill.: Deuliabazar, P.O. & P.S.: Kolaghat, Purba Medinipore	10	PVT	N.HOME	
151	Subhalakshmi Nursing Home	Dakshin Gopalpur, Panskura, Puratan Bazar, Purba Medinipur	10	PVT	N.HOME	
152	Swarupananda Seva Pratishtan	Kasba Egra, Midnapore (E)	10	PVT	N.HOME	
153	Vivekananda Nursing Home	Vill.: Kakdih, P.O.: Mechheda, P.S.: Kolaghat, Medinipore (E)	10	PVT	N.HOME	
154	Vivekananda Nursing Home	Vill: Daharpur P.O. & P.S.: Tamluk Midnapur (E)	10	PVT	N.HOME	
155	Sreema Nursing Home	Salgachhia, P.O. & P.S.: Tamluk, Midnapore (E)	9	PVT	N.HOME	
156	Egra Sriguru Nursing Home Cum Maternity	Egra, East Medinipore	9	PVT	N.HOME	
157	Anindita Nursing Home	Deulia, Kolaghat, East Medinipore	9	PVT	N.HOME	
158	Marry Land Nursing Home	Monoharchak, Contai, Midnapore (E)	8	PVT	N.HOME	
159	Care & Cure Seva Sadan	Basudevpur, Haldur, Khanjanchak, Midnapore (E)	8	PVT	N.HOME	
160	Dr. S. K. Tamili	Egra, Medinipur (E)	6	PVT	N.HOME	
161	Green Land Clinic	Garhkamalpur, P.O. & P. S. Mahisadal, Midnapore (E)	6	PVT	N.HOME	
162	Kalamamoyee Matri Sadan Nursing Home	Nandakumar, East Midnapore	6	PVT	N.HOME	
163	Maity Nursing Home	Dakshin Harkuli, P.O. Dakshin Moyna, P.S.- Moyna, Midnapore (E)	6	PVT	N.HOME	
164	Medicure Nursing Home	Vill & P.O.: Sudampur, P.S. Moyna, Midnapur (E)	6	PVT	N.HOME	
165	Mother Teraja Nursing Home	Panskura - I, East Midnapore	6	PVT	N.HOME	
166	Moumita Nursing Home	Vill. & P.O. Bhupatinagar, Midnapore (E)	6	PVT	N.HOME	
167	Nibedita Nursing Home	Vill.: Kakdih, P.O.: Mechheda, P.S.: Kolaghat, Medinipore (E)	6	PVT	N.HOME	
168	Park Nursing Home	Gandhi Road, Hatabari Contai, Medinipore (E)	6	PVT	N.HOME	
169	Puja Nursing Home	Monoharchak, Contai, Midnapore (E)	6	PVT	N.HOME	
170	Sevayatan Clinic, Maternity & Nursing Home	Egra, Medinipur (E)	6	PVT	N.HOME	
171	Sishu Seva Sadan Nursing Home	Vill. Salgachi, P.O. Tamluk, Mednapore (E)	6	PVT	N.HOME	
172	Sudha Nursing Home	Basudevpur, P.O. Khanjanchak, Haldia, Midnapore (E)	6	PVT	N.HOME	
173	Uttaran Nursing Home	Dhandighi, Contai, Medinipore (E)	6	PVT	N.HOME	

DISTRICT WISE LIST OF BEDDED HCUs IN WEST BENGAL

INVENTORY: ANNEXURE - I

Sl. No	Name of the Units.	Address	Current Bed	Organisation	Category General	Category Special
174	Ashirbad Nursing Home	Vill.: Kalaberia, P.O. & P.S.: Mahishadal, Purba Medinipore	5	PVT	N.HOME	
175	Asirbad Maternity cum Nursing Home	Egra, Medinipur (E)	5	PVT	N.HOME	
176	Astha Nursing Home	Vill. Hatishal, P.O. Jiakhali, Midnapore (E)	5	PVT	N.HOME	
177	Bhakta Clinic & Nursing Home	Vill. & P.O. Mahisadal, Medinipur (E)	5	PVT	N.HOME	
178	Bimala Nursing Home	Vill. Bahargram, P.O. Panskura, Dist. Medinipur (E)	5	PVT	N.HOME	
179	Child Care Clinic	College Road, Egra, Medinipore (E)	5	PVT	N.HOME	
180	Debendra Nursing Home	Vill.: Dakshin Mechogram, P.O.: Uttar Mechogram, P.S.: Panskura,	5	PVT	N.HOME	
181	Genesis Maternity & Child Welfare Centre	Vill. Dharinda, P.O. & P.S. Tamluk, Midnapore (E)	5	PVT	N.HOME	
182	Janakalyan Seva Sadan (Polyclinic & Nursing Home)	Vill.: Erashal, P.O.: Math Chandipur, P.S.: Chandipur,	5	PVT	N.HOME	
183	Kabita Nursing Home	P.O. & P.S. Marisda, Midnapore (E)	5	PVT	N.HOME	
184	Kohinoor Nursing Home	Godaibalbarh, P.O. Nandigram, Midnapore (E)	5	PVT	N.HOME	
185	Ma Durga Seba Sadan	Vill.: Bahargram, P.O.: Panskura R. S., P.S.: Panskura, Midnapore (E)	5	PVT	N.HOME	
186	Matrik Nursing Home	HPL Link Road, Basudevpur, Haldia East Midnapur	5	PVT	N.HOME	
187	Monalisha Nursing Home	Vill & P.O.-Nandigram, Medinipur (E)	5	PVT	N.HOME	
188	Nabajiban Nursing Home	Basudevpur, P.O. Khanjanchak, P.S. Durgachak, Haldia,	5	PVT	N.HOME	
189	New Anandoloke Nursing Home	Kakdihi, P.O.: Mechada, P. S.: Kolaghat, East Midnapore	5	PVT	N.HOME	
190	New Digha Nursing Home	New Digha, Contai, East Midnapore	5	PVT	N.HOME	
191	Niramoy Nursing Home	Sherpur Karki, Contai, Medinipore (E)	5	PVT	N.HOME	
192	Paradise Diagnostic Center & Nursing Home	Vill.: Dharinda, P.O. & P. S.: Contai, Purba Medinipore	5	PVT	N.HOME	
193	Ramananda Seba Sadan Cum Nursing Home	Vill, Po. Paramanandapur Medinipur (E)	5	PVT	N.HOME	
194	Ramkrishna Nursing Home	Vill. Kalikahali, P.O. Mathchandipur, Medinipur (E)	5	PVT	N.HOME	
195	Ramkrishna Nursing Home & Poly Clinic	Vill. Kakdihi, P.O. Mecheda, P.S. Kolaghat, Midnapore Purba	5	PVT	N.HOME	
196	Sarada Nursing Home	Vill. Talgachhari, P.O. Ramnagar, Medinipur (E)	5	PVT	N.HOME	
197	Scientific Treatment Center	Bajkul, P.O. Kismat Bajkul, P.S. Bhupatinagar, Midnapore (E)	5	PVT	N.HOME	
198	The Allen Clinic & matrimangal Nursing Home	Vill. & P.O. & P.S.: Bhupatinagar, Purba Medinipore	5	PVT	N.HOME	
199	The Chaitanyapur Nursing Home	Vill & P.O.- Chaitanyapur, P.S. Sutahata, Medinipur (E)	5	PVT	N.HOME	
200	Udyan Maternity cum Nursing Home	Mangalamaro, Dist. East Medinipur	5	PVT	N.HOME	
201	Vivekananda Eye Care Centre	Ratuliala Polly Bikash Kendra, Ratulia, Panskura, Purba Medinipore	5	PVT	N.HOME	
202	Chaitanyapur Nursing Home	Chaitanyapur, East Medinipore	5	PVT	N.HOME	
203	Anandam Nursing Home	Thana Pukur Road, Athilagari, P.O. Contai, Midnapore Purba	4	PVT	N.HOME	
204	Haji Medical Nursing Home	Delulihat, Sogaseswar, P.S. Rasmnagar-I, East Midnapore	4	PVT	N.HOME	
205	Kshirodamoni Nursing Home	Mangalamaro Bus Stand, Egra, Dist. Medinipur (E)	4	PVT	N.HOME	

DISTRICT WISE LIST OF BEDDED HCUs IN WEST BENGAL

INVENTORY: ANNEXURE - I

Sl. No	Name of the Units.	Address	Current Bed	Organisation	Category General	Category Special
206	Nivedita Diagnostic & Research Hospital Pvt. Ltd.,	Kalikaldali, P.S. Chandipur, Midnapore (E)	4	PVT	N.HOME	
207	Ramkrishna Seva Sadan Cum Nursing Home	P.O.: Paramanandapur, P.S.: Moyna, Midnapur (E)	4	PVT	N.HOME	
208	Upasam Nursing Home	Bahagram, Panskura, Purba Medipore	4	PVT	N.HOME	
209	Medysist Hospital & Research Centre Pvt. Ltd.	Serpur, Etwarubarh, P.O. & P.S. Contai, Midnapore (E)	3	PVT	N.HOME	
210	Nivedita Nursing Home	Kakdihi, P.O.: Mechada, P. S.: Kolaghat, East Midnapore	3	PVT	N.HOME	
211	Pal Clinic (Nursing Home)	Vill. Basudevpur, P.O. Khanjanchak, P.S. Durgachak, Midnapor (E)	2	PVT	N.HOME	
212	Port Land Nursing Home	Basudevpur, P.O. Khanjanchak, Midnapore (E)	2	PVT	N.HOME	
213	Shyama Nursing Home & Maternity Centre	Vill. & P.O. Chaitanyapur, Midnapore (E)	2	PVT	N.HOME	
		TOTAL NUMBER OF BEDS IN EAST MIDNAPORE DISTRICT:	2781			
HOOGHLY						
1	Imambara Sadar Hospital (Dist Hospital) Hooghly	P.O. Chinsurah, Dist. Hooghly	540	GOVT	DH	
2	S.D. Hospital – Serampore (Walsh)	P.S. & P.O. Serampore, Dist. Hooghly, Pin : 712 201	266	GOVT	SD	
3	S.D. Hospital – Arambagh	Arambagh (M), P.O. Arambagh, Dist. Hooghly	250	GOVT	SD	
4	S. D. Hospital – Chandannagar	Chandannagar, P.O. Chandannagar, Hooghly	250	GOVT	SD	
5	Uttarpara State General Hospital	P.O. Uttarpara, Dist. Hooghly, Pin : 712 258	204	GOVT	SG	
6	Jangipara Rural Hospital	P.O. & Vill. Jangipara, Hooghly	60	GOVT	RH	
7	Singur Rural Hospital	P.O. Singur, Dist. Hooghly	60	GOVT	RH	
8	Tarakeswar Rural Hospital	P.O. Tarakeswar, Dist. Hooghly	60	GOVT	RH	
9	Chanditala Rural Hospital	P.O. Chanditala, Dist. Hospital	30	GOVT	RH	
10	Dhaniakhali Rural Hospital	P.O. Dhaniakhali, Hooghly	30	GOVT	RH	
11	Haripal Rural Hospital	P.O. Khamarchandi, PS. Haripal, Dist. Hooghly	30	GOVT	RH	
12	Khanakul Rural Hospital	P.O. Khanakul, Dist. Hooghly	25	GOVT	RH	
13	Pandua Rural Hospital	P.O. Pandua, Dist. Hooghly	25	GOVT	RH	
14	Chinsurah Mogra BPHC	P.O. & P.S. Mogra, Dist. Hooghly	25	GOVT	BPHC	
15	Akuni Ichhapur BPHC	Chanditala – I, P.O. Aniya, Hooghly	15	GOVT	BPHC	
16	Kamarpukur BPHC	Goghat – II, P.O. Kamarpukur, Hooghly	15	GOVT	BPHC	
17	Polba BPHC	Polba, P.O. Polba, Hooghly	15	GOVT	BPHC	
18	Serampore (Pursurah) BPHC	P.O. Ankri Serampore, Serampore, Dist. Hooghly	15	GOVT	BPHC	
19	Ahmedpur BPHC	Balagarh, P.O. Pataligram, Hooghly	10	GOVT	BPHC	
20	Dakshin Narayanpur BPHC	Arambagh, P.O. Helen, Hooghly	10	GOVT	BPHC	
21	Natibpur BPHC	Khanakul – II, P.O. Natibpur, Hooghly	10	GOVT	BPHC	
22	Kanaipur BPHC	P.O. Kanaipur, PS. Uttarpara, Dist. Hooghly	6	GOVT	BPHC	

DISTRICT WISE LIST OF BEDDED HCUs IN WEST BENGAL

INVENTORY: ANNEXURE - I

Sl. No	Name of the Units.	Address	Current Bed	Organisation	Category General	Category Special
23	Balagarh PHC	Balagarh, P.O. Balagarh, Hooghly	15	GOVT	PHC	
24	B.L. Mukherjee PHC at Boinchigram	Pandua, P.O. Boinchi, Hooghly	10	GOVT	PHC	
25	Bakulia PHC	Balagarh, P.O. Bakuliagram, Hooghly	10	GOVT	PHC	
26	Balarambati PHC	Singur, P.O. Balarambati, Hooghly	10	GOVT	PHC	
27	Bandipur PHC	Haripal, P.O. Bandipur, Hooghly	10	GOVT	PHC	
28	Bejemelia PHC	Singur, P.O. Gopalnagar, Hooghly	10	GOVT	PHC	
29	Belmuri PHC	Dhaniakhali, P.O. B.C. Bati, Hooghly	10	GOVT	PHC	
30	Bhandarhati PHC	Dhaniakhali, P.O. Bhandarhati, Hooghly	10	GOVT	PHC	
31	Bora PHC	Singur, P.O. Bora, Hooghly	10	GOVT	PHC	
32	Chopa PHC	Dhaniakhali, P.O. Chopa, Hooghly	10	GOVT	PHC	
33	Dumurdaha-Nityanandapur PHC	Balagarh, PP.O. Gopalpur, Hooghly	10	GOVT	PHC	
34	Gurup PHC	Dhaniakhali, P.O. Palashi, Hooghly	10	GOVT	PHC	
35	Itachuna PHC	Pandua, P.O. Itachuna, Hooghly	10	GOVT	PHC	
36	Khejurdaha Milki PHC	Dhaniakhali, P.O. Bhastara, Hooghly	10	GOVT	PHC	
37	Makalpur PHC	Polba, P.O. Makalpur, Hooghly	10	GOVT	PHC	
38	Malaypur PHC	Arambagh, P.O. Keshabpur, Hooghly	10	GOVT	PHC	
39	Mundalika PHC	Jangipara, P.O. Dingalhati, Hooghly	10	GOVT	PHC	
40	Muthadanga PHC	Arambagh, P.O. Mayapur, Hooghly	10	GOVT	PHC	
41	Rameswarpur Gopalnagar PHC	Pandua, P.O. Chandpur, Hooghly	10	GOVT	PHC	
42	Sabalsinghpur PHC	Khanakul – II, P.O. Sabalsinghpur, Hooghly	10	GOVT	PHC	
43	Selepur PHC	Arambagh, P.O. Chuadanga, Hooghly	10	GOVT	PHC	
44	Tantisal PHC	Khanakul – I, P.O. Tantisal, Hooghly	10	GOVT	PHC	
45	Chapsara PHC	Serampore – Uttarpara, P.O. Chapsara, Hooghly	6	GOVT	PHC	
46	Guptipara PHC	Balagarh, P.O. Guptipara, Hooghly	6	GOVT	PHC	
47	Jamgram PHC	Pandua, P.O. Jamgram Hooghly	6	GOVT	PHC	
48	Janai Baksha PHC	Chanditala – II, P.O. Janai, Hooghly	6	GOVT	PHC	
49	Jangalpara PHC	Chanditala – I, P.O. Jangalpara, Hooghly	6	GOVT	PHC	
50	Nakunda PHC	Goghat – I, P.O. Nakunda, Hooghly	6	GOVT	PHC	
51	Olipur PHC	Haripal, P.O. Olipur, Hooghly	6	GOVT	PHC	
52	Porabazar PHC	Dhaniakhali, P.O. Porabazar, Hooghly	6	GOVT	PHC	
53	R.N. Debdas (Naldanga) PHC,	Chinsurah, P.O. Bandel, Hooghly	6	GOVT	PHC	
54	Rajbalhat PHC	Jangipara, P.O. Rajbalhat, Hooghly	6	GOVT	PHC	

DISTRICT WISE LIST OF BEDDED HCUs IN WEST BENGAL

INVENTORY: ANNEXURE - I

Sl. No	Name of the Units.	Address	Current Bed	Organisation	Category General	Category Special
55	Ramchandrapur PHC	Khanakul – II, P.O. Ramchandrapur, Hooghly	6	GOVT	PHC	
56	Tarahat PHC	Goghat – II, P.O. Tarahat, Hooghly	6	GOVT	PHC	
57	Digsui PHC	Chinsura-Mogra, P.O. Digsui, Dist. Hooghly	6	GOVT	PHC	
58	Bansberia PHC	Bansberia (M), P.O. Bansberia, Hooghly	5	GOVT	PHC	
59	Bhadrahal PHC	Uttarpara (M), P.O. Uttarpara, Hooghly	5	GOVT	PHC	
60	Begampur PHC	Chanditala – II, P.O. Begampur, Hooghly	4	GOVT	PHC	
61	Bhattapur PHC	Chanditala – I, P.O. Akundi, Hooghly	4	GOVT	PHC	
62	Danarpur PHC	Polba, P.O. Danarpur, Hooghly	4	GOVT	PHC	
63	Dihibagnan PHC	Arambagh, P.O. Dihibagnan, Hooghly	4	GOVT	PHC	
64	Dihibatipur PHC	Pursurah, P.O. Alati, Hooghly	4	GOVT	PHC	
65	Duttapur PHC	Tarakeswar, P.O. Duttapur, Hooghly	4	GOVT	PHC	
66	Dwarbasini PHC	Pandua, P.O. Dwarbasini, Hooghly	4	GOVT	PHC	
67	Fatepur PHC	Pusurah, P.O. Purshyampur, Hooghly	4	GOVT	PHC	
68	Furfurah PHC	Jangipara, P.O. Furfurah, Hooghly	4	GOVT	PHC	
69	Gangadharpur PHC	Chanditala – I, P.O. Gangadharpur, Hooghly	4	GOVT	PHC	
70	Ghoshpur PHC	Khanakul – I, P.O. Pilkhan, Hooghly	4	GOVT	PHC	
71	Guti PHC	Jangipara, P.O. Gutti, Hooghly	4	GOVT	PHC	
72	Haraldaspur PHC	Pandua, P.O. Hatni, Hooghly	4	GOVT	PHC	
73	Harimohan Golap Sundari PHC	Khanakul – I, P.O. Raghunathpur, Hooghly	4	GOVT	PHC	
74	Kamdebpur (Sugandah) PHC	Polba, P.O. Sugandah, Hooghly	4	GOVT	PHC	
75	Mohipalpur PHC	Balagarh, P.O. Brindabanpur, Hooghly	4	GOVT	PHC	
76	Sukharia PHC	Balagarh, P.O. Somra, Hooghly	4	GOVT	PHC	
77	Talpur PHC	Tarakeswar, P.O. Talpur, Hooghly	4	GOVT	PHC	
78	Badanganj PHC	Goghat – II, P.O. Badanganj, Tarahat, Hooghly	2	GOVT	PHC	
79	Goghat PHC	Goghat – II, P.O. Kamarpukur, Hooghly	2	GOVT	PHC	
80	Jitarpur PHC	Goghat – II, P.O. Kamarpukur, Hooghly	2	GOVT	PHC	
81	Morakhana PHC	Khanakul – II, P.O. Morakhana, Hooghly	2	GOVT	PHC	
82	Rajyadharpur PHC	Serampore-Uttarpara, P.O. Serampore, Hooghly	2	GOVT	PHC	
83	Rupali Nandi Cancer Research Centre	Chandannagar (M), P.O. Chandannagar, Hooghly	30	GOVT	CG	CAN
84	Hooghly Jail Hospital	Chinsurah (M), P.O. Chinsurah, Hooghly	27	GOVT	SGJ	
85	Bandel E.S.I. Hospital	Bandel, Hooghly	286	GOVT	SGL	
86	E.S.I. Hospital – Serampore	P.O. Serampore. Dist. Hooghly.	216	GOVT	SGL	

DISTRICT WISE LIST OF BEDDED HCUs IN WEST BENGAL

INVENTORY: ANNEXURE - I

Sl. No	Name of the Units.	Address	Current Bed	Organisation	Category General	Category Special
87	Gourhati E.S.I. Hospital	G. T. Road, P.O. Gourhati, Hooghly	216	GOVT	SGL	
88	Chinsurah Police Hospital	Chinsurah, P.O. Chinsurah, Hooghly	99	GOVT	SGP	
89	Vagrant's Home (Female)	Srirampore (M), P.O. Srirampore, Hooghly	2	GOVT	SGV	
90	Srirampore T.B. Hospital	Srirampore (M), P.O. Srirampore, Hooghly	55	GOVT	TB	TB
91	Rishra Matri Sadan	Rishra , P.O. Rishra, Hooghly	10	GOVT	MUNI	MNTY
92	Ankur Maternity & Child Health Welfare Centre	G.T. Road, Talinipara, Bhadreswar, Hooghly	100	GOVT	MUNI	MNTY
93	Konnagar Matri Sadan 'O' Sishu Mangal Pratisthan	Konnagar (M), P.O. Konnagar, Hooghly	43	GOVT	MUNI	MNTY
94	Dishari (Chandernagar Corporation)	Bramhinpara, Chandernagar, Hooghly	40	GOVT	MUNI	
95	Bansberia Maternity Home	Shibpur, Tribeni, Bansberia, Hooghly	20	GOVT	MUNI	MNTY
96	Champdani Municipal Maternity Home & Child Care Center	Champdani, Hooghly	20	GOVT	MUNI	MNTY
97	ESOPD & Maternity Home	Subhasnagar, Rishra, Hooghly	20	GOVT	MUNI	MNTY
98	Bandel Thermal Power Station Hospital	Bansberia (M), P.O. Tribeni, Hooghly	10	GOVT	SEB	
99	Bandel Rly. Hospital	Polba (B), P.O. Bandel, Hooghly	4	GOVT	RLY	
100	Mental Hospital – Mankundu	Bhadreswar (M), P.O. Mankundu, Hooghly	180	PVT	N.HOME	
101	Rishra Seva Sadan	2, K.C. Sen Road, Rishra, Hooghly	146	PVT	N.HOME	
102	Care Concern Hospital (P) Ltd.	87/A, G. T. Road (West), P.O.: Mallick Para, P.S.: Serampore,	100	PVT	N.HOME	
103	Manikamal Hospital & Research Centre	Choto Belu, Delhi Road, PO. Seoraphuly, Hooghly	100	PVT	N.HOME	
104	Ram Mohan Mission Eye Hospital	Serampore, Dist.: Hooghly	100	PVT	N.HOME	
105	Arogya Niketan Pvt. Ltd.,	105, R.S.Verma Road, P.O. Uttarpara, Hooghly	61	PVT	N.HOME	
106	Dankuni Life Care Hospital (P) Ltd.	Vill.: Kalikapur, P.O.: Garalgacha, P.S.: Dankuni, Hooghly	50	PVT	N.HOME	
107	Galaxy Medicare & Research Centre, .	T.C. Mukherjee Street, Rishra, Hooghly	50	PVT	N.HOME	
108	Kamala Ray Hospital (P) Ltd.	20, Kotrang, G. T. Road, P.O.: Hindmotor, Hooghly	50	PVT	N.HOME	
109	We Care (Nursing Home & Diagnostic Center)	101/1/Z/Z/M, R. S, Verma Road, P.O.: Uttarpara, Hooghly	50	PVT	N.HOME	
110	Dunlop Hospital,	P.O. Sahaganj, Hooghly	40	PVT	N.HOME	
111	Gita Seva Sadan	Pollishree, Arambagh, Hooghly	40	PVT	N.HOME	
112	Seva Hospital & Research Centre,	Vivekananda Pally, P.O.: & P.S.: Tarakeswar, Hooghly	40	PVT	N.HOME	
113	H. M. Hospital	Hindmotor, Hooghly	37	PVT	N.HOME	
114	Badal Ch. Das Memorial Medical Complex Centre,	Burdwan Road, Tarakeswar, Hooghly	35	PVT	N.HOME	
115	Neel Jheel Nursing Home Pvt. Ltd.,	629, G.T.Road, P.O. Serampore	35	PVT	N.HOME	
116	Arambagh Lions Eye Hospitals	Arambagh, Hooghly	30	PVT	N.HOME	EYE
117	Chinsurah Medicare Nursing Home & Research Centre	Chinsurah, Hooghly	30	PVT	N.HOME	
118	Nalini Nursing Home,	Pollisree, P.O. Arambagh.	30	PVT	N.HOME	

DISTRICT WISE LIST OF BEDDED HCUs IN WEST BENGAL

INVENTORY: ANNEXURE - I

Sl. No	Name of the Units.	Address	Current Bed	Organisation	Category General	Category Special
119	Nilima Matri Sadan,	22, Sibnarayan Road, P.O. & P.S.: Uttarpara, Hooghly	30	PVT	N.HOME	
120	Paramount Nursing Home	148 & 151, G. T. Road, Manicktala, Serampore, Hooghly	30	PVT	N.HOME	
121	Swasti Nursing Home,	Mogr Station Road, P.O. & P.S.: Mogra, Hooghly	30	PVT	N.HOME	
122	Disha Eye Hospital (Hooghly) PVT. Ltd.	14, G. T. Road, Sheoraphully, Hooghly	25	PVT	N.HOME	EYE
123	Rotary Eye Hospital	61, Hansewri Road, Bansberia, Hooghly	25	PVT	N.HOME	EYE
124	Arogya Niketan (Nursing Home),	Office Para, Vill. Barijhaty, P.O. Chanditala, Hooghly	25	PVT	N.HOME	
125	Calcutta Lions Ramkrishnabati Hospital,	Ramkrishnabari, P.O. Mrigala., Hooghly	25	PVT	N.HOME	
126	City Nursing Home,	Court Road, (Near Bus Stand) Arambagh, Hooghly.	25	PVT	N.HOME	
127	Jerambhai Medical Center	12A, Satya Charan Shastri Street, P.O.: Rishra, Hooghly	25	PVT	N.HOME	
128	K. D. Nursing Home	Dhaniakhali, Hooghly	25	PVT	N.HOME	
129	Lions Club Dhaniakhali Janendra Memorial Child Health Care	Dhaniakhali, Hooghly	25	PVT	N.HOME	
130	Mahamaya Matrimangal Kendra	Shaker Bazar, Hooghly	25	PVT	N.HOME	
131	Makhla Seva Sadan	260, T. N. Mukherjee Road, Raghunathpur, Hooghly	25	PVT	N.HOME	
132	Meditek Center	Chabighar more, P O.Chandannagar, Hooghly.	25	PVT	N.HOME	
133	Park Lions Hospital & Research Institute	Hindmotor, Hooghly	25	PVT	N.HOME	
134	Sanjibani Hospital	Vill & P.O.: Dakshin Rasulpur, P.S.: Arambag, Hooghly	25	PVT	N.HOME	
135	United Nursing Home Co-Operative Society Ltd.,	Barabazar. P.O. Chandernagar.	25	PVT	N.HOME	
136	Vivekannanda Seva Sadan	Dhaniakhali (B), P.O. Mandra, Hooghly	25	PVT	N.HOME	
137	Indian Red Cross, Hooghly	Tamlipara, Hooghly	23	PVT	N.HOME	
138	King George Maternity Home & Hospital	Chinsurah (M), P.O. Chinsurah. Hooghly	23	PVT	N.HOME	
139	Amala Nursing Home,	Karbala More, Vivekananda Road, P.O. Hooghly.	20	PVT	N.HOME	
140	Anandamayee Seva Niketan	Khajurdaha, P. S. Dhaniakhali, Hooghly	20	PVT	N.HOME	
141	Aparupa Matrisadan	Sheoraphully, Hooghly	20	PVT	N.HOME	
142	Arogya Niketan,	Pankhatuli, Hooghly.	20	PVT	N.HOME	
143	Chandannagore Mental Health Home	Tematha, P.O. Chandannagore.	20	PVT	N.HOME	
144	Nabagram Golokmuni Hospital & Sarala Matri Sadan,	Nabagram Hospital Road, Nabagram, Hooghly	20	PVT	N.HOME	
145	New Life Nursing Home	Vii. & P.O.: Seakhala, Hooghly	20	PVT	N.HOME	
146	Nilkantha Diagnostic Research Center	B. T. C, Road, Tarakeswar Hooghly	20	PVT	N.HOME	
147	S.E. Nursing Home,	Baniapur Road, P.O. Arambagh.	20	PVT	N.HOME	
148	Seva Nursing Home	Vill. & P.O.: Rajbolhat, Jangipara, Hooghly	20	PVT	N.HOME	
149	Spandan Health Point	Link Road, Arambagh, Hooghly	20	PVT	N.HOME	
150	X - Ray & Surgical Clinic	Basudevpur, Arambagh, Hooghly	20	PVT	N.HOME	

DISTRICT WISE LIST OF BEDDED HCUs IN WEST BENGAL

INVENTORY: ANNEXURE - I

Sl. No	Name of the Units.	Address	Current Bed	Organisation	Category General	Category Special
151	Nivedita Community Care Centre	Ichapur, P.O.:Gopinagar, P.S.: Dhaniakhali, Hooghly	16	PVT	N.HOME	
152	A.B. Nursing Home,	Alam Market, Natun Bazar, P.O. Arambagh, Hooghly.	15	PVT	N.HOME	
153	Bagbazar Nursing Home,	Bagbazar, P.O. Chandannagar.	15	PVT	N.HOME	
154	C. C. Nursing Home	P.O. & P. S.: Arambagh, Hooghly	15	PVT	N.HOME	
155	J. N. B. Nursing Home	Bharat Rice Mill, P.O.: Pandua, Hooghly	15	PVT	N.HOME	
156	Jeevan Deep Seva Sadan,	Vill. & P.O. Kamarkundu.	15	PVT	N.HOME	
157	Matri Seva Sadan	Vill.: Borainew Tematha, Borai, Hooghly	15	PVT	N.HOME	
158	Nalikul Nursing Home	Nawpara, Nalikul, Hooghly	15	PVT	N.HOME	
159	Park Medicare & Research Centre Pvt. Ltd.	30A / 148, Dr. P. T. Laha Street, Rishra, Hooghly	15	PVT	N.HOME	
160	Santi Niketan	Mogra Tribeni Road, Mogra, Hooghly	15	PVT	N.HOME	
161	Serampore Surgical Nursing Home (P) Ltd.,	8A, K.M.Sha Street, P.O. Serampore.	15	PVT	N.HOME	
162	Seva Sadan	2, Nonadanga Road, Sheoraphully, Hooghly	15	PVT	N.HOME	
163	Srirampur Surgical Nursing Home (P) Ltd.	8, A.K.M. Sha Street, Srirampur, Hooghly	15	PVT	N.HOME	
164	Sudip Chakraborty Hospital Pvt. Ltd.	Nandanpur, Hooghly	15	PVT	N.HOME	
165	Swastha Nivas Nursing Home,	Vill. Kismat Apurbapur, P.O. Singur.	15	PVT	N.HOME	
166	The Saviour Nursing Home,	119, G.T.Road, Babur Bazar, P.O. Telinipara.	15	PVT	N.HOME	
167	United Nursing Home Pvt. Ltd.	10/B, Acharya R.C. Bhattacharjee Street, P.O. Serampore, Hooghly	15	PVT	N.HOME	
168	Upasam Medicare & Research Centre Pvt. Ltd.,	73/1, Arabinda Road, Konnagore, Hooghly	15	PVT	N.HOME	
169	New Florida Nursing Home	2, Nonadanga Road, Sheoraphully, Hooghly	14	PVT	N.HOME	
170	Surgical Nursing Home	8, K.M. Sha Street, Serampore, Hooghly	14	PVT	N.HOME	
171	Bankrishnapur Janashree Sangha,	Singur, Hooghly	13	PVT	N.HOME	
172	Ananda Ashram Nursing Home	Radhakridshnapur, Rajhati Bandar, Hooghly	10	PVT	N.HOME	
173	Anandamoyee Nursing Home	Vill.: Ajodhya P.O.: Jangipara Hooghly	10	PVT	N.HOME	
174	Ananta Ayurvedic Trust	Kanaipur, Nayapara, Konnagar, Hooghly	10	PVT	N.HOME	
175	Appolo Nursing Home,	Bhagabatipur Bazar Road, Fancy Market, P.O. Chanditala.,	10	PVT	N.HOME	
176	Arunodaya Health Care	Lichubagan, P.O.: Garalgacha. P.S.: Dankuni, Hooghly.	10	PVT	N.HOME	
177	B.C.Dey Memorial Maternity & Child Welfare Centr,	Vill. Rampara, P.O. Dakshindihi.	10	PVT	N.HOME	
178	Bela Nursing Home	Chanditala, Hooghly	10	PVT	N.HOME	
179	Bhairab Seva Sadan	Kismat Apurbapur, Singur, Hooghly	10	PVT	N.HOME	
180	Bistu Charan Dey Memorial Maternity & Child Welfare Center	Vill.: Rampara, Dakshindihi, Hooghly	10	PVT	N.HOME	
181	Care Nursing Home	23, Lenin Sarani, P.O.: Serampore, Hooghly	10	PVT	N.HOME	
182	Careland Nursing Home Pvt. Ltd.,	G.T.Road, Kantapukur, P.O. Mogra.	10	PVT	N.HOME	

DISTRICT WISE LIST OF BEDDED HCUs IN WEST BENGAL

INVENTORY: ANNEXURE - I

Sl. No	Name of the Units.	Address	Current Bed	Organisation	Category General	Category Special
183	Chandannagar Nursing Home,	Laldighirdhar, G.T.Road, P.O.Chandannagar.	10	PVT	N.HOME	
184	Chandannagore Maternity & Nursing Home,	Barabazar, P.O. Chandannagore.	10	PVT	N.HOME	
185	Chhaya Seva Sadan	P.O.: Morakhana, Hooghly	10	PVT	N.HOME	
186	Das Gupta Velorem Clinic	55, Bandel Station Road, P.O.: Bandel, Hooghly	10	PVT	N.HOME	
187	Debabrata Medicare & Diagnostic Center	3, Station Road, Nabagram, Hooghly	10	PVT	N.HOME	
188	Diamond Eye O Health Care Society	Pandua Kalna Road, Pandua, Hooghly	10	PVT	N.HOME	
189	Dibyalok Nursing Home (P) Ltd.,	Station Road, P.O. Gurap, (Balidaha).	10	PVT	N.HOME	
190	Ghosh's Nursing Home,	Court Road, Near Bus Stand, P.O. Arambagh	10	PVT	N.HOME	
191	Green Land Nursing Home & Poly Clinic,	Makarkundu (Near Post Office).	10	PVT	N.HOME	
192	Happy Home (Nursing Home),	P.O. Arambagh.	10	PVT	N.HOME	
193	Hi-Tech Care Center	66/K, Pravash Nagar, Serampore, Hooghly	10	PVT	N.HOME	
194	Ideal Nursing Home,	G.T.Road, Kantapukur, P.O. Mogra.	10	PVT	N.HOME	
195	Jiban Deep Nursing Home	Miyapara, P.O. & P.S.: Arambagh, Hooghly	10	PVT	N.HOME	
196	Jiban Nursing Home,	Vill. Paschimpara, P.O. Nimdangi., Hooghly	10	PVT	N.HOME	
197	Jiban Suroksha Seva Sadan	Pursurah, Hooghly	10	PVT	N.HOME	
198	Kanak Nursing Home	1, Netaji Park, G.T.Road, P.O. Bandel.	10	PVT	N.HOME	
199	Kanak Seva Sadan,	Gourhati Road, P.O. & P.S.: Arambagh, Hooghly	10	PVT	N.HOME	
200	Lions Gramin Seva Kendra	Bahirkhand, Hooghly	10	PVT	N.HOME	
201	Maa Ananda Moyee Nursing Home	Jangipara, Hooghly	10	PVT	N.HOME	
202	Midland Nursing Home,	Pipulpati, P.O. Hooghly.	10	PVT	N.HOME	
203	Mother's Home (Nursing Home),	203, Bhudeb Mukherjee Road, P.O. Chandannagar, Hooghly	10	PVT	N.HOME	
204	Motherland Nursing Home,	Vill. & P.O. Dankuni.	10	PVT	N.HOME	
205	Nabadiganta Nursing Home,	Barijhatti, P.O. Chanditala, Hooghly	10	PVT	N.HOME	
206	Naboday Nursing Home,	P.O. -Khanakul., Arambagh, Hooghly	10	PVT	N.HOME	
207	New Ideal Nursing Home,	G.T.Road, Tematha, P.O. Chandannagar, Hooghly	10	PVT	N.HOME	
208	New Life Nursing Home,	Barizhati, Vill & P.O. Chanditala, Hooghly	10	PVT	N.HOME	
209	Nibedita Nursing Home,	Near Arambagh Bus Stand, P.O. Arambagh, Hooghly	10	PVT	N.HOME	
210	Pankajini Nursing Home,	Vill. Sripatipur, P.O. Seakhala, Dankuni, Hooghly	10	PVT	N.HOME	
211	Park Nursing Home	Pallishree, P.O.: Arambagh, Hooghly	10	PVT	N.HOME	
212	Physical Medicine Center	Block Para, Arambagh, Hooghly	10	PVT	N.HOME	
213	Pratham Alo Eye Care Centre	Dankuni, Hooghly.	10	PVT	N.HOME	
214	Ramkrishna Mission Pallimangal (Eye Care)	Kamarpukur, Hooghly	10	PVT	N.HOME	

DISTRICT WISE LIST OF BEDDED HCUs IN WEST BENGAL

INVENTORY: ANNEXURE - I

Sl. No	Name of the Units.	Address	Current Bed	Organisation	Category General	Category Special
215	Ruby Nursing Home	Barijhatti, Chanditala, Hooghly	10	PVT	N.HOME	
216	Sabitri Memorial Nursing Home	Jangipara, Hooghly	10	PVT	N.HOME	
217	Sefa Nursing Home,	Vill & P.O. Sheakhala, P.S.: Chanditala, Hooghly	10	PVT	N.HOME	
218	Seth Clinic	Barabazar, Chandernagar, Hooghly	10	PVT	N.HOME	
219	Seva Niketan Nursing Home	T.N. Mukherjee Road, Dankuni, Hooghly	10	PVT	N.HOME	
220	Sri Krishno Nursing Home	Vill.: Dakshin Rasulpur, Kable, Hooghly	10	PVT	N.HOME	
221	Sur Clinic & Nursing Home,	217, S.C. Mukherjee Road, P.O. Hooghly.	10	PVT	N.HOME	
222	Ananda Nursing Home,	119, Raja Peary Mohan Road, P.O. & P.S.: Uttarpara, Hooghly.	9	PVT	N.HOME	
223	Ideal Nursing Home,	Tematha, P.O. Chandannagore.	9	PVT	N.HOME	
224	Nabajiban Nursing Home	Vill. & P.O.: Hasali, Arambagh, Hooghly	9	PVT	N.HOME	
225	Das Gupta Nursing Home,	25, Sadhan Kanan Block, K.C.Sen Road, P.O. Rishra.	8	PVT	N.HOME	
226	Hooghly Nursing Home,	Ramkrishna Lane, Pipulpati, P.O. Hooghly.	8	PVT	N.HOME	
227	Sen's Clinic	Bagbazar, Chandernagar, Hooghly	8	PVT	N.HOME	
228	Serampore Clinic & Nursing Home,	2B, Burobibi Lane, P.O. Serampore.	8	PVT	N.HOME	
229	Arogya Nursing Home	Vill. & P.O.: Pursurah, Hooghly	6	PVT	N.HOME	
230	Astha Nursing Home	Vill.: Ahmedpur Hospital Road, Patuligarh	6	PVT	N.HOME	
231	Maa Kali Arogya Niketan Nursing Home	Vill. & P.S.: Sabal Singhapur, P.S.: Khanakul, Hooghly	6	PVT	N.HOME	
232	Narcissus Medical Centre,	12, Dr. G.C. Goswami Street, P.O. Serampore.	6	PVT	N.HOME	
233	Pandua Nursing Home	Alam Market, Pandua, Hooghly.	6	PVT	N.HOME	
234	Sunayan Eye Clinic & Microsurgery Centre	32B, N.N.B Sarani, Uttarpara, Hooghly	6	PVT	N.HOME	
235	Ushapati Bhagabati Nursing Home	Chhatrasal, Ghoal, Hooghly	6	PVT	N.HOME	
236	Eye Care & Lens Clinic Nursing Home,	2A, Sadgope Para Lane, Mahesh, Serampore – 2, P.O. Serampore.	5	PVT	N.HOME	EYE
237	Eye Micro Surgery Loser Clinic	Barabazar, Chinsurah, Hooghly	5	PVT	N.HOME	EYE
238	Netra Deep Eye Care Centre,	153/1, Netaji Subhas Avenue, P.O. & P.S.: Serampore, Hooghly	5	PVT	N.HOME	EYE
239	New Light Eye Clinic,	Melatala, P.O. Pandua, Hooghly	5	PVT	N.HOME	EYE
240	Arambagh Phaco Center	Arambagh, Hooghly	5	PVT	N.HOME	
241	Baidyabati Nursing Home,	1/1A, Raja Rammohan Sarani, P.O. Baidyabati.	5	PVT	N.HOME	
242	Bimala Surgical Nursing Home	79/1/C, Lalbahadur Sastri Road, P.O.: Konnagar, Hooghly	5	PVT	N.HOME	
243	Bose Eye Micro Surgery & Laser Centre	Bara Bazar, Chinsura, Hooghly	5	PVT	N.HOME	
244	Das Nursing Home,	Vill. Jangalpara, P.O. Jangalpara Bazar.	5	PVT	N.HOME	
245	DEEP Nursing Home	Dongal, Dharkundy, Arambagh, Hooghly	5	PVT	N.HOME	
246	Divine Nursing Home,	1/3/1, Goswami Bagan Lane, P.O. Sheoraphuli, Hooghly	5	PVT	N.HOME	

DISTRICT WISE LIST OF BEDDED HCUs IN WEST BENGAL

INVENTORY: ANNEXURE - I

Sl. No	Name of the Units.	Address	Current Bed	Organisation	Category General	Category Special
247	Dr. Ghosh's Nursing Home,	1/4, Goswami Bagan Lane, P.O. Sheoraphuli.	5	PVT	N.HOME	
248	Dr. Rama's Nursing Home,	87/15A, N.K. Banerjee Street, Rishra	5	PVT	N.HOME	
249	Dr. Sen's Clinic,	Kuthirmath, P.O. Chandannagar.	5	PVT	N.HOME	
250	Dreamland Nursing Home	Augur Son More, Pindira, P.S.: Balagarh, Hooghly	5	PVT	N.HOME	
251	Dristanta	60/A/33, H.C. Banerjee Lane, P.O. Konnagar, Hooghly	5	PVT	N.HOME	
252	G. M. C. Nursing Home	Monoharpur, Dankuni, Hooghly	5	PVT	N.HOME	
253	Ganga Nursing Home,	Vill: Krishnanagar, P.O. Jangipara.	5	PVT	N.HOME	
254	Happy Clinic	3,Old Court Road, Serampore Hoghly	5	PVT	N.HOME	
255	Health Point Nursing Home & Eye Care Centre,	167, Ferry Ghat Station Babubazar, P.O. Telinipara.	5	PVT	N.HOME	
256	ITC Limited (Medical Unit)	Chandrahati, Hooghly	5	PVT	N.HOME	
257	Jeevan Deep Nursing Home	263/1, G. T. Road, Baidyabati, Hooghly	5	PVT	N.HOME	
258	Jibak Polyclinic Maternity Cum Nursing Home,	1B, Desh Bandhu Road, P.O. Nabagram.	5	PVT	N.HOME	
259	Kamarpukur Nursing Home,	Vill. Sripur, P.O. Kamarpukur, Hooghly	5	PVT	N.HOME	
260	Life Line Nursing Home	Nawabpur, Chanditala, Hooghly	5	PVT	N.HOME	
261	Lifecare- General Nursing Home,	61, Ferry Ghat Street, Baburbazar, P.O. Telinipara, Hooghly	5	PVT	N.HOME	
262	Link Road Nursing Home,	Link Road, P.O. Arambagh.	5	PVT	N.HOME	
263	Little Nursing Home	7/A, M.G. Road, Serampore, Hoghly	5	PVT	N.HOME	
264	Maya Roy Seva Sadan & Training Institute	Chhatrasal, Ghoal, Hooghly	5	PVT	N.HOME	
265	Mini Med Nursing Cum Maternity Home,	Hospital Road, Jirat, Vill. Ahmedpur P.O. Patuligram.	5	PVT	N.HOME	
266	New Life Nursing Home, (Maternity Only)	49/44-45, Rabindra Sarani, Rishra, Hooghly	5	PVT	N.HOME	
267	Niharika Nursing Home,	49, Dharapara, P.O. Chandannagar.	5	PVT	N.HOME	
268	Punarnetra Eye Care & Surgical Nursing Home	164/2, Thakurbati Station, Serampore, Hooghly	5	PVT	N.HOME	
269	Ramkrishna Seva Sadan,	P.O. Arambagh., Hooghly	5	PVT	N.HOME	
270	Samui Seva Sadan	Vill & P.O.: Nandanpur, P.S.: Khanakul, Hooghly	5	PVT	N.HOME	
271	Saradamayee Seva Niketan,	Vill & P.O. Mandra.	5	PVT	N.HOME	
272	Sebayab	Chakrabortypara, P.O.: Chandernagore, Hooghly	5	PVT	N.HOME	
273	Sebayan,	Barasat, P.O. Chandernagore.	5	PVT	N.HOME	
274	Seva (Nursing Home)	Rajbalhat, Puratan Hattala, Hooghly	5	PVT	N.HOME	
275	Seva Niketan	Vill.: Gobra, P.O.: Chanditala, P.S.: Dankuni, Hooghly	5	PVT	N.HOME	
276	Seva Nursing Home & Neuro Phychiatric Research Clinic	2, Settlane, Bhadreswar, Hooghly	5	PVT	N.HOME	
277	Sevasadan Nursing Home	Sipaigachi, P.O.: Charpur, P.S.: Haripal, Hooghly	5	PVT	N.HOME	
278	Singur Maternity Home,	420/1, Singur Bazar, P.O. Singur.	5	PVT	N.HOME	

DISTRICT WISE LIST OF BEDDED HCUs IN WEST BENGAL

INVENTORY: ANNEXURE - I

Sl. No	Name of the Units.	Address	Current Bed	Organisation	Category General	Category Special
279	Srirampur Matrisadan,	17, Rai M.C. Lahiri Bahadur Street, Neel Jheel Apartment, Srirampore,	5	PVT	N.HOME	
280	Star Research Clinic Cum Nursing Home,	24/A/1, Vivekananda Palli, Tarakeswar.	5	PVT	N.HOME	
281	Sunayan Eye Care & Surgery,	Chuchura Station Road, P.O. Chinsurah.	5	PVT	N.HOME	
282	Suraksha Nursing Home	Mrigala Kalipur, Dankuni, Hooghly	5	PVT	N.HOME	
283	The Care (Uttarpara Nursing Home),	27/T, R.K. Street, Uttarpara.	5	PVT	N.HOME	
284	Vivekananda Orthopedic Centre	Padmapukur More, Tarakeswar, Hooghly	5	PVT	N.HOME	
285	Appolo Nursing Home,	Vill: Sripatipur, P.O.: Sheakhala, P.S.: Haripal, Dist.: Hooghly	4	PVT	N.HOME	
286	Janakalyan Nursing Home,	27, R.N.Neogi Lane, P.O. Bhadreswar.	4	PVT	N.HOME	
287	Pujari Nursing Home	1/1A, Bullah Mia Road, Rishra, Hooghly	4	PVT	N.HOME	
288	Red Cross Maternity Home	Srirampore (M), P.O. Nabagram, Hooghly	4	PVT	N.HOME	
289	Chandannagore Ocular Clinic (Nursing Home),	208, Bhudeb Mukherjee Road, P.O.Chandannagore.	3	PVT	N.HOME	
290	D. M. C. Netralaya	Sheakhala Bazar,, Sheakhala, Hooghly	3	PVT	N.HOME	
291	D.K. Nursing Home,	P.O. Champadanga (Rathtala).	3	PVT	N.HOME	
292	D.K. Nursing Home,	P.O. Champadanga (Rathtala).	3	PVT	N.HOME	
293	Jyotirmoyee Arogya Bhawan	Vill & PO. Sheakhala, Hooghly	3	PVT	N.HOME	
294	Maa Nursing Home	Serampore, Hooghly	3	PVT	N.HOME	
295	Angel E.N.T. Clinic,	2/C, Raja Peary Mohan Road, Uttarpara.	2	PVT	N.HOME	
296	Das Clinic & Maternity	19, S. C. Dey Lane, Konnagar, Hooghly	2	PVT	N.HOME	
297	Ghosh Clinic	Vill. & P.O. Haripal, Hooghly	2	PVT	N.HOME	
298	Life Clinic	Champadanga, Cinematala, P.O.: Champadanga, Hooghly	2	PVT	N.HOME	
299	Maa Tara Nursing Home	2/2, F.G. St. Talinipara, Hooghly	2	PVT	N.HOME	
300	Maternity & Diagnostic Clinic	Babu Bazar, G.T. Road, PO Telinipara, Dist. Hooghly	2	PVT	N.HOME	
301	Mukti Clinic,	Kamarkundu Old Market, P.O. Singur.	2	PVT	N.HOME	
302	Niramoy Clinic,	203/C/2, Rajendra Avenue, P.O. & P.S. Uttarpara.	2	PVT	N.HOME	
303	Relief Nursing Home	586 (170/1), G. T. Road, P.O.: Baidyabati, Hooghly	2	PVT	N.HOME	
304	Taj Clinic	1(1/4), Goswami Bagan Lane, P.O. Sheoraphuli.	2	PVT	N.HOME	
305	Tulsi Seva Niketan	Halen, Khanakul, Hooghly	2	PVT	N.HOME	
		TOTAL NUMBER OF BEDS IN HOOGHLY DISTRICT:	6713			

DISTRICT WISE LIST OF BEDDED HCUs IN WEST BENGAL

INVENTORY: ANNEXURE - I

Sl. No	Name of the Units.	Address	Current Bed	Organisation	Category General	Category Special
HOWRAH						
1	Howrah District Hospital	Howrah (MC), P.O. Howrah, Howrah	544	GOVT	DH	
2	S.D. Hospital – Uluberia	Uluberia (M), P.O. & P.S. Uluberia, Howrah, PIN- 711 316	210	GOVT	SD	
3	Tulsiram Lakshmi Devi State General Hospital	252, G. T. Road, Bally (M), P.O. Liluah, Howrah	260	GOVT	SG	
4	Gabberia State General Hospital	Panchla (B), P.O. Gabberia, Howrah	118	GOVT	SG	
5	Udaynarayanpur State General Hospital	P.O. Udaynarayanpur, Howrah	60	GOVT	SG	
6	Fort Gloster State General Hospital	P.O. Bauria, Uluberia, Howrah	50	GOVT	SG	
7	South Howrah State General Hospital	College Ghat Road, Vill. Laxminarayantala, Botanic Garden, Howrah - 3	30	GOVT	SG	
8	Belur State General Hospital	40, Belur Station Road, P.O. Belurmath, Bally, Howrah- 711202	10	GOVT	SG	
9	Mohiary Lakshmi Kamal Hosptial	P.O. Andul-Mouri, Howrah	10	GOVT	SGH	
10	Baltikuri M.C.W. (Kedarnath)	Baltikuri Bazar, How - 13	6	GOVT	SGH	
11	Jagatballavpur Rural Hospital	P.O. Jagatballavpur, Dist. Howrah, PIN. 711408	60	GOVT	RH	
12	B. B. Dhar Rural Hospital, (Amraguri)	Amta - II, P.O. Amraguri, Howrah	50	GOVT	RH	
13	Bagnan Rural Hospital	P.O. Bagnan, Howrah- 711303	40	GOVT	RH	
14	Amta Rural Hospital	P.O. Amta, Amta - I, Howrah - 711 401	30	GOVT	RH	
15	Domjur Rural Hospital	P.O. Domjur, Howrah	30	GOVT	RH	
16	Jhumjhumi Rural Hospital	P.O. Jhumjhumi, Shyampur-II, Dist. Howrah	30	GOVT	RH	
17	Jagadishpur (Kona) BPHC	Jagacha, P.O. Kona, Howrah	15	GOVT	BPHC	
18	Joypur BPHC	P.O. Joypur, Howrah- 711101	15	GOVT	BPHC	
19	Kamalpur BPHC	Vill. Kamalpur, P.O. Radhapur, PS. Shyampur, Dist. Howrah	15	GOVT	BPHC	
20	S.T. Mallick (Sankrail) BPHC	P.O. Sankrail, Howrah	15	GOVT	BPHC	
21	Brindabanpur BPHC	P.O. Brindabanpur, Uluberia, Dist. Howrah	10	GOVT	BPHC	
22	Chandipur-Manickpur BPHC	P.O. Kulgachia, Uluberia, Howrah	10	GOVT	BPHC	
23	Debipur (Pancharul) BPHC	P.O. Pancharul, Howrah	10	GOVT	BPHC	
24	Kulai BPHC	P.O. Panchla, Howrah	10	GOVT	BPHC	
25	Mugkalyan BPHC	Bagnan, 11 Block, Vill & PO. Mugkalyan, Howrah	10	GOVT	BPHC	
26	Harishpur PHC	P.O. Penro, Howrah	14	GOVT	PHC	
27	Bargachia PHC	P.O. Bargachia, Howrah	10	GOVT	PHC	
28	Basantapur PHC	P.O. Mate, Howrah	10	GOVT	PHC	
29	Deulpur PHC	P.O. Deulpur, Howrah	10	GOVT	PHC	
30	Jhikhira PHC	P.O. Kankrala, Howrah	10	GOVT	PHC	
31	Khosalpur PHC	P.O. Anulia, Howrah	10	GOVT	PHC	

DISTRICT WISE LIST OF BEDDED HCUs IN WEST BENGAL

INVENTORY: ANNEXURE - I

Sl. No	Name of the Units.	Address	Current Bed	Organisation	Category General	Category Special
32	Majur PHC	P.O. Majur, Howrah	10	GOVT	PHC	
33	Nabagram PHC	Nabagram-Sikipur, Howrah	10	GOVT	PHC	
34	Pantihal PHC	P.O. Pantihal, Howrah	10	GOVT	PHC	
35	Purpat PHC	P.O. Purpat, Howrah	10	GOVT	PHC	
36	Rashpur PHC	P.O. Rashpur, Howrah	10	GOVT	PHC	
37	Sankarhati PHC	P.O. Munshirhat, Howrah	10	GOVT	PHC	
38	Adra PHC	P.O. Bangalpur, Howrah	6	GOVT	PHC	
39	Amardaha PHC	P.O. Amardaha, Howrah	6	GOVT	PHC	
40	Bakurdah PHC	Bagnan - II, P.O.: Bakurdah, Howrah	6	GOVT	PHC	
41	Bankra PHC,	P.O. Bankra, Howrah	6	GOVT	PHC	
42	Bantul PHC	P.O. Kulitopara, Howrah	6	GOVT	PHC	
43	Bara Garh Chumuk PHC	Shyampur - II, P.O.: Bara Garh Chumuk, Howrah	6	GOVT	PHC	
44	Dakshinkhalna PHC	P.O. Khalna, Howrah	6	GOVT	PHC	
45	Garh Bhawarnipur PHC	P.O. Chitrasenpur, Howrah	6	GOVT	PHC	
46	Jagacha PHC	P.O. Jagacha, Howrah	6	GOVT	PHC	
47	Pichaldah PHC	P.O. Baneswarpur, Howrah	6	GOVT	PHC	
48	Tulshiberia PHC	P.O. Tulsiberia, Howrah	6	GOVT	PHC	
49	Bally PHC	P.O. Ghoshpur, Howrah	4	GOVT	PHC	
50	Banharishpur PHC	P.O. Jalabiswanathpur, Howrah	4	GOVT	PHC	
51	Baraberia PHC	P.O. Somrup, Howrah	4	GOVT	PHC	
52	Basudevpur PHC	P.O. Basudevpur, Howrah	4	GOVT	PHC	
53	Belgachia PHC	P.O. Dasnagar, Howrah	4	GOVT	PHC	
54	Dhulasimla PHC	P.O. Dhulasimla, Howrah	4	GOVT	PHC	
55	Dihibhursat PHC	P.O. Rampur, Howrah	4	GOVT	PHC	
56	Gajipur PHC	P.O. Gajipur, Howrah	4	GOVT	PHC	
57	Gobindapur PHC	P.O. Naskarpur, Howrah	4	GOVT	PHC	
58	Kalorah PHC,	P.O. Kalorah, Howrah	4	GOVT	PHC	
59	Mankar PHC	P.O. Mankar, Howrah	4	GOVT	PHC	
60	Nonakundu PHC	P.O. Nonakundu, Howrah	4	GOVT	PHC	
61	Palgustia PHC	P.O. Palgustia, Howrah	4	GOVT	PHC	
62	Raghudevhati (Monoharpur) PHC	P.O. Raghudevhati, Howrah	4	GOVT	PHC	
63	Kendua PHC	P.O. Kendua, Howrah	2	GOVT	PHC	

DISTRICT WISE LIST OF BEDDED HCUs IN WEST BENGAL

INVENTORY: ANNEXURE - I

Sl. No	Name of the Units.	Address	Current Bed	Organisation	Category General	Category Special
64	Paschim Bainan PHC	P.O. Bainan, Howrah	2	GOVT	PHC	
65	Rampara PHC	P.O. Amta, Howrah	2	GOVT	PHC	
66	South Bhatora PHC	P.O.. Bhatora, Howrah	2	GOVT	PHC	
67	Satya Bala Devi I.D. Hospital	P.O. Howrah, Howrah	52	GOVT	ID	ID
68	B.E. College Hospital	P.O. B. Garden, Howrah	24	GOVT	SGE	
69	Howrah Jail Hospital	P.O. Howrah, Howrah	6	GOVT	SGJ	
70	Uluberia E.S.I. Hospital	Uluberia (MC), P.O. Uluberia, Howrah	216	GOVT	SGL	
71	Baltikuri E.S.I. Hospital	P.O.: Bankra, Baltikuri, Howrah	200	GOVT	SGL	
72	Belur E.S.I. (T.B.) Hospital	Sapuipara, P.O. Belur Math, Howrah	200	GOVT	SGL	
73	Howrah Police Hospital	P.O. Shibpur, Howrah	104	GOVT	SGP	
74	Howrah Orthopaedic Hospital – Eastern Railway,	222, Biplabi Haren Ghosh Sarani, P.O. Howrah, Howrah - 1	179	GOVT	RLY	
75	Eastern Rly. Hospital, Liluah	P.O. Liluah, Howrah	101	GOVT	RLY	
76	Kedar Nath Arogya Bhawan	P.O. Bally, Howrah	35	GOVT	MUNI	
77	Silverjubily Dispensary & Matrisadan (Bally Municipal)	30, Rabindra Sarani, Lilua Howrah	19	GOVT	MUNI	MNTY
78	Maternity Home (Uluberia Municipality)	Uluberia Municipality, Bazarpara, Uluberia	10	GOVT	MUNI	MNTY
79	Casual Vagrant Home	P.O. Howrah, Howrah	18	GOVT	SGV	
80	West Bank Hospital	Andul Road, P.O. Podra, Howrah – 711 109	150	PVT	N.HOME	
81	Shree Jain Hospital & Research Centre,	493 B/12, G.T. Road (S), Shibpur, Howrah	115	PVT	N.HOME	
82	Bally Jana Sevayatan,	123, G.T. Road, Bally, Howrah	50	PVT	N.HOME	
83	Howrah T.B. Hospital	Danesh Sekh Lane, P.O. Howrah, Howrah	48	PVT	N.HOME	TB
84	Bally Kedernath Arogya Bhavan	90, G.T. Road, P.O. Bally, Howrah – 711 201	43	PVT	N.HOME	
85	St.Thomas Home	158, Bellilious Road, Bantra, Howrah-101	42	PVT	N.HOME	
86	Apanjan Nursing Home Pvt. Ltd.	Makardan, Amta Road, Howrah	40	PVT	N.HOME	
87	Howrah Lions Hospital	9, Nityadhan Mukherjee Road, How - 711 101	40	PVT	N.HOME	
88	Alpha Nursing Home & Children Centre	21/1, Dobson Road, Howrah	35	PVT	N.HOME	
89	Astha Medical Center	121/95-98, J. N. Mukherjee Road Ghusuri, Howrah	35	PVT	N.HOME	
90	Howrah South Point Pushpa Children Home	P-249, Andul Road, Vill.: Halder Para, P.O.: D. S. Lane, Howrah	30	PVT	N.HOME	
91	MATRI Sangha Hospital	116, Raj Ballav Saha Lane, Howrah - 01	30	PVT	N.HOME	
92	Medicare Clinic & Research Center Pvt. Ltd.	138, G. T. Road (South), How - 2	30	PVT	N.HOME	
93	Netai Charan Homeopathic Medical College & Hospital	45'F' Road, Belgachia, Howrah	30	PVT	N.HOME	
94	People's Meditreat. Pvt. Ltd.	262 Netaji Subhas Bose Road, How - 711 101	30	PVT	N.HOME	
95	Bansal Nursing Home	20, Dobson Road, Howrah	25	PVT	N.HOME	

DISTRICT WISE LIST OF BEDDED HCUs IN WEST BENGAL

INVENTORY: ANNEXURE - I

Sl. No	Name of the Units.	Address	Current Bed	Organisation	Category General	Category Special
96	Hac India Limited (Medical Division)	Vill. & P.O.: Raghudevapur, Block - II, P.S.: Uluberia, Howrah	25	PVT	N.HOME	
97	Sister Nibedita Hospital	Mohini Complex, Bazarpara, Uluberia, Howrah	25	PVT	N.HOME	
98	Benuban Healthcare & Diagnostic Center	Baltikuri, japani Gate, Howrah	20	PVT	N.HOME	
99	Care & Cure Nursing Home	Bazarpara, Uluberia, Howrah	20	PVT	N.HOME	
100	Debsishu Nursing Home Pvt. Ltd.,	40, Dobson Road, Howrah	20	PVT	N.HOME	
101	Indus Nursing Home	Andul Road Podhra Howrah - 09	20	PVT	N.HOME	
102	National Nursing Home	Bazarpara, Uluberia, Howrah	20	PVT	N.HOME	
103	Tarama Nursing Home	Uluberia, Bazar Para, Howrah	20	PVT	N.HOME	
104	Treat Well Nursing Home	Uluberia Station Road (S), P.O. Uluberia, Howrah	20	PVT	N.HOME	
105	Ideal Nursing Home	Bazarpara, Uluberia, Howrah – 711 316	16	PVT	N.HOME	
106	Swastik Nursing Home	Vill. & P.O. Gobindapur, shyampur, Howrah	16	PVT	N.HOME	
107	Belur Shramajibi Swastha Prkalpa Samity	5/1, G.T. Road, Howrah	15	PVT	N.HOME	
108	Howrah Nursing Home	80/1, Chintamoni Dey Road, Howrah - 1	15	PVT	N.HOME	
109	Jeebak Nursing Home	Shibrampur, P.O.: Bargachia, Howrah	15	PVT	N.HOME	
110	Life Care Nursing Home	185, G.T. Road (S), Shibpur, Howrah - 2	15	PVT	N.HOME	
111	New Eden Nursing Home	Bazarpara, Uluberia, Howrah	15	PVT	N.HOME	
112	S.C. Bagchi Aragya Sadan & Research Institute Pvt. Ltd.,	43/5, Ram Charan Seth Road, Howerah - 4	15	PVT	N.HOME	
113	Mandelia Maternity & Nursing Home	285/1, G.T. Road (S), Shibpur, Howrah	14	PVT	N.HOME	
114	Sun Flower Nursing Home	266/4, G.T. Road, Liluah, Howrah	14	PVT	N.HOME	
115	Sreema Nursing Home	Amta Old B.D.O. and near Public Libray, Amta, Howrah	12	PVT	N.HOME	
116	Baluhati Rural Devolpment & Charitable Trust	Baluhati, Howrah	10	PVT	N.HOME	
117	Bivek Nursing Home	63 G. T. Road (North), How - 1	10	PVT	N.HOME	
118	Blue Bell Nursing Home	157, 'K' Andul Chowdhury Para, P.O.Andul Mouri, Howrah	10	PVT	N.HOME	
119	Blue View Seva Sadan	Uluberia Bazarpara, Howrah – 711 315	10	PVT	N.HOME	
120	Day Night Nursing Home	Bazarpara, Uluberia, Howrah	10	PVT	N.HOME	
121	Dewanti Nursing Home	281/27/A/2, G.T. Road, Liluah, Howrah	10	PVT	N.HOME	
122	Dolphin Nursing Home	Uluberia, Bazar Para, Howrah	10	PVT	N.HOME	
123	Domjur Nursing Home	P.O. & P.S.: Domjur, Howrah	10	PVT	N.HOME	
124	Eden Maternity & Nursing Home	Vill. & P.O. Nabaghara, P.S. Shankrail, Howrah	10	PVT	N.HOME	
125	Harekrishna Nursing Home	304, G. T. Road (N), Howrah - 06, Salkia	10	PVT	N.HOME	
126	Harhar Polyclinic	Salkia, Howrah	10	PVT	N.HOME	
127	Hazra Nursing Home	P.O. & P.S. Domjur, Howrah-711405	10	PVT	N.HOME	

DISTRICT WISE LIST OF BEDDED HCUs IN WEST BENGAL

INVENTORY: ANNEXURE - I

Sl. No	Name of the Units.	Address	Current Bed	Organisation	Category General	Category Special
128	Howrah South Point Social Welfare & Community Development	32, P.M. Batsee, 3rd Bye Lane, Shibpur, Howrah - 711102	10	PVT	N.HOME	
129	Islamia Nursing Home	Vill.: Amta Sirajbati, P.O.: Amta, Howrah	10	PVT	N.HOME	
130	Jeevan Jyoti Nursing Home	2C, N.S. Road, Liluah, Howrah	10	PVT	N.HOME	
131	Jiban Deep Nursing Home	Bazarpara, Uluberia, Howrah	10	PVT	N.HOME	
132	Life Care Nursing Home	Bazarpara, Uluberia	10	PVT	N.HOME	
133	M. B. Nursing Home	189, G. T. Road (South), Shibpur Howrah - 02	10	PVT	N.HOME	
134	M.K. Nursing Home	Kona, Bagpara, Howrah	10	PVT	N.HOME	
135	Manisha Nursing Home	Bikihakola, Panchla, Howrah	10	PVT	N.HOME	
136	Maria Health Center	Dakshinpally, Bankra, P.O.: Bankra, P.S.: Domjur, Howrah	10	PVT	N.HOME	
137	Matri Seva Niketan	1/3, Chowdhury Para Lane, Howrah – 711 104	10	PVT	N.HOME	
138	Mediluck Nursing Home	Uluberia Station Road, Bazarpara, Uluberia, Howrah	10	PVT	N.HOME	
139	Micro Point Nursing Home	22/A, Ghoshes Lane, (North), Belur, Howrah	10	PVT	N.HOME	
140	Mission Medical Center	Puillya, P.O.: Unsanu, P.S.: Jagacha, Howrah	10	PVT	N.HOME	
141	Modern Nursing Home	Vill. & P.O. Duila, P.S. Shankrail, Howrah –	10	PVT	N.HOME	
142	Sanjeebani Nursing Home	Vil. & P.O.: Bankra, P.S.: Domjur, Howrah	10	PVT	N.HOME	
143	Saradamayee Matri Seva Sadan	Vill.: Kurit, P.S.: Amta, Howrah	10	PVT	N.HOME	
144	Sevaland Nursing Home	Villankarhati, P.O. Munsirhat, Howrah	10	PVT	N.HOME	
145	Shaila Bala Clinic	365/1, G. T. Road (North), Salkia	10	PVT	N.HOME	
146	Singh Medicare & Research Institute	Shivpur, 263/3, G. T. Road (S), Howrah - 02	10	PVT	N.HOME	
147	Singh Nursing Home 'N' Diagnostic Center	439, G. T. Road, Howrah - 711 102	10	PVT	N.HOME	
148	Specialist's Corner Nursing Home, X-Ray & Poly Clinic	95, Salkia School Road, Salkia, Howrah - 6	10	PVT	N.HOME	
149	Swasti Nursing Home	6/1, Ghosh Lane, P.O. Belur Math, Howrah	10	PVT	N.HOME	
150	Thalassaemia Treatment & Detection Center (Indian Redcross)	50 Panchanantala Road, Howrah - 01	10	PVT	N.HOME	
151	Udaynarayanpur Matri Sadan & Poly Clinic	Udaynarayanpur, Howrah – 711 226	10	PVT	N.HOME	
152	Udit Nursing Home	50/2/1, Bhairab Dutta Lane, Salkia, Howrah- 6	10	PVT	N.HOME	
153	Upasom Nursing Home	Uluberia Station Road, Bazarpara, Uluberia, Howrah	10	PVT	N.HOME	
154	Vivek Nursing Home	63, G.T. Road, Bally, Howrah -1	10	PVT	N.HOME	
155	Watkin's Nursing Home	2, Khirode Chandra Ghosh Road, Howrah	10	PVT	N.HOME	
156	Well Care Nursing Home	Bazarpara, Uluberia, Howrah	10	PVT	N.HOME	
157	Wing Guard Nursing Home	Ichhapore Sasthi Bagan, santragachi, Howrah	10	PVT	N.HOME	
158	Gabberia Nursing Home	Vill & P.O.: Bara Gabberia, P.S.: Panchla, Howrah - 711322	9	PVT	N.HOME	
159	Sevayan Nursing Service (P) Ltd.,	Garimorojpur (Andul Road), P.O. Mashila, Howrah	9	PVT	N.HOME	

DISTRICT WISE LIST OF BEDDED HCUs IN WEST BENGAL

INVENTORY: ANNEXURE - I

Sl. No	Name of the Units.	Address	Current Bed	Organisation	Category General	Category Special
160	Health Guard Nursing Home	Bazarpara, (Panarat), UluberiaHowrah - 315	8	PVT	N.HOME	
161	Kumar Maternity Home	51/2, G. T. Road	8	PVT	N.HOME	
162	Tara Maternity Home	53, G.T. Road (N), P.O. Salkia, Howrah - 1	8	PVT	N.HOME	
163	Udaynarayanpur Sevasadan Nursing Home	Jangalpara, Udaynarayanpur, Howrah	8	PVT	N.HOME	
164	Blue View Nursing Home	Panpur More, Vill. & P.O. Jaduberia, Uluberia, Howrah	7	PVT	N.HOME	
165	Dr. Hari Hara Roy Clinic Maternity Nursing Home	16/1, Khetra Mitra Lane, Salkia, Howrah	7	PVT	N.HOME	
166	Wayside Nursing Home	Bankra, P.O. Bazarpara, Domjur, Howrah – 711 403	7	PVT	N.HOME	
167	Smt. Sarala Prova Memorial Eye Centre	169, G.T. Road (S), Shibpur, Howrah – 711 102	6	PVT	N.HOME	EYE
168	Artemis	Khan Industrial Estate, Shanpur, Das Nagar, Howrah - 05	6	PVT	N.HOME	
169	Bargachia Nursing Home	J. B. Pur, Bargachia, Howrah	6	PVT	N.HOME	
170	Day Care Centre	51, Kali Kumar Mukherjee Lane, Shibpur, Howrah	6	PVT	N.HOME	
171	Sonatala Milan Sangha Village Health Center	Vill.: Bhawanipur, P.O.: Chitrasenpur, P.S.: Udaynarayanpur, Howrah	6	PVT	N.HOME	
172	Specialist Nursing Home	Andul Road, Vill. & P.O. Dulliya, Howrah – 711 302	6	PVT	N.HOME	
173	D.B. Eye Foundation & Eye Microsurgery	138, G.T. Road (S), Shree Apartment, Block-B, Room-120, Howrah	5	PVT	N.HOME	EYE
174	Netrajyoti Eye Center	Puspa Apartment, 116/1, G. Tl. Road, P.O.: Bally, Howrah - 711 201	5	PVT	N.HOME	EYE
175	Shiny Swadha Eye Care	72, Jaliapara Lane, Howrah	5	PVT	N.HOME	EYE
176	Annapurna Nursing Home	4/7, G.T. Road, Howrah	5	PVT	N.HOME	
177	Arcadia Nursing Home Pvt. Ltd.	100, Deshpran Shasmal Road, Kadamtala, Howrah	5	PVT	N.HOME	
178	Ashoka Polyclinic & Nursing Home Pvt. Ltd.,	20/1/1, Moti Ghosh Lane, Howrah -1	5	PVT	N.HOME	
179	Bagnan J.N.S. Nursing Home and Anita clinic	Bagnan Station Road, Vill. & P.O. Bagnan, Howrah	5	PVT	N.HOME	
180	Bally Nursing Home	93/1, G.T. Road, Bally, Howrah	5	PVT	N.HOME	
181	Bankra Central Poly Clinic & Nursing Home	Kasarpara, Bankra, P.S.: Domjur, Howrah	5	PVT	N.HOME	
182	Basu Maternity	20/5, Ramcharan Sett Road, Howrah - 4	5	PVT	N.HOME	
183	Benuban Central Poly Clinic & Nursing Home	Bankra, Doltala, Howrah – 711 403	5	PVT	N.HOME	
184	Care & Cure Polyclinic cum Nursing Home	178, Belliar Road, Howrah	5	PVT	N.HOME	
185	Central Nursing Home	Amta Cinematala, P.S. Amta, Howrah	5	PVT	N.HOME	
186	Dr. Alap Hossain Nursing Home	Bankra, Howrah	5	PVT	N.HOME	
187	Eye Lab	Gitaljali Apartment, Ram Raja Tala, Ramcharan Seth Road, How-04	5	PVT	N.HOME	
188	Florance Nursing Home	1/3, P.K. Roy Chowdhury Lane, Howrah	5	PVT	N.HOME	
189	Gupta Nursing Home	11/12, Burnt Salt Gola Lane, Howrah – 1	5	PVT	N.HOME	
190	Joytirmoyee Nursing Home	60/11, Kantapukur, Bantra, Howrah	5	PVT	N.HOME	
191	Niramoy Nursing Home	58, Panchanantala Road, Howrah - 1	5	PVT	N.HOME	

DISTRICT WISE LIST OF BEDDED HCUs IN WEST BENGAL

INVENTORY: ANNEXURE - I

Sl. No	Name of the Units.	Address	Current Bed	Organisation	Category General	Category Special
192	Palview Nursing Home	1/6, Chowdhury Para Lane, Howrah	5	PVT	N.HOME	
193	Pariseba	Habib Market, Bankra, Howrah	5	PVT	N.HOME	
194	Prasenjit Nursing Home	Shyampur, Howrah	5	PVT	N.HOME	
195	Probhat Nursing Home	Uluberia Bazarpara, Howrah	5	PVT	N.HOME	
196	Rainbow Maternity Home	Kashipur, Dasnagar Howrah - 05	5	PVT	N.HOME	
197	S.K. Basu Memorial Hospital	Vill. & P.O. Banipur, P.S. Sankrail, Howrah	5	PVT	N.HOME	
198	Sebayan Nursing Home	439, G.T. Road (S), Shibpur, Howrah	5	PVT	N.HOME	
199	Sevalaya Clinic & Research Center	Radhanagar, Howrah	5	PVT	N.HOME	
200	Shivam Nursing Home	66, Sri Arabinda Road, P.O. Salkia, Howrah - 6	5	PVT	N.HOME	
201	Star Nursing Home & Pathology Clinic	Kalatala More, P.O. & P.S.: Amta, Howrah - 711401	5	PVT	N.HOME	
202	Suraksha Maternity Home	Bazarpara, Uluberia, Howrah	5	PVT	N.HOME	
203	Uluberia Nursing Home	Uluberia, Howrah	5	PVT	N.HOME	
204	Disha Eye Care	Andul Railway Sliding, Jhorehat, Howrah	4	PVT	N.HOME	EYE
205	Ma Sarada Eye Care	Goberia Govt. Colony, D. S. Lane, How - 09	4	PVT	N.HOME	EYE
206	Paul Eye Care	4/2/1, Chowdhury Para Lane, Howrah	4	PVT	N.HOME	EYE
207	Apex Club of Bally,	93, G.T. Road, P.O. Bally, Howrah	4	PVT	N.HOME	
208	Arogya Nursing Home, (Dr. P. Som)	205, Mahendra Bhattacharya Lane, Howrah	4	PVT	N.HOME	
209	Bengal Nursing Home	167/1/1, Naskarpara Lane, Ghusuri, Howrah	4	PVT	N.HOME	
210	Chokher Aloy	1/10, Bholanath Nandy Lane, Howrah	4	PVT	N.HOME	
211	Dey's Clinic	Belpukur Ajodhya, P.S.: Shyampur, Howrah	4	PVT	N.HOME	
212	East West Nursing Home	58, Bellilius Road, Howrah – 711 101	4	PVT	N.HOME	
213	Ma Sitala Nursing Home	Narikelabar, P.O. & P.S. Shyampur, Howrah	4	PVT	N.HOME	
214	Ma Tara Nursing Home	Vill. & P.O. Gobindapur, P.S.: Shyampur, Howrah	4	PVT	N.HOME	
215	Sarada Nursing Home	Bazarpara, Uluberia, Howrah	4	PVT	N.HOME	
216	Shree Maternity & Nursing Home	249, G.T. Road, Liluah, Bally, Howrah	4	PVT	N.HOME	
217	Spandan Nursing Home	46, Loaknath Chatterjee Lane, Shibpur, Howrah	4	PVT	N.HOME	
218	Sree Maternity Nursing Home	249H, G. T. Road, Liluah, Howrah	4	PVT	N.HOME	
219	Dristi Eye Foundation	5/7, Halder Para Lane, Howrah - 1	3	PVT	N.HOME	EYE
220	Microsurgical Eye Clinic & Nursing Home	1/4/2, Watking Lane, Howrah	3	PVT	N.HOME	EYE
221	Swadin Eye Care & Microsurgery Centre	2, Bibi Bagan Lane, Salkia, Howrah – 711 106	3	PVT	N.HOME	EYE
222	Arogya Niketan	Vill. & P.O. Domjur, Howrah	3	PVT	N.HOME	
223	Central Howrah Nursing Home	273, Panchanantala Road, Howrah	3	PVT	N.HOME	

DISTRICT WISE LIST OF BEDDED HCUs IN WEST BENGAL

INVENTORY: ANNEXURE - I

Sl. No	Name of the Units.	Address	Current Bed	Organisation	Category General	Category Special
224	Health Bank Nursing Home	Bagnan, Howrah	3	PVT	N.HOME	
225	Nirmala Arogya Niketan	Vill. & P.O. Nabaghara (Amta Rd. Jn.) Howrah – 711 322	3	PVT	N.HOME	
226	The Popular Clinic	72, Baje Shibpur Road, Shibpur, Howrah	3	PVT	N.HOME	
227	Bikshan Clinic & Day Caare Center	28/5, Nabanari Tala Lane, Bakshara, Howrah	2	PVT	N.HOME	
228	Sarada Eye Care	Goaberia, Danesh Sekh Lane, Howrah	2	PVT	N.HOME	
229	Green View Day Care Eye Micro Surgery Centre	Udaynarayanpur, Howrah	1	PVT	N.HOME	
230	Kumirmora Paramananda Mission Seva Niketan	Kumirmora, P.O.: Jonka, Howrah - 711 226	1	PVT	N.HOME	
231	Ruby Baby Clinic	108/3, Rabindra Sarani, Liluah, Howrah	1	PVT	N.HOME	
		TOTAL NUMBER OF BEDS IN HOWRAH DISTRICT:	4964			
JALPAIGURI						
1	Sadar Hospital – Jalpaiguri	P.O. & Dist. Jalpaiguri, Pin - 735101	610	GOVT	DH	
2	S.D. Hospital – Alipurduar	P.O. Alipurduar, Dist. Jalpaiguri, PIN - 736 121	225	GOVT	SD	
3	S.D. Hospital – MAL	P.O. Mal, Dist. Jalpaiguri - 735221	100	GOVT	SD	
4	Birpara State General Hospital	P.O. & P.S. Birpara, Dist. Jalpaiguri, PIN. 735204	100	GOVT	SG	
5	Maynaguri Rural Hospital	Vill. Hospital Para, P.O. & P.S. Maynaguri, Dist. Jalpaiguri	60	GOVT	RH	
6	Dhupguri Rural Hospital	PO.Dhupguri, Dist. Jalpaiguri.	30	GOVT	RH	
7	Falakata Rural Hospital	PO.Falakata, Jalpaiguri -	30	GOVT	RH	
8	Rajganj Rural Hospital	PO. Payachari, Dist. Jalpaiguri, PIN -735135	25	GOVT	RH	
9	Bhatibari Rural Hospital	Alipurduar – II, Bhatibari, Jalpaiguri -	20	GOVT	RH	
10	Belacoba – BPHC	Prasannagar, Jalpaiguri	15	GOVT	BPHC	
11	Jasodanga BPHC	Alipurduar – II, Jasodanga, Jalpaiguri -	15	GOVT	BPHC	
12	Kamakhyaguri BPHC	Kamargram, Kamakshyaguri, Jalpaiguri	15	GOVT	BPHC	
13	Madarihat BPHC	Madarihat, Jalpaiguri -	15	GOVT	BPHC	
14	Mongalbari BPHC	Chalsa, P.S.: Matiali, Jalpaiguri	15	GOVT	BPHC	
15	Sulkapara BPHC	Nagarkata, Sulkapara, Jalpaiguri -	15	GOVT	BPHC	
16	Uttarlatabari BPHC	Kalchini, Jalpaiguri -	15	GOVT	BPHC	
17	Panchkalguri BPHC	Alipurduar – I, Panchkalguri, Jalpaiguri -	10	GOVT	BPHC	
18	Kalinagar PHC	Kalinagar, Rajganj, Jalpaiguri -	10	GOVT	PHC	
19	Samuktola PHC	Alipurduar – II, Samuktola, Jalpaiguri –	10	GOVT	PHC	
20	Banerhat PHC	Alipurduar – II, Banerhat, Jalpaiguri -	6	GOVT	PHC	
21	Barabisa PHC	Kumargram, Barabisa, Jalpaiguri -	6	GOVT	PHC	
22	Dakshin Hanskhali PHC	Mal, Dakshin Hanskhali, Jalpaiguri -	6	GOVT	PHC	

DISTRICT WISE LIST OF BEDDED HCUs IN WEST BENGAL

INVENTORY: ANNEXURE - I

Sl. No	Name of the Units.	Address	Current Bed	Organisation	Category General	Category Special
23	Dhumpara PHC	Nagarkata, Nathna, Jalpaiguri -	6	GOVT	PHC	
24	Duramari (Salbari) PHC	Duramari, Dhupguri, Jalpaiguri -	6	GOVT	PHC	
25	Indong (Metali) PHC	Metali, Jalpaiguri -	6	GOVT	PHC	
26	Jateswar PHC	Falakata, Jateswar, Jalpaiguri -	6	GOVT	PHC	
27	Kharija Berubari PHC	Kharia Berubari, Jalpaiguri -	6	GOVT	PHC	
28	Kukrajan (Sukbari) PHC	Kukrajan, Rajganj, Jalpaiguri -	6	GOVT	PHC	
29	Kumargram PHC	Kumargram, Jalpaiguri -	6	GOVT	PHC	
30	Lataguri PHC	Mal, Lataguri, Jalpaiguri -	6	GOVT	PHC	
31	Odlabari PHC	Mal, Panbari, Jalpaiguri -	6	GOVT	PHC	
32	Ramsi PHC	Mainaguri, Panbari, Jalpaiguri -	6	GOVT	PHC	
33	Sikarpur PHC	Sikarpur, Rajganj, Jalpaiguri -	6	GOVT	PHC	
34	Singhimari (Domohani) PHC	Singhimari, Mainaguri, Jalpaiguri -	6	GOVT	PHC	
35	Sishujhuara (Sishubarihat) PHC	Madarihat, Sishubarihat, Jalpaiguri -	6	GOVT	PHC	
36	Totopara PHC	Madarihat, Totopara, Jalpaiguri -	6	GOVT	PHC	
37	Bahadur PHC	Bahadur, Jalpaiguri -	4	GOVT	PHC	
38	Barnes PHC	Mainaguri, Barnes, Jalpaiguri -	4	GOVT	PHC	
39	Bharangabari PHC	Bakali, Mainaguri, Jalpaiguri -	4	GOVT	PHC	
40	Choto Salkumar PHC	Ralakata, Choto Salkumar, Jalpaiguri -	4	GOVT	PHC	
41	Churabhandar PHC	Churabhandar, Mainaguri, Jalpaiguri -	4	GOVT	PHC	
42	Jhar Alfargram PHC	Dankanmari, Dhupguri, Jalpaiguri -	4	GOVT	PHC	
43	Lookshan PHC	Nagarkata, Lookshan, Jalpaiguri -	4	GOVT	PHC	
44	Madhyarngali Bazar PHC	Madarihat, Gopal Bagan, Jalpaiguri -	4	GOVT	PHC	
45	Mathachukla PHC	Mathachukla, Metali, Jalpaiguri -	4	GOVT	PHC	
46	Munshipara PHC	Alipurduar – I, Salkumarhat, Jalpaiguri -	4	GOVT	PHC	
47	Nadanpur Bolamari PHC	Bolamari, Jalpaiguri -	4	GOVT	PHC	
48	Rangdhamali PHC	Rangdhamali, Jalpaiguri -	4	GOVT	PHC	
49	Saptibari PHC	Saptibari, Mainaguri, Jalpaiguri -	4	GOVT	PHC	
50	Satali PHC	Kalchini, Satali Mondalpur, Jalpaiguri -	4	GOVT	PHC	
51	Shakarjhora PHC	Sajnapara, Dhupguri, Jalpaiguri -	4	GOVT	PHC	
52	Silbarihat PHC	Alipurduar – I, Silbarihat, Jalpaiguri -	4	GOVT	PHC	
53	South Berubari PHC	Manikganj, Jalpaiguri	4	GOVT	PHC	
54	Turturi PHC	Alipurduar – II, Turturi, Jalpaiguri -	4	GOVT	PHC	

DISTRICT WISE LIST OF BEDDED HCUs IN WEST BENGAL

INVENTORY: ANNEXURE - I

Sl. No	Name of the Units.	Address	Current Bed	Organisation	Category General	Category Special
55	Uttar Saripukhbari PHC	Mal, Krantihat, Jalpaiguri -	4	GOVT	PHC	
56	Rani – Ashrumati Memorial T.B. Hospital	Jalpaiguri (M), Jalpaiguri -	60	GOVT	TB	TB
57	Jalpaiguri Jail Hospital	Jalpaiguri (M), Jalpaiguri -	30	GOVT	SGJ	
58	Alipurduar Jail Hospital	Alipurduar (M), Alipurduar, Jalpaiguri -	9	GOVT	SGJ	
59	Jalpaiguri Police Hospital	Jalpaiguri (M), Jalpaiguri -	28	GOVT	SGP	
60	Divisional Railway Hospital (N.F. Rly)	Alipurduar Junction, Jalpaiguri	111	GOVT	RLY	
61	Domohini Rly. Hospital	Maynaguri (B), Domohini, Jalpaiguri -	2	GOVT	RLY	
62	Rajabhatkhawa Rly. Hospital	Maynaguri (B), Rajabhatkhwa, Jalpaiguri - RLY	2	GOVT	RLY	
63	Goodrik Group Hospital, (Aibhel T. Co.,)	P.O. Chalsa, P.S.: Matelli, Jalpaiguri	35	PVT	N.HOME	
64	Dr. Nayak's Nursing Home	2nd Mile, Sevak Road, Jalpaiguri	30	PVT	N.HOME	
65	Marina Medical and Research Centre	Babupara, Jalpaiguri	30	PVT	N.HOME	
66	Lions Eye Hospital	Alipurduar, Jalpaiguri	25	PVT	N.HOME	EYE
67	Bimala Health Care Institute	Darjeepara, P.O. & Dist.: Jalpaiguri	25	PVT	N.HOME	
68	Eveland Clinic Pvt. Ltd.	Hospital Road, Jalpaiguri	25	PVT	N.HOME	
69	Greenland Nursing Home Pvt. Ltd.,	Hospital Para, P.O. Alipurduar, Jalpaiguri	25	PVT	N.HOME	
70	Prayas Seba Sadan	Hospital Gate, Dhupguri, P.O. Biratiguri, Dist. Jalpaiguri	20	PVT	N.HOME	
71	Janakalyan Maternity Hospital	Jalpaiguri , Jalpaiguri -	12	PVT	N.HOME	
72	Child Care & Medical Centre	Ukilpara, Jalpaiguri	10	PVT	N.HOME	
73	Mary's Nursing Home	Chawpathi, Dutta Para, P.O. Alipurduar, Jalpaiguri	10	PVT	N.HOME	
74	St. Marry's Nursing Home	Choupathi, Alipurduar, Jalpaiguri - 736 121	10	PVT	N.HOME	
75	Vision Care	Alipurduar, Chowpathi, P.O.: Alipurduar, Jalpaiguri	5	PVT	N.HOME	
76	Teesta Primary Health Center	Rajganj, Jalpaiguri	4	PVT	N.HOME	
77	Dristidan	SJDA Composite Complex, P.O.: Denguajhar, Jalpaiguri	2	PVT	N.HOME	
78	Mathura Tea Estate Hospital	Alipurduar – II, Mathura Bagan, Jalpaiguri -	43	PVT	TEA EST.	
79	Katalguri Tea Estate Hospital	Dhupguri, Katalguri, Jalpaiguri -	36	PVT	TEA EST.	
80	Gopalpur & Monipur Tea Estate Hospital	Madarhat, Gopalbagan, Jalpaiguri -	35	PVT	TEA EST.	
81	Atiabari Tea Estate Hospital	Kalchini, Atabari – Bagan, Jalpaiguri -	31	PVT	TEA EST.	
82	Birendra Ch. Kundu Tea Estate Hospital	Nagarkata, Nagarkata, Jalpaiguri -	30	PVT	TEA EST.	
83	Kadambini Tea Estate Hospital	Falalkata, Jalpaiguri -	28	PVT	TEA EST.	
84	Mujnai Tea Estate Hospital	Madarhut, Mujnai, Jalpaiguri -	27	PVT	TEA EST.	
85	Binaguri Tea Estate Hospital	Dhupguri, Binaguri, Jalpaiguri -	26	PVT	TEA EST.	
86	Kalabari Rangati Tea Estate Hospital	Dhupguri, Banarhut, Jalpaiguri	26	PVT	TEA EST.	

DISTRICT WISE LIST OF BEDDED HCUs IN WEST BENGAL

INVENTORY: ANNEXURE - I

Sl. No	Name of the Units.	Address	Current Bed	Organisation	Category General	Category Special
87	Shikarpur & Bhandapur Tea Estate Hospital	Rajganj, Shikarpur, Jalpaiguri -	26	PVT	TEA EST.	
88	Madhu Tea Estate Hospital	Kalchini, Madubagan, Jalpaiguri -	21	PVT	TEA EST.	
89	Torsa Tea Estate Hospital	Kalchini, Dalsingpara, Jalpaiguri -	21	PVT	TEA EST.	
90	Anandapur Tea Estate Hospital	Mal, Anandapur, Jalpaiguri -	20	PVT	TEA EST.	
91	Debpara Tea Estate Hospital	Dhupguri, Banarhat, Jalpaiguri-	20	PVT	TEA EST.	
92	Indong Tea Estate Hospital	Metali, Jalpaiguri -	20	PVT	TEA EST.	
93	Nintijhora, Tea Estate Hospital	Kalchini, Jalpaiguri -	20	PVT	TEA EST.	
94	Palasbari Tea Estate Hospital	Dhupguri, Banarhat, Jalpaiguri -	20	PVT	TEA EST.	
95	Nepuchapur Tea Estate Hospital	Chalsa, Baradighi, Jalpaiguri -	19	PVT	TEA EST.	
96	Chunia Jhora Tea Estate Hospital	Kamakhyaguri, Hatipota, Jalpaiguri -	16	PVT	TEA EST.	
97	Kohinorr Tea Estate Hospital	Alipurduar – II, Kohinoor Tea Garden, Jalpauguri -	15	PVT	TEA EST.	
98	Dhowlajhora Tea Estate Hospital	Alipurduar – II, Dhowlajhora, Jalpaiguri -	14	PVT	TEA EST.	
99	Diana Tea Estate Hospital	Dhupguri, Banarhat, Jalpaiguri -	12	PVT	TEA EST.	
100	Ethelbari Tea Estate Hospital	Falakata, Birpara, Jalpaiguri -	12	PVT	TEA EST.	
101	Gurjanjhora Tea Estate Hospital	Mal, Jalpaiguri -	12	PVT	TEA EST.	
102	Bhandiguri Tea Estate Hospital	Rajganj, Prasanna Nagar, Jalpaiguri -	10	PVT	TEA EST.	
103	Dhekeapara Tea Estate Hospital	Madarihat, Birpara, Jalpaiguri -	10	PVT	TEA EST.	
104	Kailaspur Tea Estate Hospital	Mal, Rajadanga, Jalpaiguri -	8	PVT	TEA EST.	
105	Saraswatipur Tea Estate Hospital	Rajganj, Saraswati Bagan, Jalpaiguri -	8	PVT	TEA EST.	
106	Singhania Tea Estate Hospital	Madarihat, Birpara, Jalpaiguri -	8	PVT	TEA EST.	
107	Turturi Tea Estate Hospital	Kamakhyaguri, Hatipota, Jalpaiguri -	8	PVT	TEA EST.	
108	Nedam, Tea Estate Hospital	Mal, Banarhut, Jalpaiguri -	6	PVT	TEA EST.	
109	Joypur Tea Estate Hospital	Prasanna Nagar, Jalpaiguri -	5	PVT	TEA EST.	
110	Sreenathpur Tea Estate Hospital	Kamakhyaguri, Dakshin Dholkar, Jalpaiguri -	5	PVT	TEA EST.	
111	Raypur Tea Estate Hospital	Randhamali, Jalpaiguri -	4	PVT	TEA EST.	
112	Jaldhaka Atadanga Tea Estate Hospital	Dhupguri, Nathoahut, Jalpaiguri -	2	PVT	TEA EST.	
113	Karala Valley Tea Estate Hospital	Prasannagar, Jalpaiguri -	2	PVT	TEA EST.	
114	Dharanipur Tea Estate Hospital	Nagarkata, Chengmari, Jalpaiguri -	1	PVT	TEA EST.	
115	Surendra Nagar Tea Estate Hospital	Dhupguri, Jalpaiguri -	1	PVT	TEA EST.	
		TOTAL NUMBER OF BEDS IN JALPAIGURI DISTRICT:	2651			

DISTRICT WISE LIST OF BEDDED HCUs IN WEST BENGAL

INVENTORY: ANNEXURE - I

Sl. No	Name of the Units.	Address	Current Bed	Organisation	Category General	Category Special
KOLKATA						
1	Nilratan Sarkar Medical College & Hospital	138, A.J.C. Bose Road, Kol - 14	1890	GOVT	MCH	
2	Medical College & Hospital	88 College Street., Kolkata - 700 073	1718	GOVT	MCH	
3	S.S.K.M. Hospital	244, A.J.C. Bose Road, Kol - 20	1650	GOVT	MCH	
4	Calcutta National Medical College	24, Gorachand Road, Kol -14	1260	GOVT	MCH	
5	R.G. Kar Medical College & Hospital	1, Belgachia Road, Kol - 37	1107	GOVT	MCH	
6	J.B. Roy Ayurvedic Medical College and Hospital	170, 172, Raja Dinendra Street, Kol - 5	120	GOVT	MCH	
7	M.R. Bangur Hospital	241, Deshpran Sheshmal Road, Kolkata - 33	600	GOVT	DH	
8	Vidyasagar State General Hospital	Brahma Samaj Rd.,(D.H. Rd), Kol - 34	256	GOVT	SG	
9	Bagha Jatin State General Hospital	Military Road, PO. Regent Estate, P.S. Jadavpur, Bagha Jatin, Kol - 92	100	GOVT	SG	
10	S.N. Pandit Hospital	11, Elgin Road, Kol - 20	576	GOVT	SGH	
11	Chittaranjan Seva Sadan,	37, S.P. Mukherjee Road, Kol - 26	324	GOVT	SGH	
12	Lady Duffrin Hospital	Amherst Street, Kol - 9	274	GOVT	SGH	
13	Calcutta Pavlov Hospital	18, Gobra Road, Kol - 46	250	GOVT	SGH	
14	Dr. B.C. Roy Memorial Hospital for Children	11, Narkeldanga Main Road, Kol - 54	250	GOVT	SGH	
15	B.C. Roy Polio Clinic & Hospital	38, Badan Roy Lane, (C.I.T. Road), Scheme IV (M), Kol - 10	200	GOVT	SGH	
16	School of Tropical Medicine	Chittaranjan Avenue, Kol - 73	150	GOVT	SGH	
17	North Suburban Hospital	82, Cossipore Road, Kol - 2	137	GOVT	SGH	
18	Ramrikdas Haralalka Hospital	104, Ashutosh Mukherjee Road, Kol - 25	130	GOVT	SGH	
19	Bangur Institute of Neuroscience & Psychiatry	52/1A, S.N. Pandit Street, Kol - 25	106	GOVT	SGH	
20	Abinash Dutta Maternity Hospital	109, B.K. Pal Avenue, Kol - 5	100	GOVT	SGH	MNTY
21	Institute of P. G. Aurvedic Education & Research.	294/ 3/1, A. P. C. Road, Kol-9	75	GOVT	SGH	
22	Calcutta Homeopathic Medical College & Hospital	265 & 266, A.P.C. Road, Kol - 6	50	GOVT	SGH	
23	Institute of Psychiatry	7, D.L. Khan Road, Kol - 25	36	GOVT	SGH	
24	D.N. Dey Homeopathic Hospital	15/1, Gobinda Khotick Road, Kol - 46	30	GOVT	SGH	
25	Indira Matri O Sishu Kalyan Hospital	36, Raja Manindra Road, Kol-37	30	GOVT	SGH	MNTY
26	Vijaygarh State General Hospital	Vijaygarh, Kol - 32	30	GOVT	SGH	
27	Viswanath Ayurvedic Mahavidyalaya & Hospital	94, Gray Street, Kol - 5	20	GOVT	SGH	
28	I.D. & B. G. Hospital	Beliaghata Main Road, Kol - 10	780	GOVT	ID	ID
29	Dr. R. Ahmed Dental College & Hospital	114, A.J.C. Bose Road, Kol - 14	100	GOVT	Dental	DENT
30	K.S.Roy T.B. Hospital	Jadavpur, Kolkata - 700 032	350	GOVT	TB	TB
31	Lumbini Park Mental Hospital	115, Dr. Giridhari Sekhar Bose Road, Kol - 39	190	GOVT	MNH	MNTL

DISTRICT WISE LIST OF BEDDED HCUs IN WEST BENGAL

INVENTORY: ANNEXURE - I

Sl. No	Name of the Units.	Address	Current Bed	Organisation	Category General	Category Special
32	Alipur Central Correctional Home	Alipore, Kol - 27	50	GOVT	SGJ	
33	Alipur Special Correctional Home (Mental Hospital)	1, Reformatory street, Alipore, Kol - 27	50	GOVT	SGJ	
34	Presidency Jail Hospital	3 Thakrey Road, Alipur, Kol - 27	50	GOVT	SGJ	
35	E.S.I. Hospital (Manicktala)	V.I.P. Road, Kol - 54	422	GOVT	SGL	
36	E.S.I. Hospital (Sealdah)	301/3, A.P.C. Road, Kol - 9	182	GOVT	SGL	
37	Calcutta Police Hospital	2, Beninandan Street, Kol - 25	300	GOVT	SGP	
38	New Vagrant's Home	153, Sarat Bose Road, Dhakuria, Kol - 78	33	GOVT	SGV	
39	Leprosy Vagrant's Home	75/1, Beliaghata Main Road, Kol - 10	13	GOVT	SGV	
40	Institute of Animal Health & Veterinary Biologicals	87, Belgachia Road, kol - 37	Veterinary	GOVT	SGVH	
41	Chittaranjan National Cancer Institute	37, S.P. Mukherjee Road, Kol - 26	200	GOVT	CG	CAN
42	Regional Institute of Unani Medicine	79B, C.R. Avenue, Kol - 73	25	GOVT	CG	
43	Gun & Shell Factory Hospital	Cossipore, Kolkata-700002	76	GOVT	DEF	
44	Centenary Hospital	Kolkata Port Trust, 1, Diamond Harbour Road, P.O. New Alipore, Kol - 53	104	GOVT	PORT	
45	B.R.Singh. Hospital (Rly)	Sealdah, Kol - 14	461	GOVT	RLY	
46	S. E. Railway Central Hospital	S.E. Rly. Garden Reach, Kol - 43	303	GOVT	RLY	
47	Metro Railway Hospital	120, Deshpran Sasmal Road, Kolkata - 700 033.	30	GOVT	RLY	
48	Khidirpore Maternity Home,	34, Ekbalpore Road, Kol - 23	40	GOVT	KMC	MNTY
49	Champa Moni Maternity Home	59, Cristopher Road, Kol - 46	20	GOVT	KMC	MNTY
50	Garden Reach Maternity Home	2B, Prince Dilwarjab Lane, Garden Reach, Kol-24	20	GOVT	KMC	MNTY
51	North Maternity Home	22, Nilmani Mitra Road, Kol - 6	20	GOVT	KMC	MNTY
52	M.T.M. T.B. Hospital [Boral TB Hosp]	Boral Main Road, Kol - 84	150	GOVT	MUNI	TB
53	Ramkrishna Mission Seva Pratisthan	99 Sarat Bose Road, Kol - 26	550	PVT	N.HOME	
54	Kothari Medical Centre	8B, Alipore Road, Kol - 27	340	PVT	N.HOME	
55	The Calcutta Medical Research Institute	7/2, Diamond Harbour Road, Kol - 27	338	PVT	N.HOME	
56	Eastern India Health Care Foundation	324, Barakhola, P.S.: Purba Jadavpur, P.O.: Mukundapur, Kol - 700 099.	325	PVT	N.HOME	
57	Rabindranath Tagore International Institute of Cardiac Sciences	124, Mukundapur, E.M. Bypass, Kol - 99	325	PVT	N.HOME	
58	KPC Medical College & Hospital	1F, Raja S. C. Mullick Road, Jadavpur, Kolkata - 32	320	PVT	N.HOME	
59	Apollo Gleneagles Hospital Ltd.	58, Canal Circular Road, Kol - 54	300	PVT	N.HOME	
60	Peerless Hospital & Research Centre	360., Panchasayar, Kol - 94	300	PVT	N.HOME	
61	Cancer Centre & Welfare Home & Research Cent	M.G.Road, Thakurpukur, Kol - 63	260	PVT	N.HOME	CAN
62	Marwari Relief Society Hospital	227, Rabindra Sarani, Kol - 7	239	PVT	N.HOME	
63	Woodland Medical Centre Ltd.	8/5, Alipore Road, Kol - 27	230	PVT	N.HOME	

DISTRICT WISE LIST OF BEDDED HCUs IN WEST BENGAL

INVENTORY: ANNEXURE - I

Sl. No	Name of the Units.	Address	Current Bed	Organisation	Category General	Category Special
64	Islamia Hospital	73, C.R. Avenue, Kol - 12	200	PVT	N.HOME	
65	Vision Care Research & Education Foundation	230, Barakhola, Purba Jadavpur, Kolkata - 700 099.	200	PVT	N.HOME	
66	P. N. Memorial Neurocentre & Research Institute Ltd.	720, Anandapur, E. M. Bypass, Kolkata- 107	200	PVT	N.HOME	
67	Advance Medicare & Research Institute	P-4 & 5, C.I.T. Sch, Block-A, 15, Panchanantala Road Kol -29	190	PVT	N.HOME	
68	Advance Medicare & Research Institute	15, Panchanantala Road, Kolkata - 700 029.	190	PVT	N.HOME	
69	A.G.Hospital & Research Centre (Mission of Mercey Hopital)	125/1 Park Street, Kol - 17	173	PVT	N.HOME	
70	B. M. Birla Heart Research Centre	1/1, National Library Avenue, Kol - 27	160	PVT	N.HOME	
71	Behala Balananda Brahmachary Hospital	151 & 153 D. H. Road, Kol -34	158	PVT	N.HOME	
72	Sri Bishudananda Hospital & Research Inst.	35/37, Bartala Street, Kol - 7	152	PVT	N.HOME	
73	Iris Health Services Limited	82/1, Raja S.C. Mullick Road, PO. Naktana, PS. Jadavpur, Kol -700047	150	PVT	N.HOME	
74	Ruby General Hospital	E.M. Bye-Pass Golpark, Kasba, Kol - 78	150	PVT	N.HOME	
75	Jitendra Narayan Ray Sishu Seva Bhawan & General Hosp	58/1S, Raja Debendra Street, Kol - 6	141	PVT	N.HOME	
76	S.V.S. Marwari Hospital	118, Raja Ram Mohan Sarani, P.S.: Amherst St., Kol - 9	140	PVT	N.HOME	
77	B. P. Podder Hospital & Medical Res. Institute	71/1, Humayun Kabir Sarani, Bl.-G, New Alipore, Kol - 53	137	PVT	N.HOME	
78	G. D. Diabetes Institute and Speciality Clinics (P) Ltd.	139A, Lenin Sarani, Dharmatala, Muchipara, Kolkata - 700 013.	120	PVT	N.HOME	
79	Park Clinic	4, Gorkey Terrace, Kol - 17	115	PVT	N.HOME	
80	Belle Vue Clinic	9, Loudon Street, Kol - 17 (9, Dr. U.N. Bramhachari Street, Kol - 700 017)	110	PVT	N.HOME	
81	Health Point (A Multi-Speciality Hospital)	21 & 21/1 Prannath Pandit Street, Kolkata - 700 025.	100	PVT	N.HOME	
82	Lohia Matri Seva Sadan	296B, Rabindra Sarani, Kol - 6	100	PVT	N.HOME	
83	Nightangle Diagnostic & Medicare Centre (P) Ltd.	11, Shakespear Sarani, Kol - 71	100	PVT	N.HOME	
84	Ramkrishna Sarada Mission Matri Bhavan	7A, Sree Mohan Lane, P.O.: Kalighat, Kol – 26	100	PVT	N.HOME	
85	Sri Arabinda Seva Kendra	1H, Gariahat Road (S), Kol - 68	100	PVT	N.HOME	
86	Institute of Child Health (Children Hospital)	11, Dr. Biresh Guha Street, Kol – 17	85	PVT	N.HOME	
87	Bhagirathi Neotia W&CC Centre (Park Hospital)	2 Sarojini Naidu Sarani, Kol - 17 (2, Rawdon Street, Kolkata-700 017)	83	PVT	N.HOME	
88	Matri Mangal Pratisthan	228, Rabindra Sarani, Kol - 7	75	PVT	N.HOME	
89	Ekbalpore Nursing Home	9, Ibrahim Road, PO. & PS. Ekbalpur, Kolkata - 23	71	PVT	N.HOME	
90	Premanand Memorial Leprosy Hospital	259-A, A.P.C. Road, Kol - 6	70	PVT	N.HOME	LEPR
91	Apex Institute of Medical Sciences	1219, Survey Park, Kolkata - 75	65	PVT	N.HOME	
92	Rahamat Bhai Vadnagarwala Mat & N.Home	36, Ganesh Ch. Avenue, Kol - 13	65	PVT	N.HOME	
93	Student's Health Home	142/2, A. J.C. Bose Road, Kol - 14	65	PVT	N.HOME	
94	Repose Cl. & Res. Cen. (P) Ltd. Nursing Home	20/B & 20/C, Broad Street, Kol - 19	62	PVT	N.HOME	
95	Divine Nursing Home Pvt. Ltd.	11/A, Abinash Ch. Banerjee Lane, Kol - 10	60	PVT	N.HOME	

DISTRICT WISE LIST OF BEDDED HCUs IN WEST BENGAL

INVENTORY: ANNEXURE - I

Sl. No	Name of the Units.	Address	Current Bed	Organisation	Category General	Category Special
96	Dreamland Nursing Home	2, Naya Ratna Lane, P.O. & P.S. Shymbazar, Kol – 700 004	60	PVT	N.HOME	
97	Royd Nursing Home	5 - B Royd Street, Kol -16	60	PVT	N.HOME	
98	Belle Vue Clinic	10, Loudon Street, Kol - 17(10, Dr. U.N. Bramhachari Street, Kol - 700 017)	58	PVT	N.HOME	
99	The Sherwood Nursing Home	30D, College Street, Kolkata - 12	58	PVT	N.HOME	
100	Labbaik Medical Center (P) Ltd.	40, Kavi Mohammad Eqbal Road, Kolkata - 700 023.	56	PVT	N.HOME	
101	Bangur Medicare Research Inst. Pvt. Ltd.	8A, D. H. Road, Kol-63	52	PVT	N.HOME	
102	North City Hospital & Neuro Inst. (p) Ltd	73, Bagmari Rd. Kol - 54	52	PVT	N.HOME	
103	Matiaburuz Seva Sadan	Y-282/A, Khaldhari Road, Kol - 18	50	PVT	N.HOME	
104	May Flower Nursing Home	114/A, 893, Rippon Street, Kol - 17	50	PVT	N.HOME	
105	R. S. V. Nursing Home & Speciality Diagnostic Center	40, Deshapran Sasmal Road, Tollygunge Phari, P.S.: Regent Park, Kol - 33	50	PVT	N.HOME	
106	Sanjibani N. Home (Formerly Devout N. Home)	113 James Long Sarani PO-Thakurpukur Kol-63	50	PVT	N.HOME	
107	South Calcutta Clinic	19, Hindusthan Road, Kol - 26	50	PVT	N.HOME	
108	The Institute of Neurosciences	185A, A.J.C. Bose Road, Kolkata - 17	50	PVT	N.HOME	
109	Lansdown Nursing Home	119, Sarat Bose Road, Kol – 26	48	PVT	N.HOME	
110	Saviour Clinic and Nursing Home Pvt Ltd.	2.Dr. Suresh Sarkar Road,Kol-14	48	PVT	N.HOME	
111	Thelasemia Management & day care center	58, Nimalaghat Street, Kol - 06	48	PVT	N.HOME	
112	Vivekananda Seba Samity & Hospital	P-516/1, Banamali Naskar Road, Kol - 60	48	PVT	N.HOME	
113	Primvada Birla Aravind Eye Hospital	10, Loudon Street, Kol - 17	46	PVT	N.HOME	EYE
114	Charring Cross Nursing Home	2C, Motilal Basak Lane, Kol - 54	46	PVT	N.HOME	
115	Health & Care Hospital	1/2, Dr. Dhiren Sen Sarani, Kolkata - 700 006	45	PVT	N.HOME	
116	Life Line Diag Cent & Nursing Home	4/A, Wood Street, Kol - 16	45	PVT	N.HOME	
117	Capitol Nursing Home	288/2, A.P.C. Road, Kol - 9	40	PVT	N.HOME	
118	Family Planning asso. Of India	28 C, Shakespear Sarani Kol - 17	40	PVT	N.HOME	
119	Gama Century Health care Pvt. Ltd.	3/B, Albert Road, Kol - 17	40	PVT	N.HOME	
120	J & P Hemani Memorial Hospital	20 Pollock Street, Kolkata - 700 001.	40	PVT	N.HOME	
121	Paramount Nursing Home	109/1, Hazra Road, Kol - 26	40	PVT	N.HOME	
122	The Gujrati Relief Society	20, Pollock Street, Kol - 7	40	PVT	N.HOME	
123	Dilkhusa N. Home & Medical Res. Cent	94A, Dilkhusa Street, Kol - 17	36	PVT	N.HOME	
124	TRA General Hospital	7, Dr. Biresh Guha Street, Kol - 17	36	PVT	N.HOME	
125	Beckbagan Nursing Home	1/1, Ahiri Pukur 1st Lane, Kol - 19	35	PVT	N.HOME	
126	Eskag Sanjeevani	P-48, Kshirode Bidya Binod Avenue, Kol - 3	35	PVT	N.HOME	
127	Guru Teg Bahadu Medical Service & Res.	11, Debendra Lal Khan Road, Kol - 27	35	PVT	N.HOME	

DISTRICT WISE LIST OF BEDDED HCUs IN WEST BENGAL

INVENTORY: ANNEXURE - I

Sl. No	Name of the Units.	Address	Current Bed	Organisation	Category General	Category Special
128	Irimed Clinic	P-48, Kshirode Bidya Binod Avenue, Kol - 3	35	PVT	N.HOME	
129	M. B. Nursing Home Pvt. Ltd.	55 - B, Dilkhusa Street, Kol - 17	35	PVT	N.HOME	
130	Rameswara Nursing Home	P-155, C.I.T. Scheme VII (M), Kol - 54	35	PVT	N.HOME	
131	Wockhart Hospital Kilney Institute	111B, Rashbehari Avenue, Kol - 29	35	PVT	N.HOME	
132	Port View Nursing Home & Diag.Res.Cen.P.L.	7, Dr. Sudhir Bose Road, Kol - 23	32	PVT	N.HOME	
133	Ashram Bhimaniwala Hospital	55, K.K. Tagore Street, Kol - 7	30	PVT	N.HOME	
134	Baul Mon Nursing Home	34, Cental Road, Kol - 32	30	PVT	N.HOME	
135	Care Centre Nursing Home,	377/3, P. A. Shah Road, Kolkata - 68	30	PVT	N.HOME	
136	Cure Centre Nursing Home	377/3, P.A. Shah Road, Kol - 68	30	PVT	N.HOME	
137	East India Health Care (P) Ltd.	1470, Rajdanga Main Road, Kol- 107	30	PVT	N.HOME	
138	Jeevan Suraksha Clinic & Nursing Home (P) Ltd.	1/2, Dr. Dhiren Sen Sarani, Kolkata - 700 006	30	PVT	N.HOME	
139	Mediview Nursing Home (P) Ltd.	74, Broad Street, Kol - 19	30	PVT	N.HOME	
140	Mohan Clinic	46, Lake Temple Road, Kol- 29	30	PVT	N.HOME	
141	South Suburban Clinic (P) Ltd.	67, D.H. Road, Kol - 38, South 24 Pgs.	30	PVT	N.HOME	
142	Sree Lakshmi Narayan Trust & Maternity Home	4, Justice Chandra Madhab Road, Kol - 26	30	PVT	N.HOME	MNTY
143	Strling Hospital	55/1, B. B. Avenue, Kol - 30	30	PVT	N.HOME	
144	Swadesh Basu Hospital	204/A, D. H. Rd,Thakurpukur Kol - 63	30	PVT	N.HOME	
145	The May Fair Howpital (P) Ltd.	34/1A, B.T. Road, Kol - 2	30	PVT	N.HOME	
146	Metropolitan Laboratory & Nursing Home	18, Shakespeare Sarani, Kolkata - 700 071.	29	PVT	N.HOME	
147	N. G. Nursing Home	23, Southern Avenue, Kolkata - 26	29	PVT	N.HOME	
148	Park Point Nursing Home	16A, Park Lane, Kol -16	29	PVT	N.HOME	
149	Merry Land Nursing Home	P-46, C.I.T. Road, Kol - 14	28	PVT	N.HOME	
150	Rippon Nursing Home	52, Repon Street, Kol - 16	26	PVT	N.HOME	
151	United Nursing Home,	107/1, Narkeldanga Main Road, Kol - 54	26	PVT	N.HOME	
152	Netaji Eye Hospital	4/3K/101 Satellite Township, Sakuntala Park, Kolkata - 700 061	25	PVT	N.HOME	EYE
153	Arunima Hospice	81, D. H. Road, Barisha, Oxford Mission, Kolkata - 700 008.	25	PVT	N.HOME	
154	Basanti Devi Nursing Home	Garia Station Road (Oppsite B. P. High School), Kol - 84	25	PVT	N.HOME	
155	Bellona Nursing Home	52A D.H. Road, Kol - 23	25	PVT	N.HOME	
156	Kalidas Mullick Sebayatan	47, Ganesh Ch. Avn, Kolkata - 13	25	PVT	N.HOME	
157	New Saraju Nursing Home	46/1C, B.T. Road, Kol - 2	25	PVT	N.HOME	
158	Remedy	91/A, Lalmohan Bhatteejee Road, Kol-14	25	PVT	N.HOME	
159	Sree Sree Mohananda Brahmachari (N.H.)	172, A.J.C. Bose Road, Kol - 14	25	PVT	N.HOME	

DISTRICT WISE LIST OF BEDDED HCUs IN WEST BENGAL

INVENTORY: ANNEXURE - I

Sl. No	Name of the Units.	Address	Current Bed	Organisation	Category General	Category Special
160	St. Marry Nursing Home	2/1. Ho-Chi-Minh Sarani, Kol -71	25	PVT	N.HOME	
161	Eveland Nursing Home	6, Southern Avenue, Kol - 26	24	PVT	N.HOME	
162	New Life (Nursing Home)	24/A, N.B. Lane, Kol - 26	24	PVT	N.HOME	
163	B. N. Basu Memorial Clinic	34B, Jatin Das Road, Kol - 29	23	PVT	N.HOME	
164	Presidency Medical Center	55, Leela Roy Sarani, Kolkata - 700 019	22	PVT	N.HOME	
165	Sun Flower Nursing Home	1/1, Goa Bagan Street, Kol - 6	21	PVT	N.HOME	
166	Calcutta Lions Netra Niketan	18/2, A/2 Uday Shankar Sarani, Golf Green Scheme, Kol - 95	20	PVT	N.HOME	EYE
167	Calcutta Gujrati Hospital	8, Radha Bazar Lane, Kolkata - 700 001	20	PVT	N.HOME	
168	Calcutta Medical Complex	21, Molana Abul Kalam Azad Sarani, Kol - 11	20	PVT	N.HOME	
169	Calcutta Pay Clinic & Hospital.	215, Park Street, Kol- 17	20	PVT	N.HOME	
170	City Rand Medical Service	294, M. G. Road, Kol - 82	20	PVT	N.HOME	
171	Cosmos Hospital	155, Purabdiganta, Kolkata - 700 075.	20	PVT	N.HOME	
172	Don View Nursing Home	4L, Tiljala Road, Kol - 46	20	PVT	N.HOME	
173	Dr. M.N. Chatterjee Memorial Eye Hospital	295/1, A.P.C. Road, Kol - 9	20	PVT	N.HOME	
174	Garden Reach Nursing Home	B-27, Iron Gate Road, Kol - 18	20	PVT	N.HOME	
175	Giridharilal Hansraj Kamani Hospital	8, Radha Bazar Lane, Kol - 1	20	PVT	N.HOME	
176	Good Samritan Hospital	6, Dr. Biresh Guha St., Kol- 17	20	PVT	N.HOME	
177	Grand View Nursing Home	2, Ramani Chatterjee Road, Kol - 2	20	PVT	N.HOME	
178	Harrington Nursing Home & Diagnostic Center	6, Ho Chi Minn Sarani, Kolkata - 700 071	20	PVT	N.HOME	
179	Islamia Medical Institute	1, New Park Road, Kol - 7	20	PVT	N.HOME	
180	Lions Orthopedic Hospital	141, Regent Park, Kol - 40	20	PVT	N.HOME	
181	M.P. Birla Eye Clinic	12, Dr. U. N. Bramhachari Rd., Kol - 17	20	PVT	N.HOME	
182	Micro Lap. C/o. D.K., Mukherjee ,	24, B.P. Road, Kol - 26	20	PVT	N.HOME	
183	Mohananda Bramhachari Sishu Sadan	57A, Roy Bahadur Road, Kol - 34	20	PVT	N.HOME	
184	Netaji Nursing Home	4D, Ekbalpore Lane, Kol - 23	20	PVT	N.HOME	
185	Paharpur Nursing Home	H-68, Paharpur Road, Kol - 24	20	PVT	N.HOME	
186	Ramkrishna Medical Complex	132/2/12, Narkeldanga Main Road, Kol - 54	20	PVT	N.HOME	
187	Rit-Tik Nursing Home & Research Centre	155A, A.J.C. Bose Road, Kol - 14	20	PVT	N.HOME	
188	Sandipani Nursing Home	8/L, Yogodyan Lane, Kol - 54	20	PVT	N.HOME	
189	Shusrusha Nursing Home	P-290, C.I.T. Scheme VI (M), Kol - 54	20	PVT	N.HOME	
190	The Bengal Nursing Home	8A, Beadon Street, Kol - 6	20	PVT	N.HOME	
191	The Orthopedic & Fracture Clinic	15/2, Sarat Bose Road, Kol- 20	20	PVT	N.HOME	

DISTRICT WISE LIST OF BEDDED HCUs IN WEST BENGAL

INVENTORY: ANNEXURE - I

Sl. No	Name of the Units.	Address	Current Bed	Organisation	Category General	Category Special
192	Usti Foundation	5 Nehru Colony, Kol- 48	20	PVT	N.HOME	
193	Samaritan Clinic (P) Ltd.	10/4D, Lala Lajpat Rai Sarani, Kolkata - 20	19	PVT	N.HOME	
194	Arogya Maternity & Nursing Home	71, Tollygunj Circular Road, Kol- 53	18	PVT	N.HOME	
195	Asha Nursing Home	18B, Bedford Lane, Kol – 16,	18	PVT	N.HOME	
196	Astha Medical Services Pvt. Ltd.	48/2 Q, B. T. Road, Kol- 50	18	PVT	N.HOME	
197	Orchid Nursing Home	P-17, C.I.T. Scheme VI (M), Kol – 54	18	PVT	N.HOME	
198	Remicure Nursing Home (Prop. Sm. A.Dey)	100A, C.I.T. Road, Kol – 14	18	PVT	N.HOME	
199	Super Health care Centre (P) Ltd.	200, Rajdanga Nabapally, Kol- 78	18	PVT	N.HOME	
200	Medi Care Co - operative society(Care Hospital)	P-14/A, C.I.T. Sch. VIII(M), Kol – 67, Ultadanga	17	PVT	N.HOME	
201	New Union Nursing Home (P) Ltd.	6, Robinson Street, Kol –17	17	PVT	N.HOME	
202	North Land Nursing Home	133, Bidhan Sarani, Kol – 6	17	PVT	N.HOME	
203	Swastik Seva Sadan	16C, Tiljala Road, Kol - 46	17	PVT	N.HOME	
204	Apex Clinic Pvt. Ltd.	844 A, Raja Ram Mohan Roy Road, Kol-8	16	PVT	N.HOME	
205	Apex Nursing Home and Research Centre	3B, Shyam Square East, Kol - 03	16	PVT	N.HOME	
206	Elite Nursing Home	11/A, Manohar Pukur Road, Kol – 26	16	PVT	N.HOME	
207	Mapel Nursing Home	17A, Biprodas Street, Kol – 9	16	PVT	N.HOME	
208	Princep Nursing Home	41, Princep Street, Kol – 72	16	PVT	N.HOME	
209	Sanjeevani Health Care Services	4A, Wood Street, Kol-16	16	PVT	N.HOME	
210	N.B.M. Eye Hospital(Vision Welfare Society)	Station Park, Gorla, Kol - 84	15	PVT	N.HOME	EYE
211	Alpha Medical Services (P) Ltd.	13, Elgin Road, Kolkata - 700 020	15	PVT	N.HOME	
212	Arogya Nursing Home	P-44, C.I.T. Scheme VII (M), Kol – 54	15	PVT	N.HOME	
213	Ashutosh Nursing Home	21/B, Sadananda Road, Kol – 26	15	PVT	N.HOME	
214	Avenue Nursing Home	3ABC Madan Street, Kolkata - 700 072.	15	PVT	N.HOME	
215	Ballygunge Maternity Nursing Home	20/1/1M , Ballygunge Station Road, Kol -19	15	PVT	N.HOME	
216	Beniapukur Nursing Home	43 Gorachand Road, Kol - 14	15	PVT	N.HOME	
217	Circular Nursing Home	27/1, Creek Row, Kol – 14	15	PVT	N.HOME	
218	Dover Medical Centre (Psychiatric)	11D, Dover Lane, Kol – 29	15	PVT	N.HOME	
219	Eye Care & Research Cent	12A, Dr. Biresh Guha Street, Kol - 17	15	PVT	N.HOME	
220	In Firmary Nursing Home	39A, Southern Avenue, Kol - 29	15	PVT	N.HOME	
221	James Long Clinic Pvt. Ltd.	33, James Long Sarani , Kol - 34	15	PVT	N.HOME	
222	Kusum Joyti Nursing Home	204, A.P.C. Road, Kol - 4	15	PVT	N.HOME	
223	L B Nursing Home	204A, APC Road, Kolkata - 700 04.	15	PVT	N.HOME	

DISTRICT WISE LIST OF BEDDED HCUs IN WEST BENGAL

INVENTORY: ANNEXURE - I

Sl. No	Name of the Units.	Address	Current Bed	Organisation	Category General	Category Special
224	Life Nursing Home	136, Santoshpur Avenue, Kol – 75	15	PVT	N.HOME	
225	Medline Nursing Home	48/30, Purna Chandra Mitra Lane, Swiss Park, Kol - 33	15	PVT	N.HOME	
226	N.G. Medicare	123A, Rash Behari Avenue, Kol - 29	15	PVT	N.HOME	
227	Netaji Subhas Chandra Bose Cancer Research Institute	16A, Park Lane, Kol –16	15	PVT	N.HOME	
228	Pratihar Nursing Home	4, Sauren Roy Road, Kol – 34	15	PVT	N.HOME	
229	Sudhir Medical (P) Ltd.	31/14A, K. P. Mukherjee Road, Behala, Kol - 08	15	PVT	N.HOME	
230	Swiss Park Nursing Home	48/4, Swiss Park, Kol – 33	15	PVT	N.HOME	
231	Udyan Nursing Home	200/1A, N.S.C. Bose Road, Kol – 47	15	PVT	N.HOME	
232	Zenith Point Nursing Home	32A, Ram Ratan Bose Lane, Kol - 3	15	PVT	N.HOME	
233	Amrapali Medical Centre & Nursing Home	5B, Dover Lane, Kol – 29	14	PVT	N.HOME	
234	Central Calcutta Nursing Home	73-A, Ganesh Ch, Avenue, Kol - 13	14	PVT	N.HOME	
235	Fine Point Nursing Home (Prof. A.Chakraborty)	227/A/B, A.P.C. Road, Kol – 4	14	PVT	N.HOME	
236	Mediview Clinic & Research Cent. Pvt. Ltd.	74 Broad St., Kol- 19	14	PVT	N.HOME	
237	North Calcutta Nursing Home	223, A.P.C. Road, Kol – 4	14	PVT	N.HOME	
238	Southern Nursing Home	66, Monoharpukur Road, Kolkata - 700 029.	14	PVT	N.HOME	
239	The Gariahat Kidney Care Centre	26/4, Hindusthan Park, Kol – 29	14	PVT	N.HOME	
240	Eastern Calcutta Medical Research Centre	171/K/1, Picnic Garden Rd, Kol-39 (VIP Market)	13	PVT	N.HOME	
241	Medi Citi Nursing Home	64A, D. H. Road, Kolkata - 700 023.	13	PVT	N.HOME	
242	Bright Nursing Home	31/A, Bright Street, Kol – 17	12	PVT	N.HOME	
243	Dew Drop Nursing Home	16, Elliot Road, Kolkata - 700 016	12	PVT	N.HOME	
244	Sunetra (Unit of CERF)	1050/1 Survey Park, Kol - 75	12	PVT	N.HOME	
245	Dristi Pradip Eye Midcro & Phaco Surgery Centre	1/341, Garaihat Road, Kol - 68	10	PVT	N.HOME	EYE
246	Sankar Netralaya	10, Raja Subodh Mullick Square, Kolkata - 700 013.	10	PVT	N.HOME	EYE
247	Silver Line Eye Hospital	396, P.A. Shah Road, Kol - 45	10	PVT	N.HOME	EYE
248	Acharya Durga Prasanna Paramhansa Sevayatan,	4D, Naktala Road, P.O.: Naktala, Jadavpur, Kolkata - 700 047	10	PVT	N.HOME	
249	Alipur Nursing Home & Medical Research	23A, Baker Road, Kol – 27	10	PVT	N.HOME	
250	Angel Meternity Nursing Home	3, Momedan Bagan Lane, Kol –16	10	PVT	N.HOME	
251	Apollo Glenagles Clinic	48/1F, Lila Roy Sarani, Kol – 19	10	PVT	N.HOME	
252	Ashirbad Nursing Home	44-B, Vivekananda Road, Kol – 6	10	PVT	N.HOME	
253	Ayub Ansari Nursing Home,	Q-39, SA Farooque Road, P.O.: Garden Reach, Kolkata - 700 024	10	PVT	N.HOME	
254	B. P. Poddar Clinic	Poddar Court, 4 No Gate, 18 Rabindra Sarani, Kolkata - 700 001.	10	PVT	N.HOME	
255	Bengal Rural Welfare Service Hospital	10, Kendua Main Road, Kol – 84	10	PVT	N.HOME	

DISTRICT WISE LIST OF BEDDED HCUs IN WEST BENGAL

INVENTORY: ANNEXURE - I

Sl. No	Name of the Units.	Address	Current Bed	Organisation	Category General	Category Special
256	City Medical Center	15/3, Hindusthan Road, Kolkata - 29	10	PVT	N.HOME	
257	De's Nursing Home,	5/25/1, Dum Dum Road, Kol - 02	10	PVT	N.HOME	
258	Dr. Mina Mazumdar Seva Mandir	6, Raja S.C. Mullick Road, Kol - 32	10	PVT	N.HOME	
259	Dr. Nihar Munsu Eye Foundation	1/3, Dover Place Kol- 19	10	PVT	N.HOME	
260	Dr. Roy Chowdhury Nursing Home	240, D.H. Road, Kol - 60	10	PVT	N.HOME	
261	East End Nursing Home (P) Ltd.	14, Circus Avenue, Kol - 17	10	PVT	N.HOME	
262	Eve's Clinic & Nursing Home	14F/1A, Dum Dum Road, Kol - 30	10	PVT	N.HOME	
263	Eve's Nursing Home	F-40/A, Mehar Manzil Lane, Kol - 24	10	PVT	N.HOME	
264	Genesis Nursing Home	10, Rajendralal St. Kol - 06	10	PVT	N.HOME	
265	Good Earth Medical Center	P-9' Bhupen Roy Road, Jadu Colony Kol - 34	10	PVT	N.HOME	
266	Good Hope Nursing Home	68, Raja S.C. Mallick Road, Kol - 92	10	PVT	N.HOME	
267	Green Park Nursing Home	9, Netaji Nagar, Green Park, Kalikapur, P.O.: Mukundapur, Kolkata - 144	10	PVT	N.HOME	
268	H.P. Poddar Memorial Cl. & Nursing Home	56/H, Beliaghata Mai n Road, Kol - 10	10	PVT	N.HOME	
269	Jeevan Jyoti Nursing Home	12, Protap Ghosh Lane, Kol - 7	10	PVT	N.HOME	
270	K.D.Cure Nursing & Maternity Home	52, Jodhpur Park, Kol - 68	10	PVT	N.HOME	
271	Kumar Surgical & Laproscopic Clinic, Unit - II	348/47, N.S.C. Bose Road, Kolkata - 700 047	10	PVT	N.HOME	
272	Matri Seva Sadan	P 61/1A, C.G.R. Road, Kol - 43 (Karl Marx Sarani)	10	PVT	N.HOME	
273	Nabadiganta Charitable Hospital	29, Banerjee Para Lane, Kol - 61	10	PVT	N.HOME	
274	Nagarik Swasthya Sangha	9, Tarak Pramanik Road, Kolkata - 6	10	PVT	N.HOME	
275	National Pay Clinic	22/3D, Bright Street, Kol - 17	10	PVT	N.HOME	
276	Netra Sevasram (A Center for Eye Care & Research)	15, Prafulla Sarkar Street, Kolkata - 72	10	PVT	N.HOME	
277	Oinments & Cosmetic India (P) Ltd.	14B, N. N. Dutta Road, Kolkata - 700 040.	10	PVT	N.HOME	
278	Palm Spring Nursing Home	2, Greek Church Road, Kol - 26	10	PVT	N.HOME	
279	Park Site Nusing Home	70A, Purna Das Road, Kol - 29	10	PVT	N.HOME	
280	Park View ClinicPvt. Ltd. (N. Home)	21A, Gora Chand Lane, Kolkata - 14	10	PVT	N.HOME	
281	Popular Nursing Home	5A, Raja Rajnarayan Street, Kol - 9	10	PVT	N.HOME	
282	Premier Nursing Home & Surgical Centre	14B, Anil Roy Road, Kol - 29	10	PVT	N.HOME	
283	Ramesh Chandra Sen Clinic.	P-404/9A, Hemanrt MukherjeeSadan, Kol- 29	10	PVT	N.HOME	
284	Regal Nursing Home	13 - H, Tijjala Lane, Kol - 19	10	PVT	N.HOME	
285	Revival Nursing Home	227A, Rash Behari Avn. Kol - 19	10	PVT	N.HOME	
286	Sakuntala Nursing Home	633, Biren Roy Road, (West), Kol - 61	10	PVT	N.HOME	
287	Santosh Clinic	38U, Sultan Alam Road, Tollygunge Road, Kolkata - 700 033.	10	PVT	N.HOME	

DISTRICT WISE LIST OF BEDDED HCUs IN WEST BENGAL

INVENTORY: ANNEXURE - I

Sl. No	Name of the Units.	Address	Current Bed	Organisation	Category General	Category Special
288	Santoshpur Nursing Home	12, Park Terrace, Kol - 75	10	PVT	N.HOME	
289	Saraju Nursing Home	46/1C B.T. Road, Kol - 02	10	PVT	N.HOME	
290	Sevalaya Nursing Home	4, Abhoy Goho Road, Kol - 6	10	PVT	N.HOME	
291	Sevangan Medical Complex	398/1, N.S.C. Bose Road, Kol - 47	10	PVT	N.HOME	
292	Shakambari Nursing Home	20, Jatindra Mohan Avenue, Kol - 6	10	PVT	N.HOME	
293	Shee Medical Centre	43/A, Mahanirban Road, Kol - 29	10	PVT	N.HOME	
294	Shradha Health Care (P) Ltd.	851, Block - P New Alipore Kol - 13	10	PVT	N.HOME	
295	South View Nursing Home	11, Satyen Roy Road, Kol - 34	10	PVT	N.HOME	
296	Sree Krishna Nursing Home	55, M.G. Road, Kol - 9	10	PVT	N.HOME	
297	Thalassaemia Hospital	19 B, Chetlahat Road, Kol-27	10	PVT	N.HOME	
298	The Mother Nursing Home	39/3B, R. K. Chatterjee Road, Kolkata - 42	10	PVT	N.HOME	
299	The Thallasemia Society of India	48A, Muktarambau Street, Kolkata - 700 007.	10	PVT	N.HOME	
300	Vaishnwi Clinic	9A, Kabir Road, Kol - 26	10	PVT	N.HOME	
301	Vijay Bahadur Infirmary	R - 70A, Garden Reach Road, Kolkata - 24	10	PVT	N.HOME	
302	Stallard Eye Clinic	3B, Congress Exebtion Road, Kol - 17	9	PVT	N.HOME	EYE
303	Blue Cross (Nursing Home)	P-263, C.I.T. Road, Kol - 10	9	PVT	N.HOME	
304	Bowbazar Nursing Home	21, Gangadhar Babu Lane, Kol -12	9	PVT	N.HOME	
305	Care and Cure Nursing Home	8/1, Duff Street, Kol - 6	9	PVT	N.HOME	
306	Citizen Clinic (P) Ltd.	57/1, Garcha Road, Kol - 29	9	PVT	N.HOME	
307	East Land Nursing Home	86A Topsia Road Kol-39	9	PVT	N.HOME	
308	Green View Nursing Home	1/2D, Kabi Md. Iqbal Road, Kol- 23	9	PVT	N.HOME	
309	Khanna Nursing Home	9/1B, M.G. Road, Kol - 9	9	PVT	N.HOME	
310	Mother Nursing Home	39/B, R. K. Chatterjee Road, Kolkata - 700 042.	9	PVT	N.HOME	
311	Prince Nursing Home	37/1B, Hindusthan Road, Kol - 29	9	PVT	N.HOME	
312	V.I.P. Nursing Home	P-244, C.I.T. Scheme VI (M), Kol - 54	9	PVT	N.HOME	
313	Lansdown Eye Center (P) Ltd.	6, Sarat Bose Road, Kolkata - 700 020.	8	PVT	N.HOME	EYE
314	Ashok Laboratory & Nursing Home	30 B, Jodhpur Park, Kol- 68	8	PVT	N.HOME	
315	Dolphin Nursing Home	Kustia Road, Kohinoor Market, Kol - 39	8	PVT	N.HOME	
316	Florid Nursing Home	P-1, C.I.,T. Scheme VI (M), Kol - 54	8	PVT	N.HOME	
317	Kimber Maternity & Nursing Home	14/1, Kimber Street, Kol -17	8	PVT	N.HOME	
318	Love Bailey Nursing Home	617, D.H. Road, Kol - 63	8	PVT	N.HOME	
319	New Nirnoy Nursing Home	2A, Deshapriya Park Road, Kol -29	8	PVT	N.HOME	

DISTRICT WISE LIST OF BEDDED HCUs IN WEST BENGAL

INVENTORY: ANNEXURE - I

Sl. No	Name of the Units.	Address	Current Bed	Organisation	Category General	Category Special
320	North View Nursing Home	247/2C, A.P.C. Road, Kol - 4	8	PVT	N.HOME	
321	Paradise Nursing Home	10/A, Nimchand Moitra St., Kol-35	8	PVT	N.HOME	
322	Hope Clinic	10, Chakrabaria Road (N), Kol - 20	7	PVT	N.HOME	
323	Mira Memorial Clinic (P) Ltd.	P-599, Keyatala Road, Kol – 29	7	PVT	N.HOME	
324	Raha Nursing Home	T-88/1, S. A. Farrooquie Road (Akra) Rd. Kol – 18	7	PVT	N.HOME	
325	Wayside Home & Clinic	93/2, Harighosh Street, Kol – 6	7	PVT	N.HOME	
326	Vivekananda Eye Foundation	99/61, Mahatma Gandhi Road, Kolkata - 700 041.	6	PVT	N.HOME	EYE
327	A M C	11C, Indra Biswas Road, Kolkata - 700 037.	6	PVT	N.HOME	
328	Abdul Wahid Nephrology Center	51A, D. H. Road, Kolkata - 700 038.	6	PVT	N.HOME	
329	Calcutta Maternity Nursing Home	140, Bidhan Sarani, Kol – 6	6	PVT	N.HOME	
330	Doctor's Chamber Nursing Home	8, Dharmatala Street, Kol - 13	6	PVT	N.HOME	
331	Healing Touch Nursing Home	88C, Jatin Bagchi Road, Kol - 29	6	PVT	N.HOME	
332	Janakalyan Nursing Home	266/5A, D. H. Road, Kol - 08	6	PVT	N.HOME	
333	Parivar Seva Sanstha, (Merie Stopes)	Sakherbazar, DH Road, Kol-8	6	PVT	N.HOME	
334	Prem Milan	160, Rabindra Sarani, Kolkata - 700 017.	6	PVT	N.HOME	
335	Prima Orthpedic Center	130 E, Bhattacharya Para Road, P.S.: Thakurpukur, Kolkata - 63	6	PVT	N.HOME	
336	Red Plus Clinic	4, Kali Mohan Banerjee Lane, Cal-25	6	PVT	N.HOME	
337	Santawna Nursing Home	45, Abhedananda Road, Kolkata - 06	6	PVT	N.HOME	
338	Sevayan Nursing Home (Dr.Mrs N.Guha)	46B, Ekbalpur Road, Kol - 23	6	PVT	N.HOME	
339	Amulya Jyoti Eye Foundation	105, Monoharpukur Road, Kolkata - 700 029	5	PVT	N.HOME	EYE
340	Arya Samiti (Eye Micro Surgery Unit)	4, Arya Samity Road, Kolkata - 34	5	PVT	N.HOME	EYE
341	B. B. Eye Foundation,	2/5 Sasrat Bose Road, Kolkata - 700 020	5	PVT	N.HOME	EYE
342	Dakshini Eye Foundation (P) Ltd.	69/1/1/3, Raja S. C. Mullick Road, Kolkata - 700 047	5	PVT	N.HOME	EYE
343	Eye Clinic & Nursing Home	166/C/505 Lake Gardens, Kolkata - 45	5	PVT	N.HOME	EYE
344	Eye Surgery Cheap Nursing Home	34, Satish Mukherjee Road, Kol-26	5	PVT	N.HOME	EYE
345	Nemesis Eye Center	6A, Deshapriya Park (East), Kol - 29	5	PVT	N.HOME	EYE
346	AMRI Clinic	97A, Southern Avn (1st Floor), Kol - 29	5	PVT	N.HOME	
347	Behala Surgical Centre	P-182/A, Unique Park, P.O. & P.S.: Behala, Kol – 34	5	PVT	N.HOME	
348	Benthal Green Medical Center	19/2, Banamali Naskar Road, P.O.: Parnasree, P.S.: Behala, Kol - 700 060.	5	PVT	N.HOME	
349	C.I.T. Medical Centre	29, Hem Chandra Naskar Road, Kol - 10	5	PVT	N.HOME	
350	Care Fertility Solutions (P) Ltd. IVF	2/1B, Mahendra Road, Kolkata - 25	5	PVT	N.HOME	
351	Centre Point Nursing Home	144A, Ashutosh Mukherjee Rd, Kol - 25	5	PVT	N.HOME	

DISTRICT WISE LIST OF BEDDED HCUs IN WEST BENGAL

INVENTORY: ANNEXURE - I

Sl. No	Name of the Units.	Address	Current Bed	Organisation	Category General	Category Special
352	Cosmetic Surgery Clinic & Research Centre	158/2, P.A. Shah Road, Kol - 45	5	PVT	N.HOME	
353	Debdoot Nursing Home	51, Charu Avenue, Kol – 33	5	PVT	N.HOME	
354	Dental Clinic	2, Bajendralal Ganguly Lane, Kol - 33	5	PVT	N.HOME	
355	Dr. B. N. Basu Memorial Clinic, Apollo Nursing Home,	34/B, Jatin Das Road, Kolkata - 700 029	5	PVT	N.HOME	
356	Dr. P.K. Dhar Nursing Home	6/1B, Kyd Street, Kol - 17	5	PVT	N.HOME	
357	East Calcutta Clinic & Nursing Home	11A, Hem Chandra Naskar Rd, Kol - 10	5	PVT	N.HOME	
358	East End Nursing Home (Prop.Jayshree Ray)	P-21, C.I.T. Road, Kol - 14	5	PVT	N.HOME	
359	Elliot Nursing Home	90, Elliot Road, Kolkata - 700 016	5	PVT	N.HOME	
360	Emily Nursing Home	P-205, Ramkrishna Samadhi Rd, Kol – 54	5	PVT	N.HOME	
361	Federation Nursing Home	4, Federation Street, Kol - 9	5	PVT	N.HOME	
362	Fertility Clinic & IVF Research Center	42, Circus Avenue, Kol - 17	5	PVT	N.HOME	
363	Halder Pearl Nursing Home.	3, Dr. A.M.O. Gani Road, Kol - 17(Park Cirs.Market	5	PVT	N.HOME	
364	Khsetra Nath Memorial Clinic (P) Ltd.	5A, Chakraberia Lane, Kol - 20	5	PVT	N.HOME	
365	Kumar Surgical & Laproscopic Clinic	235/3/1, NSC Bose Road, P.S.: Jadavpur, Kolkata - 700 047	5	PVT	N.HOME	
366	Lap Cure Clinic	107/1, Karaya Road, Kol - 17	5	PVT	N.HOME	
367	Life Line Nursing Home	2, Shyamlal Street, Kol - 4	5	PVT	N.HOME	
368	Mandakini Nursing Home	23A, Ekbalpore Lane, Khidderpore, Kol - 23	5	PVT	N.HOME	
369	Medicure Nursing Home	227A, Rash Behari Avenue, Kol - 19	5	PVT	N.HOME	
370	Micro Surgery Day Centre	51B, Garcha Road Kol - 19	5	PVT	N.HOME	
371	Moonlight Nursing Home	198, Bidhan Sarani, Kol - 6	5	PVT	N.HOME	
372	Mukherjee's Clinic & Nursing Home	3C, Nalin Sarkar Street, Kolkata - 700 004.	5	PVT	N.HOME	
373	New Peoples Nursing Home,	93, Baithak Khana Road, Kolkata - 700 009.	5	PVT	N.HOME	
374	Northern Maternity & Nursing Home	13/1/1C, Raja Manindra Road, Kolkata - 37	5	PVT	N.HOME	
375	Nuruddin Nursing Home	39, Mominpur Road, Kol - 23	5	PVT	N.HOME	
376	Orient Nursing Home	4, M.G. Road, Kol - 9	5	PVT	N.HOME	
377	Orthopedic Centre	P/18/1, C.I.T. Scheme VII (M), Kol – 54	5	PVT	N.HOME	
378	Paikpara Maternity and N. Home	6X/1A, Umakanta Sen Lane, Kol – 30	5	PVT	N.HOME	
379	Parivar Seva Sanstha, (Merie Stopes)	48, Gariahat Road, Kol- 19	5	PVT	N.HOME	
380	Sankernath Dialysis Cent, & N.Home	48/4/1A, A.P.C.Mitra Lane (Swiss Park) Kol - 33	5	PVT	N.HOME	
381	Seba Niketan Nursing Home	133A, Lenin Sarani, Kol - 13	5	PVT	N.HOME	
382	Sevac (Mental Hospital & Rehabilitation Center)	135A, Vivekananda Sarani, Thakurpukur, Kol - 63	5	PVT	N.HOME	
383	South City Nursing Home	41/1, Ray Bahadur Road, Kol - 34	5	PVT	N.HOME	

DISTRICT WISE LIST OF BEDDED HCUs IN WEST BENGAL

INVENTORY: ANNEXURE - I

Sl. No	Name of the Units.	Address	Current Bed	Organisation	Category General	Category Special
384	South End Nursing Home	84, Rai Bahadur Road, Kol - 34	5	PVT	N.HOME	
385	Spectrum Clinic	28/B. Shakespeare Sarani, Kol-17	5	PVT	N.HOME	
386	Sushama Nursing Home	P-307, C.I.T. Road, Kol - 54	5	PVT	N.HOME	
387	The Hemophilia Society Calcutta Chapter	Singhbari: Kalikapur: EM Bye Pass: Kol:99	5	PVT	N.HOME	
388	Tiereza Meternity & Nursing Home	14A/1K, Ultadanga Road, Kol - 4	5	PVT	N.HOME	
389	Vidyasagar Nursing Home	P-55, Kanungo Park, Garia, Kol - 84	5	PVT	N.HOME	
390	A.N.Sen Memorial Eye Clinic	2A, Deshapriya Park Road, Kol -29	4	PVT	N.HOME	EYE
391	ArobindaNetralaya Eye Clinic	4A, Rajendra Deb Road, Kol - 07	4	PVT	N.HOME	EYE
392	Dr. Mitra's Eye Clinic	72, Hem Chandra Naskar Road, Kol - 10	4	PVT	N.HOME	EYE
393	Eye Pavilion	6, Russel Street, Kolkata - 71	4	PVT	N.HOME	EYE
394	Suburban Eye Microsurgery Center	130 A, Bhattacharjee para Road, Kol - 63	4	PVT	N.HOME	EYE
395	Diamond View Nursing Home	567, D.H. Road, Kol - 34	4	PVT	N.HOME	
396	Golpark Maternity & Nursing Home	42/7A, Gariahat Road, Kol - 29	4	PVT	N.HOME	
397	Jodhpur Park Nursing & Maternity Home	127, Jodhpur Park, Kol - 68	4	PVT	N.HOME	
398	Lake Nursing Home	66/C, Southern Park, Kol - 29	4	PVT	N.HOME	
399	Nirnay Nursing Home	226 A & B, A.P.C Road, Kol - 04	4	PVT	N.HOME	
400	Parivar Seva Sanstha, (Merie Stopes)	174/8, N.S.C. Bose Rd, Kol - 40	4	PVT	N.HOME	
401	Parivar Seva Sanstha, (Merie Stopes)	100, Aurobindo Sarani,(Hati Bagan), Kol - 06	4	PVT	N.HOME	
402	Sevayan Nursing Home	53A, S. N. Roy Road, Kol - 38	4	PVT	N.HOME	
403	Sunny Nursing Home	14, Suren Roy Road, Kol - 34	4	PVT	N.HOME	
404	Tarangini Nursing Home	567, D.H. Road, Kol - 34	4	PVT	N.HOME	
405	The Royal Nursing Home	J-146/1, Paharpur Road, Kol - 24	4	PVT	N.HOME	
406	Broad View Clinic	42C, Sayed Amir Ali Avenue, Kol - 17	3	PVT	N.HOME	
407	Deshari	99/5/8C, Ballygunge Place, Kolkata - 700 019	3	PVT	N.HOME	
408	Entally Nursing & Maternity Home	51, Dr. Sundari Mohan Avenue, Kolkata - 14	3	PVT	N.HOME	
409	Ghosh Dastidar Inst. for Infertility Res. Pvt Ltd.	208, Rashbehari Avenue, Kol - 29	3	PVT	N.HOME	
410	Green Land Nursing Home	Dr. K.S.Roy Rd, Charu Bhawan, 3rd Fl. Kol - 32	3	PVT	N.HOME	
411	Mother's Home	53A, Bhupen Bose Avenue, Kol - 4	3	PVT	N.HOME	
412	P.M.S. Nursing Home	16/1A, Monilal Banerjee Road, Kol-23	3	PVT	N.HOME	
413	South Calcutta Maternity Home	144, Asutosh Mukherjee Road, Kol - 25	3	PVT	N.HOME	
414	Oculus Eye Clinic & Opticals	P-26B, CIT Road, (Nani Gopal Roy Choudhury Avenue), Kolkata - 700014.	2	PVT	N.HOME	EYE
415	Sanjiban Nursing Home,	130/B, Jhowtala Road, Kol - 17	2	PVT	N.HOME	

DISTRICT WISE LIST OF BEDDED HCUs IN WEST BENGAL

INVENTORY: ANNEXURE - I

Sl. No	Name of the Units.	Address	Current Bed	Organisation	Category General	Category Special
416	De's Eye Center	(2nd Floor) S. mP. Mukherjee Road, Kolkata - 700 026	1	PVT	N.HOME	EYE
417	Eye Microsurgery & Day Care Center	5B, Ashutosh Mukherjee Road, Kolkata - 20	1	PVT	N.HOME	EYE
418	Himalaya Vision Care Center	146, R. B. Avenue, Kolkata - 700 029.	1	PVT	N.HOME	EYE
419	Princess Nursing Home,	15/1B, Ballygunge Station Rd. Kol - 19	1	PVT	N.HOME	
420	Seva Kendra Calcutta	52B, Radhanath Chowdhury Road,Kolkata - 700 015	100	PVT	Pvt Hspitl	
		TOTAL NUMBER OF BEDS IN KOLKATA DISTRICT:	28041			
MALDA						
1	District Hospital -Malda	P.O. Malda, Dist. Malda.	600	GOVT	DH	
2	Raja Sarat Ch. T.B. Hospital	English Bazar , Malda	30	GOVT	SGH	TB
3	Chanchal Rural Hospital	Chanchal - I, Chanchal, Dist. Malda, PIN - 732123	68	GOVT	RH	
4	Harishchandrpur Rural Hospital	Harishchandrapur - I, Harishchandrapur, Malda	65	GOVT	RH	
5	Gazole Rural Hospital	Gazole, Malda	30	GOVT	RH	
6	Bamangola (Maheshpur) Rural Hospital	Bamangola, Maheshpur, Malda	25	GOVT	RH	
7	Manikchak (Enayetpur) Rural Hospital	Manikchak, Malda	25	GOVT	RH	
8	R. N. Roy (Bulbulchandi) Rural Hospital	Habibpur, Bulbulchandi, Malda	25	GOVT	RH	
9	Araidanga BPHC	Ratua - II, Ariadanga, Malda	15	GOVT	BPHC	
10	Bangitola (Sadipur) BPHC	Kaliachak - II, Bangitola, Malda	15	GOVT	BPHC	
11	Bedrabad BPHC	Kaliachak - III, Baishnabnagar, Malda	15	GOVT	BPHC	
12	Hatimari BPHC	Gazole, Hatimari, Malda	15	GOVT	BPHC	
13	Malatipur BPHC	Chanchal - II, Malatipur, Maldah	15	GOVT	BPHC	
14	Masaldabajar (Daulatpur) BPHC	Harishchandrapur - II, Kariali, Malda	15	GOVT	BPHC	
15	Milki BPHC	English Bazar ,Milki, Malda	15	GOVT	BPHC	
16	Ratua BPHC	Ratua - I, Ratua, Malda	15	GOVT	BPHC	
17	Silampur BPHC	Kaliachak - I, Kaliachak, Malda	15	GOVT	BPHC	
18	Moulpur BPHC	Old Malda, Malda	15	GOVT	PHC	
19	Bahadurpur (Baidyapur) PHC	Habibpur, Manikora, Malda	10	GOVT	PHC	
20	Debipur PHC	Ratua - I, Debipur, Malda	10	GOVT	PHC	
21	Golapgunj PHC	Kaliachak - III, Golapgunj, Malda	10	GOVT	PHC	
22	Kharba PHC	Chanchal - I, Chandrapara, Malda	10	GOVT	PHC	
23	Pandua PHC	Gazole, Kutubshahar, Malda	10	GOVT	PHC	
24	Ranipur (Sahazanpur) PHC	Gazole, Purba Ranipur, Malda	10	GOVT	PHC	
25	Sujapur PHC	Kaliachak - I, Choto Sujapur, Malda	10	GOVT	PHC	

DISTRICT WISE LIST OF BEDDED HCUs IN WEST BENGAL

INVENTORY: ANNEXURE - I

Sl. No	Name of the Units.	Address	Current Bed	Organisation	Category General	Category Special
26	Uttar Noapara (Gobindapur) PHC	Bamangola, Nalagola, Malda	10	GOVT	PHC	
27	Bhaluka PHC	Harishchandrapur - II, Bhaluka Bajar, Malda	6	GOVT	PHC	
28	Borai PHC	Harishchandrapur - I, Borai, Malda	6	GOVT	PHC	
29	Chandipur PHC	English Bazar ,Madapur, Malda	6	GOVT	PHC	
30	Hardamnagar PHC	Harishchandrapur - II, Talbhangura, Malda	6	GOVT	PHC	
31	Jatradanga (Popra) PHC	Old Malda, Jatradanga, Malda	6	GOVT	PHC	
32	Kumarganj PHC	Ratua - II, Kumarganj, Malda	6	GOVT	PHC	
33	Mahadipur PHC	English Bazar ,Mahadipur, Malda	6	GOVT	PHC	
34	Mahananda PHC	Ratua - I, Mahananda, Malda	6	GOVT	PHC	
35	Mathabari PHC	Kaliachak - II, Mathabari, Malda	6	GOVT	PHC	
36	Nadasik PHC	Chanchal - I, Singila, Maldah	6	GOVT	PHC	
37	Sultanganj PHC	Ratua - II, Kholsona, Malda	6	GOVT	PHC	
38	Babupur PHC	Gazole, Babupur, Malda	4	GOVT	PHC	
39	Bhimgola PHC	Harishchandrapur - I, Bhimgola, Malda	4	GOVT	PHC	
40	Bhutnidiara PHC	Manikchak, Bhutni, Malda	4	GOVT	PHC	
41	Chandrapara PHC	Chanchal - II, Chandrapara, Maldah	4	GOVT	PHC	
42	Kasimpur PHC	Bamangola, Ashrampur, Malda	4	GOVT	PHC	
43	Khempara PHC	Chanchal - II,Chorolmoni, Malda	4	GOVT	PHC	
44	Khusida PHC	Harishchandrapur - I, Khusida, Malda	4	GOVT	PHC	
45	Kumbhira (Nurnagar) PHC	Kaliachak - III, Sabdalpur, Malda	4	GOVT	PHC	
46	Mathurapur PHC	Manikchak, Mathurapur, Malda	4	GOVT	PHC	
47	Narpur PHC	Manikchak, Narpur, Malda	4	GOVT	PHC	
48	Nayagram (Hamidpur) PHC	Kaliachak - II, Rajnagar, Malda	4	GOVT	PHC	
49	Rishipur PHC	Habibpur, Gourimari, Malda	4	GOVT	PHC	
50	Samshi PHC	Ratua - I, Samshi, Malda	4	GOVT	PHC	
51	Muchia PHC	Old Malda, Mahadevpur, Malda	2	GOVT	PHC	
52	Narayanpur PHC	Kaliachak - I, Pirojpur, Malda	2	GOVT	PHC	
53	Noada - Jodupur PHC	Kaliachak - I, Jadupur, Malda	2	GOVT	PHC	
54	Malda District Jail Hospital	English Bazar , Malda	2	GOVT	SGJ	
55	English Bazar Police Hospital	English Bazar , Malda	27	GOVT	SGP	
56	Matri Sadan	Vivekananda Pally, Malda	18	GOVT	MUNI	MNTY
57	NTPC. Hospital	N.T.P.C. / Farakka, P. O. : Pubaun, Malda - 732 215	35	GOVT	N.T.P.C.	

DISTRICT WISE LIST OF BEDDED HCUs IN WEST BENGAL

INVENTORY: ANNEXURE - I

Sl. No	Name of the Units.	Address	Current Bed	Organisation	Category General	Category Special
58	Eastern Rly Hospital, Malda Town	Jhaljhalia, English Bazar , Malda	100	GOVT	RLY	
59	Malda Nursing Home	B. G. Road, P.O.: Makdumpur,P.S. Englishbazar, Dist.Malda, PIN- 732 103	60	PVT	N.HOME	
60	Dishari Health point Ltd.	19, B. G. Road (Near Rathbari), P. O. Mokdumpur	30	PVT	N.HOME	
61	North Bengal Nursing Home	K. J. Sanyal Road, Malda	30	PVT	N.HOME	
62	Thakur Sitaram Seva Kendra	Sarbamangolapally, Malda	30	PVT	N.HOME	
63	Roy Medical Institute	Malda	25	PVT	N.HOME	
64	Dolphin Nursing Home	Gazole, Malda	20	PVT	N.HOME	
65	Malda Medical Centre (P) Ltd.	2A/3 K.J. Sanyal Road, Mokdumpur, Malda	20	PVT	N.HOME	
66	Square Nursing Home	3, No. Govt. Colony, Malda	20	PVT	N.HOME	
67	Susama Trripathy Memorial Nursing Home	Jhaljhalia, Malda	20	PVT	N.HOME	
68	Usha Nursing Home	B. G. Road, Malda	20	PVT	N.HOME	
69	Chowdhury Clinic & Nursing Home	Womens` College Road, (New S. G. Sen Sarani), Pirojpur, Malda	15	PVT	N.HOME	
70	Sheshraj Medicare	N. H. - 34, Jadupur, P.O.: Kadambari, P.S.: Englishbazar, Malda	15	PVT	N.HOME	
71	Angel Nursing Home	Sardarghat, P.O.: Nageswarpur, Mangalbari, Malda	10	PVT	N.HOME	
72	Mahananda Nursing Home	Bandh Rd, Mokdumpur, Malda	10	PVT	N.HOME	
73	Malda Orthopedic Nursing Home	Pirojpur, Malda	10	PVT	N.HOME	
74	Prakash Nursing Home	Rajnagar, Bajbari, Malda	10	PVT	N.HOME	
75	B.K.G. Eye Institute	Gour road, P.O.: Mokdompur, Malda	5	PVT	N.HOME	EYE
76	Benojir Seva Bhawan	Mandirpara, P.O. & P.S.: Harishchandrapur, Malda	5	PVT	N.HOME	
77	Dristi Nursing Home	Najrul Sarani, Malda	5	PVT	N.HOME	
78	Fouzder Nursing Home	Manaskamasna Rd, Malda	5	PVT	N.HOME	
79	Life Line Polyclinic Nursing Home	173/220, K. J. Sanyal Rd., Malda	5	PVT	N.HOME	
80	Sevayan Nursing Home	Hospital More, Chanchal, Malda	5	PVT	N.HOME	
81	Fertility Clinic & IVF Res. Cent.& Maternity	Mokdumpur, Malda	3	PVT	N.HOME	
		TOTAL NUMBER OF BEDS IN MALDA DISTRICT:	1782			
MURSHIDABAD						
1	District Hospital – Murshidabad	P.O. Berahampur, Dist. Murshidabad, Pin : 742 101	391	GOVT	DH	
2	S.D. Hospital – Jangipore	P.O. Raghunathganj, Murshidabad	250	GOVT	SD	
3	S.D. Hospital – Kandi	P.O. Kandi, Murshidabad	250	GOVT	SD	
4	S.D. Hospital – Lalbagh	P.O. & Dist. Murshidabad	206	GOVT	SD	
5	S.D. Hospital – Domkol	PO. Domkol, PS. Rashulpur, Dist. Murshidabad.PIN - 742 303	68	GOVT	SD	
6	Sub Division Hospital, Domkol	Domkal, Murshidabad	15	GOVT	SD	

DISTRICT WISE LIST OF BEDDED HCUs IN WEST BENGAL

INVENTORY: ANNEXURE - I

Sl. No	Name of the Units.	Address	Current Bed	Organisation	Category General	Category Special
7	Berhampore General Hospital	P.O. Baharampore, Murshidabad	225	GOVT	SG	
8	Christiya Seva Sadan	P.O. & P.S.: Jiaganj, Murshidabad	20	GOVT	SGH	
9	Khargram Rural Hospital	P.O. Khargram, Murshidabad	60	GOVT	RH	
10	Amtala Rural Hospital	P.O. Amtala, Murshidabad	50	GOVT	RH	
11	Amtala Rural Hospital	Vill & P.O.: Amtala, P.S. Nowda, Dist. Murshidabad, PIN - 742121	50	GOVT	RH	
12	Krishnapur Rural Hospital	P.O. Krishnapur, Murshidabad	50	GOVT	RH	
13	Beldanga Rural Hospital	P.O. Beldanga, Murshidabad	30	GOVT	RH	
14	Burwan Rural Hospital	P.O. Burwan, Murshidabad	30	GOVT	RH	
15	Islampur Rural Hospital	P.O. Islampur, Murshidabad	30	GOVT	RH	
16	Sagardighi Rural Hospital	P.O. Sagardighi, Murshidabad	30	GOVT	RH	
17	Jiaganj Rural Hospital	P.O. Jiaganj, Murshidabad	25	GOVT	RH	
18	Sadikhan's Dear Rural Hospital	P.O. Sudikhan's Dear, Murshidabad	25	GOVT	RH	
19	Taraf Rasulpur BPHC	Murshidabad	68	GOVT	BPHC	
20	Beldanga BPHC	P.O. Beldanga, Murshidabad	25	GOVT	BPHC	
21	Haridharpara BPHC	P.O. Haridharpara, Murshidabad	20	GOVT	BPHC	
22	Ahira BPHC	P.O. Ahira, Murshidabad	15	GOVT	BPHC	
23	Anupnagar BPHC	P.O. Dhulian, Samserganj, Murshidabad	15	GOVT	BPHC	
24	Bharatpur BPHC	P.O. Bharatpur, Murshidabad	15	GOVT	BPHC	
25	Gokarna BPHC	P.O. Gokarna, Kandi, Murshidabad	15	GOVT	BPHC	
26	Karna Subarna BPHC	P.O. Karna Subarna, Murshidabad	15	GOVT	BPHC	
27	Mahesail BPHC	P.O. Parulia via Aurangabad, Murshidabad	15	GOVT	BPHC	
28	Nabagram BPHC	P.O. Nabagram, Murshidabad	15	GOVT	BPHC	
29	Nashipur BPHC	P.O. Nashipur, Murshidabad	15	GOVT	BPHC	
30	Godhanpara (Raninagar) BPHC	P.O. Raninagar, Murshidabad	15	GOVT	BPHC	
31	Saktipur BPHC	P.O. Saktipur, Murshidabad	15	GOVT	BPHC	
32	Salar BPHC	P.O. Salar, Murshidabad	15	GOVT	BPHC	
33	Farakka BPHC	P.O. Farakka Barage, Murshidabad	10	GOVT	BPHC	
34	Kanapukur BPHC	P.O. Bhagwangola, Murshidabad	10	GOVT	BPHC	
35	Teghari BPHC	P.O. Teghari, Murshidabad	10	GOVT	BPHC	
36	Rajnagar BPHC	Raghunzathgunj - I, P.O. Rajnagar, Murshidabad	6	GOVT	BPHC	
37	Azimganj PHC	P.O. Azimganj, Murshidabad	15	GOVT	PHC	
38	Gangadhari PHC	P.O. Gangadhari, Murshidabad	15	GOVT	PHC	

DISTRICT WISE LIST OF BEDDED HCUs IN WEST BENGAL

INVENTORY: ANNEXURE - I

Sl. No	Name of the Units.	Address	Current Bed	Organisation	Category General	Category Special
39	Baharan PHC	P.O. Baruipara, Murshidabad	10	GOVT	PHC	
40	Bahutali PHC	P.O. Bahutali, Murshidabad	10	GOVT	PHC	
41	Beniagram PHC	P.O. Beniagram, Farkka, Murshidabad	10	GOVT	PHC	
42	Chourigachha PHC	P.O. Satui, Murshidabad	10	GOVT	PHC	
43	Ghoramara-Mohismara PHC	P.O. Mohismara, Murshidabad	10	GOVT	PHC	
44	Hilora PHC	P.O. Hilora, Murshidabad	10	GOVT	PHC	
45	Jajan PHC	P.O. Jajan, Murshidabad	10	GOVT	PHC	
46	Jhilli PHC	Srikantabati, Gopalnagar, P.O. & P.S.: Raghunathganj, Mursidabad	10	GOVT	PHC	
47	Jitpur PHC	P.O. Jitpur, Murshidabad	10	GOVT	PHC	
48	Margram PHC	P.O. Margram, Murshidabad	10	GOVT	PHC	
49	Panchthupi PHC	P.O. Panchthupi, Murshidabad	10	GOVT	PHC	
50	Parulia PHC	P.O. Dehiparulia, Murshidabad	10	GOVT	PHC	
51	Patkabari PHC	P.O. Patkabari, Murshidabad	10	GOVT	PHC	
52	Ramnagar Bachra PHC	P.O. Bachra, Murshidabad	10	GOVT	PHC	
53	Sundarpur PHC	P.O. Sundarpur, Murshidabad	10	GOVT	PHC	
54	Andulberia PHC	P.O. Nazipur, Murshidabad	6	GOVT	PHC	
55	Arjunpur PHC	P.O. Arjunpur, Farakka, Murshidabad	6	GOVT	PHC	
56	Aurangabad PHC	P.O. Dafahat, Murshidabad	6	GOVT	PHC	
57	Bahara PHC	P.O. Bahara, Kandi, Murshidabad	6	GOVT	PHC	
58	Baje-Gajipur PHC	P.O. Kassimnagar, Murshidabad	6	GOVT	PHC	
59	Bilpocha Kopra PHC	P.O. Nabipur, Murshidabad	6	GOVT	PHC	
60	Choan PHC	P.O. Choan, Murshidabad	6	GOVT	PHC	
61	Habaspur PHC	P.O. Habaspur, Murshidabad	6	GOVT	PHC	
62	Hatinagar PHC	P.O. Hatinagar, Murshidabad	6	GOVT	PHC	
63	Herampur PHC	P.O. Herampur, Murshidabad	6	GOVT	PHC	
64	Hurshi PHC	P.O. Maricha, Murshidabad	6	GOVT	PHC	
65	Kagram PHC	P.O. Kagram, Murshidabad	6	GOVT	PHC	
66	Katlamari PHC	P.O. Katlamari, Murshidabad	6	GOVT	PHC	
67	Kiriteswari PHC	P.O. Kiriteswari, Murshidabad	6	GOVT	PHC	
68	Kolan-Radhakantapur PHC	P.O. Kolan Radhakantapur, Murshidabad	6	GOVT	PHC	
69	Krishnapur-Dinurpara PHC	P.O. Krishnapur-Dinurpara, Murshidabad	6	GOVT	PHC	
70	Kuli PHC	P.O. Kuli, Murshidabad	6	GOVT	PHC	

DISTRICT WISE LIST OF BEDDED HCUs IN WEST BENGAL

INVENTORY: ANNEXURE - I

Sl. No	Name of the Units.	Address	Current Bed	Organisation	Category General	Category Special
71	Mahula PHC	P.O. Gopinathpur, Murshidabad	6	GOVT	PHC	
72	Mohammadpur PHC	P.O. Adikantapur, Murshidabad	6	GOVT	PHC	
73	Monigram PHC	P.O. Monigram, Murshidabad	6	GOVT	PHC	
74	Palsanda PHC	P.O. Palsanda More, Murshidabad	6	GOVT	PHC	
75	Panchgram PHC	P.O.Panchgram, Murshidabad	6	GOVT	PHC	
76	Purandarpur PHC	P.O. Purandarpur, Kandi, Murshidabad	6	GOVT	PHC	
77	Simgeswari Gouripur PHC	P.O. Gouripur, Murshidabad	6	GOVT	PHC	
78	Simulia PHC	P.O. Dutta Barutia, Murshidabad	6	GOVT	PHC	
79	Talibpur PHC	P.O. Talibpur, Murshidabad	6	GOVT	PHC	
80	Tungi PHC	P.O. Tungi, Murshidabad	6	GOVT	PHC	
81	Amirabad PHC	P.O. Nimgram-Beluri, Murshidabad	4	GOVT	PHC	
82	Amlai PHC	P.O. Amlai, Murshidabad	4	GOVT	PHC	
83	Bagirapara PHC	P.O., Rasulpur, Murshidabad	4	GOVT	PHC	
84	Chaitanyapur PHC	P.O. Chaitanyapur, Murshidabad	4	GOVT	PHC	
85	Dangapara PHC	P.O. Hasanpur, Murshidabad	4	GOVT	PHC	
86	Faridpur PHC	P.O. Faridpur, Murshidabad	4	GOVT	PHC	
87	Fulpur PHC	P.O. Fulpur, Murshidabad	4	GOVT	PHC	
88	Garaimari PHC	P.O. Garaimari, Murshidabad	4	GOVT	PHC	
89	Kharjuna (Sabaldaha) PHC	P.O. Kharjuna, Murshdabad	4	GOVT	PHC	
90	Lalkuthi PHC	P.O. Dahapara,	4	GOVT	PHC	
91	Rajarampur PHC	P.O. Rajarampur, Murshidabad	4	GOVT	PHC	
92	Sabdarnagar, PHC	P.O. Sabdarnagar, Murshidabad	4	GOVT	PHC	
93	Sagarpara, PHC	P.O., Sagarpara, Murshidabad	4	GOVT	PHC	
94	Sompara PHC	P.O. Sompara, Murshidabad	4	GOVT	PHC	
95	Suryapur PHC	P.O. Dhanpatganj, Murshidabad	4	GOVT	PHC	
96	Tenya PHC	P.O. Tenya, Murshidabad	4	GOVT	PHC	
97	Barala PHC	P.O. Barala, Murshidabad	2	GOVT	PHC	
98	Bhagirathpur PHC	P.O. Bhagirathpur, Murshidabad	2	GOVT	PHC	
99	Gankar PHC	P.O. Gankar, Murshidabad	2	GOVT	PHC	
100	Indrani PHC	P.O. Indrani, Murshidabad	2	GOVT	PHC	
101	Kendua PHC	P.O. Srimantapu, Farakka, Murshidabad	2	GOVT	PHC	
102	Lakshmikantapur PHC	P.O. Lakshmikantapur, Kandi, Murshidabad	2	GOVT	PHC	

DISTRICT WISE LIST OF BEDDED HCUs IN WEST BENGAL

INVENTORY: ANNEXURE - I

Sl. No	Name of the Units.	Address	Current Bed	Organisation	Category General	Category Special
103	Oper-orahar PHC	P.O. Sundarpur, Murshidabad	2	GOVT	PHC	
104	Putimari PHC	P.O. Putimari, Samserganj, Murshidabad	2	GOVT	PHC	
105	Sarbangapur PHC	P.O.Sarbangapur, Murshidabad	2	GOVT	PHC	
106	Uttar Mahammadpur PHC	P.O. Uttar Mahammadpur, Samserganj, Murshidabad	2	GOVT	PHC	
107	Berhampore Mental Hospital	P.O. Baharampore, Murshidabad	350	GOVT	MNH	
108	Berhampore Central Correctional Home	P.O. Baharampore, Murshidabad	62	GOVT	SGJ	
109	Berhampore Police Hospital	P.O. Baharampore, Murshidabad	68	GOVT	SGP	
110	Borstal Jail Hospital	P.O. Baharampore, Murshidabad	10	GOVT	SGP	
111	Home for Lunatic Vagrant	P.O. Mahalandi, Murshidabad	8	GOVT	SGV	
112	Bhagirathi Maternity & Nursing Home	128/B, Bishnupur Road, Cossimbazar, Murshidabad	5	GOVT	N.HOME	MNTY
113	Central Hospital for Biri Workers , Dhuliyon	Tartapur, P.O.: Malancha, Murshidabad	50	GOVT	CG	
114	Farakka Barrage Hospital	P.O. Farakka, Murshidabad	50	GOVT	CG	
115	NTPC Hospital	Farraka , Murshidabad	35	GOVT	CG	
116	Azimganj Rly. Hospital	Azimganj, Murshidabad	3	GOVT	RLY	
117	Gitaram Hospital (P) Ltd.	Vill. & P.O.: Radharghat, P.S.: Berhampore, Murshidabad	104	PVT	N.HOME	
118	Jiaganj Chirstiya Seva Sadan	P.O.: Jiaganj, Murshidabad	50	PVT	N.HOME	
119	Murshidabad Nursing Home & Diagnostic Centre (P) Ltd.,	P.O.: Kashimbazar, P.S.: Berhampore, Murshidabad	40	PVT	N.HOME	
120	R. N. Tagore Diagnostic & Medical Center	C. R. Das Road, P.O. & P.S.: Berhampore, Murshidabad	30	PVT	N.HOME	
121	Debendra Narayan Sankar Charitable Hospital	Kondolia, P.O.: Parulia, P.S.: Suti, Murshidabad	25	PVT	N.HOME	
122	Laldighi Nursing Home	71, R.N. Tagore Road, Laldighi, Baharampur, Murshidabad	25	PVT	N.HOME	
123	Gorabazar Sahid Kshudiram Pathagar (Eye Operation Division)	39/1, Radhaballavpara Lane, P.O.: Khagra, Baharampore, Murshidabad	20	PVT	N.HOME	EYE
124	Jeevandeep Special Care & Diagnostic Center	Bhakari, Berhampore, Murshidabad	20	PVT	N.HOME	
125	Lions Jangipore Sevanidhi	Ghorsala, Raghunathganj, Murshidabad	20	PVT	N.HOME	
126	Murshidabad Advance Nursing Home & Research Institute	Kadbeltala, Cossimbazar, Murshidabad	20	PVT	N.HOME	
127	Murshidabad Institute for Ortho. & Traumacare	P.O.: Chaltiya Bhakuri, Berhampore, Murshidabad	20	PVT	N.HOME	
128	Susrut Eye Foundation & Research Center	37/2 & 37/3, Babul Bose Road, P.O.: Berhampore, Murshidabad	20	PVT	N.HOME	
129	Lila Sevayan Nursing Home	13/9, A. C. Road, P. O. Khagra, Berhampore, Murshidabad	15	PVT	N.HOME	
130	Rainbow Nursing Home	277, Vivekananda Road, Ratanpur, Lalbagh, P.O. & Dist. Murshidabad	15	PVT	N.HOME	
131	Life Line	37, R. N. Tagore Road, Berhampore, Murshidabad	12	PVT	N.HOME	
132	Aesthetic Nursing Home	G. T. Road (W), Kumarpur, Asansol, Burdwan	10	PVT	N.HOME	
133	Arogya Diagnostic & Treatment Centre	37/2, Babul Bona Road, P.O. Baharampur, Murshidabad	10	PVT	N.HOME	
134	Ash Shefa Nursing Home,	29/1/B, K.K. Banerjee Road, Gorabazar, P.O. & P.S.: Baharampur,	10	PVT	N.HOME	

DISTRICT WISE LIST OF BEDDED HCUs IN WEST BENGAL

INVENTORY: ANNEXURE - I

Sl. No	Name of the Units.	Address	Current Bed	Organisation	Category General	Category Special
135	Bari Seva Niketan	83/1, Old Police Line Road, Gorabazar, P.O. Baharampur, Murshidabad	10	PVT	N.HOME	
136	Berhampur Maternity & Nursing Home	44/3, K.N. Road, P.O. & P.S.: Baharampur, Murshidabad	10	PVT	N.HOME	
137	Bhaduri Nursing Home	30, Radhika Mohan Sen Road, P.O. & P.S.: Berhampore, Murshidabad	10	PVT	N.HOME	
138	Bishnu Chandra Nursing Home	48, Radhika Mohan Sen Road, P.O. Baharampur, Murshidabad	10	PVT	N.HOME	
139	Care Land Nursing Home	155, Pilkhana Road, P.O. Baharampore, Murshidabad	10	PVT	N.HOME	
140	Care Line Nursing & Maternity Home	155, Pilkhana Road, Ranibagan, P.O. & P.S.: Baharampore, Murshidabad	10	PVT	N.HOME	
141	Diamond Nursing Home	New Hospital Road, Jugi Para, SRF College, P.S: Beldanga, Murshidabad	10	PVT	N.HOME	
142	Domkal Nursing Home	Domkal, Murshidabad	10	PVT	N.HOME	
143	Eden Nursing Home	152, Vivekananda Road, Lalbagh, P.O. & Dist, Murshidabad	10	PVT	N.HOME	
144	Green View Nursing Home	41, Swaranamoyee Road, P.O. Baharampur, Murshidabad	10	PVT	N.HOME	
145	Kabita Maternity & Nursing Home	Kandi Main Road, Kandi, Murshidabad	10	PVT	N.HOME	
146	Lalbagh Nursing Home	185, Kalandarbagh, Golapbagh, Lalbagh, Murshidabad	10	PVT	N.HOME	
147	Laldighi Seva Kendra Nursing Home	6, R.N. Tagore Road, Laldighi, Baharampore, Murshidabad	10	PVT	N.HOME	
148	Micro Surgery Nursing Home	46, Babulbona Road, Madhupur, Baharampur, Murshidabad	10	PVT	N.HOME	
149	Mordern Nursing Home	Lalbagh Murshidabad	10	PVT	N.HOME	
150	Motherland Nursing Home	Srikantabati, Gopalnagar, P.O. & P.S.: Raghunathganj, Mursidabad	10	PVT	N.HOME	
151	New Belview Nursing Home	Bablabona, P.O.: P.T. Rosulpur, P.S: Domkal, Murshidabad	10	PVT	N.HOME	
152	New Central Nursing Home	45, Naya Sarak Road, Gorabazar, Baharampur, Murshidabad	10	PVT	N.HOME	
153	New Domkol Nursing Home	Hospital More, Domkol, Murshidabad	10	PVT	N.HOME	
154	New Eden Nursing Home	Lalbagh Murshidabad	10	PVT	N.HOME	
155	New Nightangle Nursing Home	77, Vivekananda Road, Lalbagh, P.O. & Dist. Murshidabad	10	PVT	N.HOME	
156	New Rana View Nursing Home	Vill. & P.O. Domkol, Murshidabad	10	PVT	N.HOME	
157	Sabnam Clinic	Soudaganj, P.O. Jiaganj, Murshidabad	10	PVT	N.HOME	
158	Sabuj Health Clinic Nursing Home	Bablabona, P.O.: P. T. Rosulpur, P.S.: Domkal, Murshidabad	10	PVT	N.HOME	
159	Sathi Nursing Home	Gharighat, P.O. Raghunathganj, Murshidabad	10	PVT	N.HOME	
160	Seva Nursing Home	Garighat Road, P.O. & P.S.: Raghunathganj, Murshidabad	10	PVT	N.HOME	
161	Sevasadan Nursing Home	67, R.N. Tagore Road, P.O. & P.S.: Baharampur, Murshidabad	10	PVT	N.HOME	
162	Soma Health Care Nursing Home	Boxipurghat, Domkol, Murshidabad	10	PVT	N.HOME	
163	Surgicare Nursing Home	41, Swarnamoyee Road, Berhampore, Murshidabad	10	PVT	N.HOME	
164	The Chambers Bhaduri Nursing Home	30, Radhika Mohan Sen Road, P.O. Baharampur, Murshidabad	10	PVT	N.HOME	
165	Uma Seva Niketan Nursing Home	189/2, Netaji Road, P.O. Khagra, P.S.: Berhampore, Murshidabad	10	PVT	N.HOME	
166	Dreamland Diagnostic & Central Nursing Home	Islampur, Nashiyatpara, P.O.: Islampur, Murshidabad	6	PVT	N.HOME	

DISTRICT WISE LIST OF BEDDED HCUs IN WEST BENGAL

INVENTORY: ANNEXURE - I

Sl. No	Name of the Units.	Address	Current Bed	Organisation	Category General	Category Special
167	Maya Nursing Home	Kadamsharif, Roshanbag, P.O. & Dist.: Murshidabad	6	PVT	N.HOME	
168	Paradise Nursing Home	Vill. & P.O.: Barua, P.S.: Beldanga, Murshidabad	6	PVT	N.HOME	
169	Mira Eye Care	Vill.: Gopalnagar, P.O.: Raghunathganj, Murshidabad	5	PVT	N.HOME	EYE
170	Amtala Nursing Home	Amtala, P.S.: Nawda, Murshidabad	5	PVT	N.HOME	
171	Arogya Nursing Home	Kandi Kalibari Road, Kandi, Murshidabad	5	PVT	N.HOME	
172	Beldanga Nursing Home & Diagnostic Center	P.O. & P.S.: Beldanga, Murshidabad	5	PVT	N.HOME	
173	Bharat Nursing Home	Joyrampur, P.O. & P. S.: Domkal, Murshidabad	5	PVT	N.HOME	
174	Day Night Nursing Home	Vill. & P.O.: Shikhpara, Raninagar, Murshidabad	5	PVT	N.HOME	
175	Debandra Nursing Home	25/1, Siris Chandra Nandi Road, Berhampore, Murshidabad	5	PVT	N.HOME	
176	Dhuliyon Nursing Home	Dhuliyon (Near Biswas Market), P.O.: Dhuliyon, P.S.: Samsorganj,	5	PVT	N.HOME	
177	Dolphin Nursing Home	Rosulpur, Domkol, Murshidabad	5	PVT	N.HOME	
178	Dr. Kundu's Nursing Home	24/1, K. N. Road, Ranibagan, P.O. & P.S.: Baharampur, Murshidabad	5	PVT	N.HOME	
179	Godhanpara Nursing Home	P.O.: Godhanpara, P.S.: Raminagore, Baharampur, Murshidabad	5	PVT	N.HOME	
180	Green Land Nursing Home	Vill & P.O.: Bhabta, P.S.: Beldanga, Murshidabad	5	PVT	N.HOME	
181	Hasaniat Nursing Home	Raninagar, Murshidabad	5	PVT	N.HOME	
182	Jaman Nursing Home	Rambagh, PO. & PS. Bhagwangola, Murshidabad	5	PVT	N.HOME	
183	Janaseba Nursing Home	Amtala, P.S.: Nawda, Mursidabad	5	PVT	N.HOME	
184	Jeebandeep Nursing Home	Hariahrpara, Murshidabad	5	PVT	N.HOME	
185	Khanam Nursing Home	Agimgaunjgola, Domkal, Murshidabad	5	PVT	N.HOME	
186	Kundu Clinic Nursing Home	24/1, Pilkhana Road, Berhempore, Murshidabad	5	PVT	N.HOME	
187	Life Line Nursing Home	Old B.D.O. Office, P.O. & P.S.: Domkal, Murshidabad	5	PVT	N.HOME	
188	Lions Club of Berhampore,	Cantonment Road, Berhampore, Murshidabad	5	PVT	N.HOME	
189	Mazumder's Nursing Home	162/1, R.N. Tagore Road, Laldighi, P.O. Baharampur, Murshidabad	5	PVT	N.HOME	
190	Murshidabad Nursing Home & Diagnostic Centre (P) Ltd.,	Kadbeltala (Keshobnagar), Jalangi, Murshidabad	5	PVT	N.HOME	
191	New Dolphin Nursing Home	Vill.: Chunapur, P.O.; Berhampore, Murshidabad	5	PVT	N.HOME	
192	New Life Line Nursing Home	Vill. & P.O.: Sadkhan's Dearh, Jalangi, Murshidabad	5	PVT	N.HOME	
193	New Motherland Nursing Home	P.O. & P.S.: Domkal, Murshidabad	5	PVT	N.HOME	
194	New Nivedita Nursing Home	75, Vivekananda Raod. Lalbagh, P.O. & P.S.: Murshidabad,	5	PVT	N.HOME	
195	New Subarban Nursing Home	46, Babulbona Road, Madhupur, Baharampur, Murshidabad	5	PVT	N.HOME	
196	Paradise Nursing Home	Raninagar, Murshidabad	5	PVT	N.HOME	
197	Seba Nursing Home	54/1/2, N. B. Lane Berhampore, Mursidabad	5	PVT	N.HOME	
198	Sefa Nursing Home	Vill & P.O.: Amtala, Nowda, Murshidabad	5	PVT	N.HOME	

DISTRICT WISE LIST OF BEDDED HCUs IN WEST BENGAL

INVENTORY: ANNEXURE - I

Sl. No	Name of the Units.	Address	Current Bed	Organisation	Category General	Category Special
199	Seva Niketan Nursing Home	Chunapur, P.O. Baharampur, Murshidabad	5	PVT	N.HOME	
200	Sri Debendra Nursing Home	25/1, Sri Srish Ch. Nandi road, P.O. Baharampur, Murshidabad	5	PVT	N.HOME	
201	Sushrusa Kendra (Maternity & Nursing Home)	23/8, Babulbona Road, P.O. & P.S.: Berhampur, Murshidabad	5	PVT	N.HOME	
202	New Dreamland Nursing Home	Islampore Hospital Road, Murshidabad	4	PVT	N.HOME	
203	K.G.N. Nursing Home	Vill.: Rambag More, P.O. & P.S.: Bhagabangola, Murshidabad	3	PVT	N.HOME	
204	Seva Chikitsalaya	Kandi, Murshidabad	3	PVT	N.HOME	
205	Beliview Nursing Home	Domkal, Murshidabad	2	PVT	N.HOME	
206	Jeeban Deep Nursing Home	Domkal, Murshidabad	2	PVT	N.HOME	
207	Rana View Nursing Home	Domkal, Murshidabad	2	PVT	N.HOME	
		TOTAL NUMBER OF BEDS IN MURSHIDABAD DISTRICT:	4161			
NADIA						
1	District Hospital – Nadia (Sadar Hospital Wing)	P.O. Krishnanagar, D.L. Roy Road, Nadia, Pin : 741101	495	GOVT	DH	
2	District Hospital – Nadia (Shaktinagar Wing)	Shaktinagar, Krishnanagar, Nadia	400	GOVT	DH	
3	S.D. Hospital – Ranaghat	P.O. & P.S. Ranaghat, Nadia	171	GOVT	SD	
4	Tehatta Sub Division Hospital	Tehatta – I, Nadia	15	GOVT	SD	
5	Santipur State General Hospital	P.O. Santipur, Nadia	131	GOVT	SG	
6	Nabadwip State General Hospital	Pratap Nagar, P.O. Nabadwip, Nadia	125	GOVT	SG	
7	Chakdah State General Hospital	P.O. Chakdah, Nadia	100	GOVT	SG	
8	Jawaharlal Nehru Memorial Hospital	P.O. Kalyani, Nadia	550	GOVT	SGH	
9	Gandhi Memorial Hospital	P.O. NSS, Kalyani, Nadia	350	GOVT	SGH	
10	Cooper's P.L. Home and Hospital	Ranaghat, P.O. Cooper's Camp, Nadia	30	GOVT	SGH	
11	Bethuadahari Rural Hospital	Nakashipara, P.O. Bethuadahari, Nadia	60	GOVT	RH	
12	Karimpur Rural Hospital	Karimpur – I, P.O. Karimpur, Nadia	50	GOVT	RH	
13	Bagula Rural Hospital	Hanskhali, P.O. Bagula, Nadia	30	GOVT	RH	
14	Chapra Rural Hospital,	Chapra, Nadia	25	GOVT	RH	
15	Haringhata Rural Hospital	Haringhata, P.O. Mohonpur, Nadia	25	GOVT	RH	
16	Kaliaganj Rural Hospital	Kaliaganj, P.O. Juranpur, Nadia	25	GOVT	RH	
17	Krishnaganj Rural Hospital	Krishnaganj, Nadia	25	GOVT	RH	
18	Aranghata BPHC	Ranaghat – 11, P.O. Aranghata, Nadia	15	GOVT	BPHC	
19	Dhubulia BPHC	Krishnanagar – II, P.O. Dhubulia, Nadia	15	GOVT	BPHC	
20	Habibpur (Jadav Dutta) BPHC	Ranaghat – 1, P.O. Habibpur, Nadia	15	GOVT	BPHC	
21	Maheshganj BPHC	Nabadwip, P.O. Maheshganj, Nadia	15	GOVT	BPHC	

DISTRICT WISE LIST OF BEDDED HCUs IN WEST BENGAL

INVENTORY: ANNEXURE - I

Sl. No	Name of the Units.	Address	Current Bed	Organisation	Category General	Category Special
22	Palashipara (Pritimoyee) BPHC	Tehatta – II, P.O. Palashipara, Nadia	15	GOVT	BPHC	
23	Bishnupur BPHC	Krishnanagar – I, P.O. Bishnupur, Nadia	10	GOVT	BPHC	
24	Nathidanga BPHC	Karimpur – II, P.O. Nathidanga, Nadia	10	GOVT	BPHC	
25	Panighata PHC	Kaliaganj, P.O. Paglachandi, Nadia	20	GOVT	PHC	
26	Arbandhi PHC	Santipur, P.O. Chandra, Nadia	10	GOVT	PHC	
27	Badkulla PHC	Hanskhali, P.O. Badkulla, Nadia	10	GOVT	PHC	
28	Baganchora PHC	Santipur, P.O. Baganchora, Nadia	10	GOVT	PHC	
29	Bagchi Jamsrpur PHC	Karimpur- I, P.O. Bagchi Jamserpur, Nadia	10	GOVT	PHC	
30	Dakshinpara PHC	Hanskhali, P.O. Chitrashali, Nadia	10	GOVT	PHC	
31	Debagram PHC	Kaliaganj, P.O. Debagram, Nadia	10	GOVT	PHC	
32	Dharamada PHC	Nakashipara, P.O. Dharmada, Nadia	10	GOVT	PHC	
33	Duttaphulia PHC	Ranaghat – II, P.O. Duttaphulia, Nadia	10	GOVT	PHC	
34	Gayeshpur PHC	Santipur, P.O. Gayeshpur, Nadia	10	GOVT	PHC	
35	Hridaypur PHC	Chapra, P.O. Suthia, Nadia	10	GOVT	PHC	
36	Juranpur PHC	Kaliaganj, P.O. Jurapur, Nadia	10	GOVT	PHC	
37	Mira PHC	Kaliaganj, P.O. Palashi, Nadia	10	GOVT	PHC	
38	Nabla (Fulia) PHC	Santipur, P.O. Fulia Colony, Nadia	10	GOVT	PHC	
39	Nakashipara (Dadpur) PHC	Nakashipara, P.O. Dadpur, Nadia	10	GOVT	PHC	
40	Noapara PHC	Krishnanagar – I, P.O. Rupadaha, Nadia	10	GOVT	PHC	
41	Sutargachi PHC	Chakdah, P.O. Simurali, Nadia	10	GOVT	PHC	
42	Syamnagar PHC	Tehatta – I, P.O. Shyamnagari, Nadia	10	GOVT	PHC	
43	Taherpur PHC	Ranaghat – 1, P.O. Taherpur, Nadia	10	GOVT	PHC	
44	Ashanagar PHC	Krishnanagar – I, P.O. Ashanagar, Nadia	6	GOVT	PHC	
45	Bagberia PHC	Chapra, P.O. Bagberia, Nadia	6	GOVT	PHC	
46	Barnia PHC	Tehatta – II, Barnia, Nadia	6	GOVT	PHC	
47	Belpukur PHC	Krishnanagar – I, P.O. Belpukur, Nadia	6	GOVT	PHC	
48	Bhajanghat PHC	Krishnanaganj, P.O. Bhajanghat, Nadia	6	GOVT	PHC	
49	Bhaluka PHC	Krishnanagar – I, P.O. Joania Bhaluka, Nadia	6	GOVT	PHC	
50	Birohi PHC	Haringhata, P.O. Birohi, Nadia	6	GOVT	PHC	
51	Chhota Nalda PHC	Tehatta – II, P.O. Chhota Nalda, Nadia	6	GOVT	PHC	
52	Gangsara PHC	Ranaghat – II, P.O. Belabazar, Nadia	6	GOVT	PHC	
53	Hanskhali PHC	Hanskhali, Nadia	6	GOVT	PHC	

DISTRICT WISE LIST OF BEDDED HCUs IN WEST BENGAL

INVENTORY: ANNEXURE - I

Sl. No	Name of the Units.	Address	Current Bed	Organisation	Category General	Category Special
54	Kastadanga PHC	Haringhata, P.O. Kastadanga, Nadia	6	GOVT	PHC	
55	Kusthia PHC	Tehatta – I, P.O. Kusthia, Nadia	6	GOVT	PHC	
56	Majhergram PHC	Nakashipara, P.O. Majhergram, Nadia	6	GOVT	PHC	
57	Matiary PHC	Kaliaganj, P.O. Matiary, Nadia	6	GOVT	PHC	
58	Moshra PHC	Chakdah, P.O. Moshra, Nadia	6	GOVT	PHC	
59	Nagarukhra PHC	Haringhata, P.O. Nagarukhra, Nadia	6	GOVT	PHC	
60	Nandanpur PHC	Karimpur – II, P.O. Gopalpur, Nadia	6	GOVT	PHC	
61	Paharpur PHC	Ranaghat-1, P.O. Kalinarayanpur, Nadia	6	GOVT	PHC	
62	Ramnagar PHC	Hanskhali, P.O. Ramnagar, Nadia	6	GOVT	PHC	
63	Shikarpur PHC	Karimpur – II, P.O. Sikarpur, Nadia	6	GOVT	PHC	
64	Sree Mayapur PHC	Nabadwip, P.O. Sree Mayapur, Nadia	6	GOVT	PHC	
65	Changhuri PHC	Nakashipara, P.O. Haranagar, Nadia	4	GOVT	PHC	
66	Chowgacha PHC	Chakdah, P.O. Chowgacha, Nadia	4	GOVT	PHC	
67	Gangnapur PHC	Ranaghat – II, P.O. Ganganapur, Nadia	4	GOVT	PHC	
68	Joyghata PHC	Krishnaganj, P.O. Joyghata, Nadia	4	GOVT	PHC	
69	Kamalpur PHC	Ranaghat – II, P.O. Purba Noapara, Nadia	4	GOVT	PHC	
70	Matiar (Banpur) PHC	Krishnaganj, P.O. Banpur, Nadia	4	GOVT	PHC	
71	Paschim Noapara Bhabasundari PHC	Ranaghat – 1, P.O. Noapara, Nadia	4	GOVT	PHC	
72	Srinagar PHC	Chakdah, P.O. Simurali, Nadia	4	GOVT	PHC	
73	Fakirdanga PHC	Nabadwip, P.O. Gholapara, Nadia	2	GOVT	PHC	
74	Gayeshpur Maternity & Clinic (IPP -VIII)	Gayeshpur, Nadia	20	GOVT	MUNI	MNTY
75	Dr. B.C. Roy Chest Sanatorium	Krishnanagar – II, P.O. Dhubulia, Nadia	1000	GOVT	TB	TB
76	Netaji Subhas Sanatorium	Gayeshpur, Nadia	803	GOVT	TB	TB
77	Krishnanagar Jail Hospital	Krishnanagar (M), P.O. Krishnanagar, Nadia	33	GOVT	SGJ	
78	E.S.I. Hospital – Kalyani	P.O. Kalyani, Nadia	250	GOVT	SGL	
79	Krishnanagar Police Hospital	Krishnanagar (M), P.O. Krishnagar, Nadia	46	GOVT	SGP	
80	B.S.F. Camp Hospital	Chapra, P.O. Seema Nagar, Nadia	10	GOVT	CG	
81	Susrusa Hospital & Medical Research Institute (P) Ltd.	Palpara More, P.O.: Bhatijangla, Krishnanagar, Nadia	105	PVT	N.HOME	
82	Mary Immaculate Hospital	Duck Banglo Road, Krishnanagar, P.S. - Kotwali, Nadia - 741 101	40	PVT	N.HOME	
83	Central Nursing Home,	26, B. L. Chatterjee Road, Krishnagar, Nadia.	32	PVT	N.HOME	
84	Majumder Millennium Nursing Home & Reliable Diagnostic P. Ltd.	A-3/12 (S), Kalyani, Nadia	31	PVT	N.HOME	
85	Nabadwip Nursing Home,	Dearapara, P.O. & P.S.: Nabadwip, Nadia.	30	PVT	N.HOME	

DISTRICT WISE LIST OF BEDDED HCUs IN WEST BENGAL

INVENTORY: ANNEXURE - I

Sl. No	Name of the Units.	Address	Current Bed	Organisation	Category General	Category Special
86	S.N.R. Carnival Maternity & Nursing Home,	A 9/16 (S), Kalyani, Nadia.	30	PVT	N.HOME	
87	Health Care Nursing Home,	B-7/46(S), Central Park, Kalyani, Nadia.	25	PVT	N.HOME	
88	Millenium Nursing Home & Reliable Diagnostic Cmter	A-9X/3 (C. A.), Kalyani, Nadia	25	PVT	N.HOME	
89	Self Reliance India (SRI Health Destination)	Tehatta, Nadia	25	PVT	N.HOME	
90	Apollo Nursing Home & Diagnostic Cneter	A-9X/6(C.A.), Kalyani, Nadia	20	PVT	N.HOME	
91	Astha Nursing Home	A - 9X / 4 (CA), P.O. & P.S.: Kalyani, Nadia	20	PVT	N.HOME	
92	Bhabani Nursing Home,	3, Subhas Avn. Ranaghat, Nadia.	20	PVT	N.HOME	
93	Central Nursing Home,	85/1, Rabindra Sarani, Ranaghat, Nadia	20	PVT	N.HOME	
94	Happy Soni Nursing Home	A-9/10(S), Kalyani, Nadia	20	PVT	N.HOME	
95	Mediview Clinic & Hospital	B-8/7 (CA), Kalyani, Nadia	20	PVT	N.HOME	
96	Shivalik Nursing Home	11/7, D.L. Roy Road, P.O. Krishnanagar, Nadia	20	PVT	N.HOME	
97	Sun View Maternity & Nursing Home,	73, P. K. Bhattacharia Road, Nediapara, Krishnagar, Nadia.	20	PVT	N.HOME	
98	Sunview Maternity & Nursing Home	73, P. K. Bhatteejee Road, Naderpara, P.O.: Krishnanagar, Nadia	20	PVT	N.HOME	
99	The Cure Nursing Home	A 9/14 (S), Kalyani, Nadia	20	PVT	N.HOME	
100	Mary Immaculate Hospital	Chapra, P.O.: Bangaljihi, Nadia	18	PVT	N.HOME	
101	Anjali Arogya Niketan	28, Kurchipota Lane, Krishnanagar, Nadia	15	PVT	N.HOME	
102	Avenue Nursing Home,	58, Subhas Avn. Ranaghat, Nadia	15	PVT	N.HOME	
103	Charubala Nursing Home	B-12/33(S), Kalyani, Nadia.	15	PVT	N.HOME	
104	Life Nursing Home,	67, Subhas Avn, Ranaghat, Nadia.	15	PVT	N.HOME	
105	Nabadeepalok Nursing Home	37/1, Ramsita Para Road, Ramsita Para, P.O. & P.S.: Nabadwip, Nadia	15	PVT	N.HOME	
106	Nadia Maternity & Nursing Home	37, Kurchipota lane, Krishnagar Nadia	15	PVT	N.HOME	
107	Well Care Nursing Home	B-9/279(C.A.), Kalyani, Nadia	15	PVT	N.HOME	
108	Ambedkar Eye General Health Relief Center	Nazirpur, Nadia	10	PVT	N.HOME	EYE
109	Vision (Nabadwip Lions Hospital)	Bow Bazar Road, Motiganj Bandh, Nabadwip, Nadia	10	PVT	N.HOME	EYE
110	Carnival Hospital	A-9/16 (S) & A-9/17 (S), Kalyani, Nadia	10	PVT	N.HOME	
111	Central Nursing Home,	B-9/26(C.A.), Kalyani, Nadia.	10	PVT	N.HOME	
112	Diamond Nursing Home	Ranaghat, Nadia	10	PVT	N.HOME	
113	Dr. B.R. Ambedkar Eye & General Health Relief Centre	P.O.: Nazipur, P.S.: Tehatta, Nadia	10	PVT	N.HOME	
114	Dreamland Nursing Home	19, S. V. Sarani, Rajbaganpara, P.O.: Ranaghat, Nadia	10	PVT	N.HOME	
115	Lake View Nursing Home	30, M.M. Ghosh Street, P.O.: Krishnanagar, P.S.: Kotwali, Nadia	10	PVT	N.HOME	
116	Life Care Nursing Home	B-9/23(C.A.), Kalyani, Nadia	10	PVT	N.HOME	
117	Nilmani Seva Sadan	Santipur, Nadia	10	PVT	N.HOME	

DISTRICT WISE LIST OF BEDDED HCUs IN WEST BENGAL

INVENTORY: ANNEXURE - I

Sl. No	Name of the Units.	Address	Current Bed	Organisation	Category General	Category Special
118	Orient Nursing Home & Poly Clinic,	Natunbazar, Krishnagar, Nadia.	10	PVT	N.HOME	
119	Pitri Smriti Nursing Home	Karimpur, Nadia	10	PVT	N.HOME	
120	Radharani Seba Sadan	Shyam Babu Ghat Lane, Ranaghat, Nadia	10	PVT	N.HOME	
121	Rameswar Maternity Clinic & Child Welfare Center	Munshipara Street, Santipur, Nadia	10	PVT	N.HOME	
122	Sanjiban Nursing Home & Diagnostic Center	Bagula, Nadia	10	PVT	N.HOME	
123	Seba Niketan Nursing Home,	33, Benepara, P.O. & P.S.: Nabadwip, Nadia.	10	PVT	N.HOME	
124	Sevayan Nursing Home	Ramsitapara, Krishnagar, Nadia	10	PVT	N.HOME	
125	Sonali Nursing Home	Bara Anulia, Nadia	10	PVT	N.HOME	
126	Sumativilla Nursing Home	Nabadwip, Nadia	10	PVT	N.HOME	
127	Sumativilla Prasabagar,	Bangapara, Nabadwip, Nadia	10	PVT	N.HOME	
128	Sushrusa Nursing Home	P.W.D. Para, P.O.& P.S.: Tehatta, Nadia	10	PVT	N.HOME	
129	Suwendu Memorial Seva Pratisthan	69/12, Bidhubhushan Sengupta Road, Gobrapota, Kotwali, Nadia	10	PVT	N.HOME	
130	Swasti Medical Care & Leproscopy Unit	Ranaghat, Nadia	10	PVT	N.HOME	
131	The City Maternity & Nursing Home	Krishnagar, Nadia.	10	PVT	N.HOME	
132	The paradise Nursing Home	Patra Bazar, Nadia	10	PVT	N.HOME	
133	Ula Maternity Home & Hospital	Birnagar, Nadia	10	PVT	N.HOME	
134	Kalyani Nursing Home	B-8/37(C.A.), Kalyani, Nadia	8	PVT	N.HOME	
135	Mahindra Maternity Nursing Home	Krishnanagar, Nadia	8	PVT	N.HOME	
136	Charu matri Sadan (M.T.P. Center)	Chakdah, Nadia (Near Chakdah Rail Station)	7	PVT	N.HOME	
137	Sri Krishna Seva Sadan (M.T.P. Centera)	N. S, Road, Chakdah	7	PVT	N.HOME	
138	Chapra Seva Sadan Nursing Home	Srinagar, P.O.: Bangaljhi, Nadia	6	PVT	N.HOME	
139	Sumatibala Prasabagar	Nabadwip, Nadia	6	PVT	N.HOME	
140	Eye Care Center	Payaradanga, P.O.: Pritinagar, Nadia	5	PVT	N.HOME	EYE
141	Lions Club Of Ranaghat - West (Eye Hospital)	Biswas Para Lane, Ranaghat	5	PVT	N.HOME	EYE
142	Mordern Eye Care Nursing Home	E-4/18, Kalyani, Nadia	5	PVT	N.HOME	EYE
143	Netra Jyoti Eye Institute	9/1, Subhas Avenue, Ranaghat, Nadia	5	PVT	N.HOME	EYE
144	Ranaghat Lions Eye Hospital	Ranaghat, Nadia	5	PVT	N.HOME	EYE
145	Samanta Eye Clinic & Nursing Home	1/6, College Street, Krishnanagar, Nadia	5	PVT	N.HOME	EYE
146	Angel Nursing Home	Bethuadahari, Nadia	5	PVT	N.HOME	
147	Bagchi Clinic (Maternity)	Subuddhipr, P.O.: Madhabpur, P.S.: Haringhata, Nadia	5	PVT	N.HOME	
148	India Nursing Home	Chapra, P.O. Suthia, Nadia	5	PVT	N.HOME	
Sl. No	Name of the Units.	Address	Current Bed	Organisation	Category General	Category Special

DISTRICT WISE LIST OF BEDDED HCUs IN WEST BENGAL

INVENTORY: ANNEXURE - I

149	Kaya Kalpa Sadan Nursing Home,	9/1A, Pandit L. K. Maitra Road, Krishnagar, Nadia.	5	PVT	N.HOME	
150	Loknath Polyclinic & Nursing Home	Ranaghat, Nadia	5	PVT	N.HOME	
151	Majumder Nursing Home	A-11/172, Kalyani, Nadia	5	PVT	N.HOME	
152	Nabajiban Nursing Home	Debgram , Kaliganj, Nadia.	5	PVT	N.HOME	
153	National Nursing Home	Mira Kaliganj More, P.O.: Palassy, Nadia	5	PVT	N.HOME	
154	New Mahindra Maternity & Nursing Home	8/1, R. K. Mitra Lane, Patra Bazar, Krishnanagar, Nadia	5	PVT	N.HOME	
155	Ranaghat Nursing Home,	39, Subhas Avn. Ranaghat, Nadia.	5	PVT	N.HOME	
156	Seva Sadan Nursing Home,	Debgram, Katwa More, Kaliganj, Nadia.	5	PVT	N.HOME	
157	Sri Guru Sangha Nursing Home	Sri Guru Sangha Lane, Ranichara, Nabadwip, Nadia	5	PVT	N.HOME	
158	Vivekananda Seva Sadan	Gangnapur, Ranaghat, Nadia	5	PVT	N.HOME	
159	Welcome Nursing Home	P.O. Kalyani, Nadia	5	PVT	N.HOME	
160	Anju Eye Nursing Home,	66/4, Pal Chowdhury Street, Ranaghat, Nadia.	4	PVT	N.HOME	EYE
161	Dr. B. C. Roy Eye Foundation	Kalyani, Nadia	4	PVT	N.HOME	EYE
162	Elite Eye Care & Microsurgery Centre,	A-9X/4(S), Kalyani, Nadia.	4	PVT	N.HOME	EYE
163	Janani Eye Care & Research Center	73/3, K. C. Das Road, P.O. & P.S. : Santipur, Nadia	4	PVT	N.HOME	EYE
164	Modern Eye Care & Micro Surgery Nursing Home,	B-12/33(S), Kalyani, Nadia.	3	PVT	N.HOME	EYE
165	Devine Nursing Home	P.O. Ranaghat, Nadia	3	PVT	N.HOME	
166	Sri Aurobinda Youth Organisation	Kalinarayanpur, Nadia	3	PVT	N.HOME	
167	Narayan Clinic	S. P. Mukherjee Road, Chakdah	2	PVT	N.HOME	
168	Dillons Hospital - Chakdah	NH-34, Tantgachi More, P.O. Routari, Vill. Routari, Chakdah, Dist. Nadia,	200	PVT	Pvt Hsptl	
		TOTAL NUMBER OF BEDS IN NADIA DISTRICT:	6519			
NORTH 24 PARGANAS						
1	District Hospital – Barasat,	P.O. Barasast, 24, Parganas (N)	500	GOVT	DH	
2	Dr. Jiban Ratan Dhar S.D. Hospital	P.O. Bongaon, 24 Parganas (N)	250	GOVT	SD	
3	S.D. Hospital – Basirhat	P.O. Basirhat, 24 Parganas (N)	200	GOVT	SD	
4	Dr. B.N. Bose S.D. Hospital	P.O. Barrackpore, 24 Parganas (N)	200	GOVT	SD	
5	S.D. Hospital – Salt Lake	DD-36, Sec-I, Salt Lake, Kol - 64	100	GOVT	SD	
6	Panihati State General Hospital	P.O. Sodepur, 24 Parganas (N)	150	GOVT	SG	
7	Habra State General Hospital	P.O. Habra, 24 Parganas (N)	131	GOVT	SG	
8	Naihati State General Hospital	P.O. Naihati, 24 Parganas (N)	131	GOVT	SG	
9	Sagar Dutta State General Hospital	9, B. T. Road, P.O. Kamarhati, 24 Parganas (N)	131	GOVT	SG	
10	Bhatpara State General Hospital	P.O. Bhatpara, 24 Parganas (N)	119	GOVT	SG	

DISTRICT WISE LIST OF BEDDED HCUs IN WEST BENGAL

INVENTORY: ANNEXURE - I

Sl. No	Name of the Units.	Address	Current Bed	Organisation	Category General	Category Special
11	Baranagar State General Hospital	104, A.K. Mukherjee Road, P.O. Baranagar, Kolkata-700090	100	GOVT	SG	
12	Sree Balaram Seva Mandir Hospital	M. S. Mukherjee Road, P.O. Khardaha, 24 Parganas (N)	100	GOVT	SG	
13	Ashoknagar State General Hospital	P.O. Ashoknagar, 24 Parganas (N)	50	GOVT	SG	
14	National Institute of Homoeopathy	Block – GE, Sector – III, Salt Lake, Kolkata - 106	60	GOVT	SGH	
15	Jyangra M.C.H. Care Hospital	Rajarhat, Baguihati, 24 Pgns (N)	2	GOVT	SGH	
16	Rudrapur (Baduria) Rural Hospital	P.O. Rudrapur, 24 Parganas (N)	60	GOVT	RH	
17	Taki Rural Hospital	P.O. Taki, 24 Parganas (N)	50	GOVT	RH	
18	Bagda Rural Hospital	P.O. Bagda, 24 Parganas (N)	30	GOVT	RH	
19	Gobardanga Gramin Hospital	Habra, P.O. Gobardanga, 24 Pgns (N)	30	GOVT	RH	
20	Madhyamgram Rural Hospital	P.O. Madhyamgram, 24 Parganas (N)	30	GOVT	RH	
21	Minakhan Rural Hospital	P.O. Minakhan, 24 Parganas (N)	25	GOVT	RH	
22	Sandeshkhali Rural Hosital	P.O. Sandeshkhali, 24 Parganas (N)	25	GOVT	RH	
23	Sarapole (Sonarpur) Rural Hospital	P.O. Sarapole, Swarnapnagar 24 Parganas (N)	15	GOVT	RH	
24	Amdanga BPHC	Amdanga, 24 Pgns (N)	15	GOVT	BPHC	
25	Bandipur BPHC	Barrackpore, P.O. Bandipur, 24 Pgns (N)	15	GOVT	BPHC	
26	Biswanathpur BPHC	Deganga, P.O.Deganga, 24 Pgns (N)	15	GOVT	BPHC	
27	Chandpara BPHC	Gaighata, P.O. Thakurnagar, 24 Pgns (N)	15	GOVT	BPHC	
28	Chhota Jagulia BPHC	Barasat, P.O. Chhota Jagulia, 24 Pgns (N)	15	GOVT	BPHC	
29	Dhanyakuria BPHC	Basirhat, P.O. Dhanyakuria, 24 Pgns (N)	15	GOVT	BPHC	
30	Ghoshpur BPHC	P.O. Ghoshpur, 24 Parganas (N)	15	GOVT	BPHC	
31	Haroa (Adampur) BPHC	Haroa, P.O. Haroa, 24 Pgns (N)	15	GOVT	BPHC	
32	Rekjoani BPHC	Rajarhat, 24 Pgns (N)	15	GOVT	BPHC	
33	Sabdapur BPHC	Habra, P.O. Sabdalpur, 24 Pgns (N)	15	GOVT	BPHC	
34	Sandelerbil BPHC	Hingalganj, Sandelerbil, 24 Pgns (N)	15	GOVT	BPHC	
35	Shibhati BPHC	Basirhat, P.O. Shibhati, 24 Pgns (N)	15	GOVT	BPHC	
36	Maslandapur BPHC	Habra, P.O. Maslandapur, 24 Pgns (N)	10	GOVT	BPHC	
37	Nanna BPHC	Barrackpore., P.O. Malancha Via Hazinagar, 24 Pgns (N)	8	GOVT	BPHC	
38	Sundarpur BPHC	Bongaon, P.O. Palla, 24 Pgns (N)	6	GOVT	BPHC	
39	Bajitpur (Belghoria) PHC	Baduria, P.O. Model Belgharia, 24 Pgns (N)	10	GOVT	PHC	
40	Bankra PHC	Swarnapnagar, P.O. Bankra, 24 Pgns (N)	10	GOVT	PHC	
41	Bhawanipur PHC	Hasnabad, P.O. Bhurkundu, 24 Pgns (N)	10	GOVT	PHC	
42	Chandpur (Arbelia) PHC	Rajarhat, P.O. Badu, 24 Pgns (N)	10	GOVT	PHC	

DISTRICT WISE LIST OF BEDDED HCUs IN WEST BENGAL

INVENTORY: ANNEXURE - I

Sl. No	Name of the Units.	Address	Current Bed	Organisation	Category General	Category Special
43	Dhuturdaha PHC	Minakhan, P.O. Dhuturdaha, 24 Pgns (N)	10	GOVT	PHC	
44	Kadambagachi PHC	Barasat, P.O. Kadambagachi, 24 Pgns (N)	10	GOVT	PHC	
45	Kolsur PHC	Deganga, P.O. Deganga, 24 Pgns (N)	10	GOVT	PHC	
46	Marich PHC	Amdanga, P.O. Masunda, 24 Pgns (N)	10	GOVT	PHC	
47	Sindrani PHC	Bagda, P.O. Sindrani, 24 Pgns (N)	10	GOVT	PHC	
48	Adhata – Joypur PHC	Amdanga, P.O. Adhata, 24 Pgns (N)	6	GOVT	PHC	
49	Baduria PHC	Gaighata, P.O. Ramchandrapur, 24 Pgns (N)	6	GOVT	PHC	
50	Bagband Siberia (Kemia Kamarpara) PHC	Barasat, P.O. Kirtipur, 24 Pgns (N)	6	GOVT	PHC	
51	Baraberia PHC	Amdanga, P.O. Baraberia, 24 Pgns (N)	6	GOVT	PHC	
52	Bilkanda (Tegharia) PHC	Barrackpore, P.O. Jugberia, 24 Pgns (N)	6	GOVT	PHC	
53	Charghat PHC	Swarupnagar, P.O. Charghat, 24 Pgns (N)	6	GOVT	PHC	
54	Dakshin Chatra PHC	Baduria, P.O. Dakshin Chatra, 24 Pgns (N)	6	GOVT	PHC	
55	Dharampur PHC	Gaighata, P.O. Dharampur, 24 Pgns (N)	6	GOVT	PHC	
56	Dr. D.R. Roy (Ghonja) PHC	Gaighata, P.O. Ghonja, 24 Pgns (N)	6	GOVT	PHC	
57	Duttapukur PHC	Barasat, P.O. Duttapukur, 24 Pgns (N)	6	GOVT	PHC	
58	Ghola (Bhebia) PHC	Hasnabad, P.O. Bhebia, 24 Pgns (N)	6	GOVT	PHC	
59	Gopalpur PHC	Haroa, P.O. Gopalpur, 24 Pgns (N)	6	GOVT	PHC	
60	Hatgachia PHC	Sandeshkhali, P.O. Agarbati, 24 Pgns (N)	6	GOVT	PHC	
61	Jadurhati PHC	Baduria, P.O. Jadurhati, 24 Pgns (N)	6	GOVT	PHC	
62	Kamarghanti PHC	Haroa, P.O. Sonapukur, 24 Pgns (N)	6	GOVT	PHC	
63	Koniera PHC	Bagda, P.O. Bena, 24 Pgns (N)	6	GOVT	PHC	
64	Korakanthi PHC	Sandeshkhali, P.O. Korakanthi, 24 Pgns (N)	6	GOVT	PHC	
65	Masia PHC	Baduria, P.O. Masia, 24 Pgns (N)	6	GOVT	PHC	
66	Mitpukuria PHC	Barasat, P.O. Sashan, 24 Pgns (N)	6	GOVT	PHC	
67	Nakuda PHC	Basirhat, P.O. Nakuda, 24 Pgns (N)	6	GOVT	PHC	
68	Narayanpur PHC	Barrackpore, P.O. Kankinara via Jagatdal, 24 Pgns (N)	6	GOVT	PHC	
69	Nataberia PHC	Bagda, P.O. Mangalganj, 24 Pgns (N)	6	GOVT	PHC	
70	Nimichi PHC	Minakhan, P.O. Minakhan, 24 Pgns (N)	6	GOVT	PHC	
71	Pakurkona PHC	Habra, P.O. Bira Ballabhpara, 24 Pgns (N)	6	GOVT	PHC	
72	Rajendrapur PHC	Rajendrapur, North 24 Pgs.	6	GOVT	PHC	
73	Routara PHC	Habra, P.O. Routara, 24 Pgns (N)	6	GOVT	PHC	
74	Sahebkhali (Duldali) PHC	Hingalganj, P.O. Sahebkhali, 24 Pgns (N)	6	GOVT	PHC	

DISTRICT WISE LIST OF BEDDED HCUs IN WEST BENGAL

INVENTORY: ANNEXURE - I

Sl. No	Name of the Units.	Address	Current Bed	Organisation	Category General	Category Special
75	Akaipur PHC	Bongaon, P.O. Garibpur, 24 Pgns (N)	4	GOVT	PHC	
76	Chowberia PHC	Bongaon, P.O. Chowberia, 24 Pgns (N)	4	GOVT	PHC	
77	Gaighata PHC	Gaighata, P.O. Gaighata, 24 Pgns (N)	4	GOVT	PHC	
78	Hadipur – Jhikra PHC	Deganga, P.O. Ajijnagar, 24 Pgns (N)	4	GOVT	PHC	
79	Kartikpur PHC	Deganga, P.O. Kartikpur, 24 Pgns (N)	4	GOVT	PHC	
80	Palla PHC	Bongaon, P.O. Palla, 24 Pgns (N)	4	GOVT	PHC	
81	Patharghata PHC	Rajarhat, P.O. Patharghata, 24 Pgns (N)	4	GOVT	PHC	
82	Raypur Chakla PHC	Deganga, P.O. Chakla, 24 Pgns (N)	4	GOVT	PHC	
83	Sikra Kulingram PHC	Basirhat, P.O. Sikra Kulingram, 24 Pgns (N)	4	GOVT	PHC	
84	Barunhat PHC	Hasnabad, P.O. Bara Bankra, 24 Pgns (N)	2	GOVT	PHC	
85	Hingalganj PHC	Hingalganj, 24 Pgns (N)	2	GOVT	PHC	
86	Jeliakhali PHC	Sandeshkhali, P.O. Jeliakhali, 24 Pgns (N)	2	GOVT	PHC	
87	Jogeshganj PHC	Hingalganj, P.O. Jogeshganj, 24 Pgns (N)	2	GOVT	PHC	
88	Nazat PHC	Sandeshkhali, P.O. Nazat, 24 Pgns (N)	2	GOVT	PHC	
89	Pumlia PHC	Habra, P.O. Sendanga, 24 Pgns (N)	2	GOVT	PHC	
90	Sultanpur PHC	Barrackpur, P.O. Sultanpur, 24 Pgns (N)	2	GOVT	PHC	
91	Dum Dum Municipal Specialised Hospital	Dum Dum, 24 Pgns (N)	128	GOVT	MUNI	
92	Netaji Subhas Ch. Bose Specialised Hospital & Res Center	Basunagar, Harmogvila, Madhyamgram	60	GOVT	MUNI	
93	North Barrackpore Municipal J.B.M. Maternity & General Hospital	Kanthadhar, Ichhapore, 24 Parganas (N)	50	GOVT	MUNI	GEN
94	North Dum Dum Municipal Hospital	North Dum Dum, 24 Pgns (N)	40	GOVT	MUNI	GEN
95	Baranagar Maternity Hospital	Baranagar, 24 Pgns (N)	40	GOVT	MUNI	MNTY
96	Matri Sadan (Maternity Home)	Deshbandhu Nagar, Baranagar, Kolkata – 59	40	GOVT	MUNI	MNTY
97	Prajanandan Saraswati Seva Sadan	Ashoknagar, North 24 Pgs	25	GOVT	MUNI	GEN
98	Panihati Municipal Maternity Home	Barasat Road, Ghola, North 24 Pgs	25	GOVT	MUNI	MNTY
99	South Dum Dum Municipal Hospital	Nager Bazar	20	GOVT	MUNI	GEN
100	Bhatpara Maternity (Bhatpara Municipality)	Kankinara, 24 Parganas (North)	20	GOVT	MUNI	MNTY
101	Maternity Home (Naihati Municipality)	1, R. B. C. Road, Naihati, 24 Pgs (n)	20	GOVT	MUNI	MNTY
102	Vidyasagar Matri Sadan	Sri Ramesh Mitra Road, Narayanpur, Gopalpur	20	GOVT	MUNI	MNTY
103	Matri Sadan Bidhannagar Municipality Hospital	Bidhannagar(E), Ultadanga, W-15, Kolkata- 700091	20	GOVT	MUNI	MNTY
104	Matri Mangal Pratisthan	Bhatpara, 24 Pgns (N)	15	GOVT	MUNI	
105	Maternity Hospital,(Titagarh Municipality)	B. T. Road, Titagarh, North 24 Pgs	12	GOVT	MUNI	
106	Lalit Mohan Maternity Home	Naihati, 24 Pgns (N)	11	GOVT	MUNI	

DISTRICT WISE LIST OF BEDDED HCUs IN WEST BENGAL

INVENTORY: ANNEXURE - I

Sl. No	Name of the Units.	Address	Current Bed	Organisation	Category General	Category Special
107	Maternity Home (Bidhannagar Municipality)	EE-55/A, Sec-II, Salt Lake,	10	GOVT	MUNI	
108	Shibani Arogya Niketan	Kanchrapara, 24 Pgns (N)	8	GOVT	MUNI	
109	Basirhat Matri Sadan (Municipal)	Moila Khola, Basirhat.	6	GOVT	MUNI	
110	Halisahar Maternity & Child Welfare Center	Halisahar, 24 Pgns (N)	5	GOVT	MUNI	
111	Hasnabad Matri Sadan (Taki Municipality)	Hasnabad Puratan Bazar, Taki, 24 Pgs (N)	5	GOVT	MUNI	
112	National Institute for the Orthopedically Handicapped	B. T. Road, Bon-Hooghly, Kol - 90	45	GOVT	CG	
113	Ordnance Factories Hospital	P.O.: Ishapore, Nawabganj, North 24 Parganas	125	GOVT	DEF	
114	Cantonment General Hospital Barrackpore	Barrackpore, 24 Pgns (N)	48	GOVT	DEF	
115	Ordnance Factory Hospital, Dum Dum	Dum Dum, Kolkata	12	GOVT	DEF	
116	Kanchrapara Rly. Hospital	Kanchrapara, 24 Pgns (N)	220	GOVT	RLY	
117	Bongaon Rly. Hospital	Bongaon, 24 Pgns (N)	4	GOVT	RLY	
118	Dum Dum Central Jail Hospital	Dum Dum, 24 Pgns (N)	100	GOVT	SGJ	
119	District Jail Hospital	Barasat, 24, Pgns (N)	15	GOVT	SGJ	
120	E.S.I. Hospital – Kamarhati	1, Graham Road, P.O. Kamarhati, 24 Parganas (N)	325	GOVT	SGL	
121	Brigade Police Hospital, Barrackpore	Barrackpore, 24 Pgns (N)	120	GOVT	SGP	
122	Male Vagrant's Home (Petrapole)	Bongaon, 24 Pgns (N)	10	GOVT	SGV	
123	Patipukur T.B. Hospital	26, S.K. Dev Road, Calcutta - 48	94	GOVT	TB	TB
124	Aditya Health Research Foundation (P) Ltd.	Koyra, Kadambagachi, Barasat, North 24 Parganas	200	PVT	N.HOME	
125	Susrata Clinic & Research Institute for Advanced Medicine Pvt.Ltd.	JC-16&17, Salt Lake, Kol - 98	180	PVT	N.HOME	
126	Gandhiji Prem Nivas Leprosy Center (Missionaries of Charity)	Titagarh, 24 Pgs (N)	173	PVT	N.HOME	LEPR
127	Anandalok Hospital	DK – 7/3, Salt Lake, Sector – II, Kolkata - 91	151	PVT	N.HOME	
128	Tata Medical Centre Trust	Plot No.: DH - 7 & DH - 8, Premises No.: 14MAR(E-W), New Town ,	150	PVT	N.HOME	
129	Daffodil Nursing Home Pvt. Ltd.,	276, Canal Street, Kolkata - 48	100	PVT	N.HOME	
130	Restorative Clinic & Research Centre Pvt. Ltd.	Station Road, Sodepur, 24 Parganas (North)	100	PVT	N.HOME	
131	Navketan Nursing Home PVT. Ltd.	IB-193, Sec - III, Salt Lake, Kolkata - 91	90	PVT	N.HOME	
132	Rotary Narayan Sankar Netralaya	CN-5, Sec - V, Saltlake City, Kol - 91	75	PVT	N.HOME	
133	ILS Multispeciality Clinic	Jeevasatya, DD-6, Sector-I, Salt Lake City, Kol - 64	63	PVT	N.HOME	
134	Disha Eye Hospital & Research Centre	99/1, S.N. Banerjee Road, Barrackpore, 24 Pgns (N)	60	PVT	N.HOME	EYE
135	Charnok Hospital & Research Center (P) Ltd.	Megacity Approach Road, P.O.: Hatiara, Teghoria, P.S.: Rajarhat, Kol - 59	60	PVT	N.HOME	
136	Paschim Banga Samaj Seva Samity Hospital	28/2, Masjid Bari Lane, Kolkata - 36	60	PVT	N.HOME	
137	Uma Medical Related Institute Pvt. Ltd.,	Tegharia Dhalipara, VIP Road, Calcutta – 59	60	PVT	N.HOME	

DISTRICT WISE LIST OF BEDDED HCUs IN WEST BENGAL

INVENTORY: ANNEXURE - I

Sl. No	Name of the Units.	Address	Current Bed	Organisation	Category General	Category Special
138	VIP Apex Medi & Research Centre Pvt. Ltd.,	H/1-16, Sachindralal Sarani, Baguihati, Kolkata – 59,	60	PVT	N.HOME	
139	Calcutta Heart Clinic & Hospital	HC Block, Salt lake City, Sec - III, Kol - 106	52	PVT	N.HOME	
140	Kalpataru Arogya Niketan O Gabesana Pratisthan (Hospital)	Ramkrishnapally, Taki Road,P.O. & P.S. Barasat, 24 Pgns (N)	52	PVT	N.HOME	
141	Ramkrishna Mission Boys Home	P.O. Rahara, 24 Pgns (N)	52	PVT	N.HOME	
142	Binayak Multi Speciality Hospital	59, Kalicharan Ghosh Road, Kolkata - 50, North 24 Parganas	51	PVT	N.HOME	
143	Aditya Hospital (Unit of AHRF Pvt. Ltd.)	965, Jesspre Road, Kol - 55	50	PVT	N.HOME	
144	Dr. B.C. Roy General Hospital & Maternity Home	B. C. Roy Sarani, New Barrackpore, Noth 24 Pgs.	50	PVT	N.HOME	
145	Metropolitan Homeopathy Medical Collage & Hospital	Ramchandrapur, P.O.: Sodepur, 24 Pgs (N)	50	PVT	N.HOME	
146	New Barrackpore General Hospital (Dr. B.C. Roy Hospital)	P.O. New Barrackpore, 24 Parganas (N)	50	PVT	N.HOME	
147	Tahiria Hospital (Taheria Wlfare Trust)	Haroa, North 24 Pgs.	50	PVT	N.HOME	
148	Eco Hospital & Diagnostic (Econo Medical Pvt. Ltd.)	111/1, Jessore Road, Barasat, 24 Parganas (North)	40	PVT	N.HOME	
149	Jaytishman Multi Disciplinary Hospital (P) Ltd.	P.O.: Belghoria, Kol - 56, North 24 Parganas	40	PVT	N.HOME	
150	Little Heart Nirikshan Kendra	1, Kaikhali Road, P.O. R. Gopalpur, Kol - 700 136	40	PVT	N.HOME	
151	Midland Nursing Home (P) Ltd.,	33, Anupama Road, Kol - 56	40	PVT	N.HOME	
152	Ram Krishna Matri Mongal Pratisthan (Charitable)	112, Feeder Road, Kolkata - 57	40	PVT	N.HOME	
153	Spandan Nursing Home Pvt. Ltd.	Kalibari Complex, Rajarhat, 24 Parganas (N)	40	PVT	N.HOME	
154	Netaji Sevayan Hospital	Nilgunge Road, P.O. Agarpara, 24 Parganas (N)	35	PVT	N.HOME	
155	Ashirbad Nursing Home & Diagnostic Center	BD-53, Rabindrapally, Krishnapur, Kol - 101	33	PVT	N.HOME	
156	Institute of Laparoscopic Surgery,	Jiban Satya, DD – 16, Salt Lake City, Sector – I, Kolkata -64	32	PVT	N.HOME	
157	Seba Co operative Health Society Ltd.	DD-35, Salt Lake, Kol - 64	31	PVT	N.HOME	
158	Bhattacharjee Orthopedics & related Research Centre	Narayanpur, R/Gopalpur, 24 pgns (N)	30	PVT	N.HOME	
159	Critical & Trauma Care Hospital & Nursing Home	177, B.T. Road, Calcutta – 35, 24 Parganas (N)	30	PVT	N.HOME	
160	Jeeva Nursing Home (P) Ltd.	Najrul Islam Avenue, Tegharia, P.O.: Hatiara, Kol - 59	30	PVT	N.HOME	
161	Lahiri Clinic & Maternity Home	60/2, Rabartson Road, P.O. & P.S.: Naihati, 24 Pgns (N)	30	PVT	N.HOME	
162	New Life orthopedic & Sports Medicine Res. Center	Sahabagan, Rajarhat Road, Opp. Arati Cinema, Kol - 59	30	PVT	N.HOME	
163	Sahid Khudiram Bose Institute & Research Center	B. T. Road, Belghoria, Kol - 56	30	PVT	N.HOME	
164	Tulip Nursing Home (P) Ltd.	96, Rishi Bankim Chandra Road, Kol - 28	30	PVT	N.HOME	
165	Usti Foundation India	5, Dakshindari Hospital, Nehru Colony, Kolkata -	30	PVT	N.HOME	
166	Western View Nursing Home	Charaktala, P.O. Bongaon, 24 Parganas (North)	30	PVT	N.HOME	
167	North Point Nursing Home Pvt. Ltd.,	39, Post Office Road, Calcutta – 28	29	PVT	N.HOME	
168	Anandalok	P.O. & P.S.: Baduria, North 24 Parganas	26	PVT	N.HOME	
169	Prallhad Memorial (Nursing Home) Seva Sadan	1, Kumud Ghosal Road, Aridaha, Kolkata - 57	26	PVT	N.HOME	

DISTRICT WISE LIST OF BEDDED HCUs IN WEST BENGAL

INVENTORY: ANNEXURE - I

Sl. No	Name of the Units.	Address	Current Bed	Organisation	Category General	Category Special
170	Susrut Eye Foundation & Research Centre	HB-36/1, Sector – III, Salt Lake, Calcutta - 91	25	PVT	N.HOME	EYE
171	Bliss Nursing Home	B-1, Rajarhat Road, Baguihati, Kolkata – 59	25	PVT	N.HOME	
172	Dum Dum Medical Center	3A, Polock Avenue, Kolkata – 55, North 24 Pgs.	25	PVT	N.HOME	
173	Lilabati Nursing Home	Taltala, Rajarhat, Kolkata - 59	25	PVT	N.HOME	
174	M.P. Clinic	Lake Town, 37, Bangur Avenue, Calcutta - 55	25	PVT	N.HOME	
175	Megacity Nursing Home	12, Jessore Road, Barasat, 24 Pgns (N)	25	PVT	N.HOME	
176	Nirama Nursing & Poly Clinic	101/5, Jessore Road, Habra, 24 Pgns (N)	25	PVT	N.HOME	
177	Sukalyan Nursing Home	VIP Road, Raghunathpur, Deshbandhunagar, North 24 Parganas	25	PVT	N.HOME	
178	Barasat Cancer Research & Welfare Centre	Banamalipur, P.O. Barasat, 24 Pgns (N)	20	PVT	N.HOME	CAN
179	Nehru Cancer Centre for Research & Care	6, Barasat Road, Barrackpore, 24 Pgns (N)	20	PVT	N.HOME	CAN
180	Barrackpore Medicare & Recovery Centre Ltd.	6/6, B.T. Road, P.O. Talpukur, Titagarh, 24 Pgns (N)	20	PVT	N.HOME	
181	Care & Cure Nursing Home	Surendranath Colony, Nabapally Barasat, North 24 Parganas	20	PVT	N.HOME	
182	Dafodil Nursing Home & Polyclinic	97, Jessor Road, Udayrajpur (East), Madhyagram, North 24 Parganas	20	PVT	N.HOME	
183	Dream Land Nursing Home	Chakdah Road, Bongaon, 24 Pgns (N)	20	PVT	N.HOME	
184	Dulali Children's Hospital	Gaipur, P.O. Gobardanga, 24 Parganas (N)	20	PVT	N.HOME	
185	Gurunanak Trust of Dental Seva Research	157/F, Nilgunj Road, Panihati, North 24 Pgs	20	PVT	N.HOME	
186	Madhab Medical Complex Nursing Home	Chakdah Road, Bongaon, North 24 Parganas	20	PVT	N.HOME	
187	New Sebayan Nursing Home	66/2, Vivekananda Road, Nibedita Place, Taki Road, Barasat, N 24 Pgs	20	PVT	N.HOME	
188	Panacia Nursing Home	32/8, Barasat Road, 15 No. Rail Gate P.O: Nonachandanpukur, Ps: Titagarh	20	PVT	N.HOME	
189	Phoenix Hospital & Research Centre,	2, Motilal Colony, Nirmal Sengupta Sarani, Cal- 81	20	PVT	N.HOME	
190	Prafulla Enterprise Health Care Centre Nursing Home	1st floor, 88, Jessore road, Calcutta - 74	20	PVT	N.HOME	
191	Sishu Niketan Diagnostic Pvt. Ltd.,	55, Rishi Arobindo Sarani, Kol - 90	20	PVT	N.HOME	
192	Speedage Hospital and Research Centre	848E, lake Town, Block-A, Kolkata - 89	20	PVT	N.HOME	
193	Vivo Care (P) Ltd.,(Care & Cure Nursing Home)	Surendranath Colony, Barasat, 24Pgns (N)	20	PVT	N.HOME	
194	Seva Nursing Home	Itendra Road, Jora Aswathatala Naihati, Basirhat, 24 Pgns (N)	16	PVT	N.HOME	
195	B.C. Memorial Eye Foundation	88 (63/A), Ghosh Para Road, Barrackpore, 24 Pgns (N)	15	PVT	N.HOME	EYE
196	Sankar Jyoti Eye Research Institute	196/5/1, M.S.Mukherjee Road, Khardaha, P.O. B.D. Sopan, P. S. : Khardah	15	PVT	N.HOME	EYE
197	Air Way Nursing Home	V.I.P. Road, Baguihati, Calcutta – 59,	15	PVT	N.HOME	
198	Avenue Nursing Home	Raghunathpur, P.O. Jyangra, 24 Pgns (N)	15	PVT	N.HOME	
199	Berachampa Sonar Bangla Nursing Home	Berachampa, Deganga, 24 Pgns (N)	15	PVT	N.HOME	
200	Health Care Nursing Home & Research Centre	88, Jessore Road, Kol - 74	15	PVT	N.HOME	
201	Health Cure Nursing & Research Centre	Block-A, Plot-677, Lake Town, kol - 89	15	PVT	N.HOME	

DISTRICT WISE LIST OF BEDDED HCUs IN WEST BENGAL

INVENTORY: ANNEXURE - I

Sl. No	Name of the Units.	Address	Current Bed	Organisation	Category General	Category Special
202	Institute Of Reproductive Medicine	DD - 18/5/1, Sec - I, Salt Lake, Kol - 64, North 24 Pgs.	15	PVT	N.HOME	
203	Lake Town Nursing Home	P-224, Block-B, Lake Town, Kolkata - 89	15	PVT	N.HOME	
204	Mother Terisa Memorial Care Home	36, B. T. Road, Talpukur Road, P.O. Naihati, 24 Pgs (N)	15	PVT	N.HOME	
205	New Suburban Nursing Home	102, Fidder Road, Belgharia, Kolkata - 56	15	PVT	N.HOME	
206	Nibedita Seva Sadan	Barasat, North 24 Parganas	15	PVT	N.HOME	
207	Nirbhar Nursing Home	497/1/1, East Ghoshpara Road, Pincal Babuquarter, P.O.: Garulia, Shyamnagar,	15	PVT	N.HOME	
208	Nirupama Seva Sadan	460/2, R. B. C. Road, Garifa, Naihati, North 24 Parganas	15	PVT	N.HOME	
209	Radharani Nursing Home	37, B. T. Road, Sastitala, P.O. Talpukur, 24 Pgs (N)	15	PVT	N.HOME	
210	Reive-Care Pvt. Ltd. (Care & Cure Nursing Home)	Surendranath Colony, P.O. Nabapally, Barasat, 24 Pgs (N)	15	PVT	N.HOME	
211	Santi Sadan Nursing Home	213/1, Dum Dum Road, Kol - 74	15	PVT	N.HOME	
212	Sunrise Nursing Home	Vill.: Naihati, P.O. Badartala, P.S.: Basirhat, Dist.: North 24 Parganas	15	PVT	N.HOME	
213	Unmesh - II (De-Addiction Center)	B.C. 1/11, Rajarhat Road, Kolkata - 59	15	PVT	N.HOME	
214	Nightangle Nursing Home	130, Kabi Guru Rabindra Path, Kanchrapara, P.S. Bizpur, 24 Pgs (N)	13	PVT	N.HOME	
215	Sishu Sanjiban Pvt. Ltd.,	DD-35, Salt Lake, Kol - 64	13	PVT	N.HOME	
216	Birajmohini Matri Sadan	Chandra Master Road, Nonachandanpukur, Barrackpore, North 24 Parganas	12	PVT	N.HOME	
217	Uttar Rabindra Nagar Sadan O Swastha Kendra	Vivekananda Road, P.O. Rabindra Nagar, Kol - 65	12	PVT	N.HOME	
218	Subodh Mitra Cancer Hospital & Research Centre	IB-175, Sec- III, Salt Lake, Cal - 91, 24 Pgs (N)	10	PVT	N.HOME	CAN
219	Alokan Eye Care Pvt. Ltd. (Eye Clinic)	162/A, Lake Town, Kolkata - 89	10	PVT	N.HOME	EYE
220	Orbit Eye Hospital & Research Centre	617, Jessore Road, Kolkata - 28	10	PVT	N.HOME	EYE
221	Spectra Eye Foundation (P) Ltd.,	108/1, Jessor Road, Madhyamgram, 24 Pgs (N)	10	PVT	N.HOME	EYE
222	Al Musafa Hospital	Baduria, P.O. Mandra, 24 Pgs (N)	10	PVT	N.HOME	
223	Ananda Nursing Home Research & Diagnostic Centre Pvt. Ltd.	29/1, 29/2, Block - C, Bangur Avenue, Kolkata - 55	10	PVT	N.HOME	
224	Aparna Nursing Home	161/2, P.K. Guha Road, Kolkata - 28	10	PVT	N.HOME	
225	Banani Nursing Home	Ashoknagar Station Road, 24 Pgs (N)	10	PVT	N.HOME	
226	Bangur Nursing Home	P - 71, Block -A, Bangur Avenue, Kolkata - 55	10	PVT	N.HOME	
227	Baranagar Nursing Home	118, B.T. Road, Kolkata - 35, 24 Pgn (N)	10	PVT	N.HOME	
228	Barasat Nursing Home	38, Jessore Road, Bijoly Park, Barasat, 24 Pgs. (N)	10	PVT	N.HOME	
229	Berachampa United Nursing Home	Barachampa, P. O. Debalaya, P.S.: Deganga, North 24 Pgs.	10	PVT	N.HOME	
230	Bijoy Krishna Memorial Santiniketan Nursing Home	Habra, Hospital Road, 24 Pgs(N)	10	PVT	N.HOME	
231	Birati Nursing Home Pvt. Ltd.,	2, Gopal Jew Mandir Road, Birati, Kol - 51	10	PVT	N.HOME	
232	BKM Santiniketan (Nursing Home & Polyclinic)	Habra Hospital Road, Habra, North 24Pgs	10	PVT	N.HOME	
233	Bongaon New Life Nursing Home	Gandhi Pally, P.O. Bongaon, North 24 Parganas	10	PVT	N.HOME	

DISTRICT WISE LIST OF BEDDED HCUs IN WEST BENGAL

INVENTORY: ANNEXURE - I

Sl. No	Name of the Units.	Address	Current Bed	Organisation	Category General	Category Special
234	Bongaon Nursing Home	Peadapara, P.O. Bongaon, 24 Pgns (N)	10	PVT	N.HOME	
235	Deshbandhu Nagar Hospital	Deshbandhunagar, Kolkata – 59	10	PVT	N.HOME	
236	Dolphin Nursing Home	Nivedita Place, Taki Road, Barasat, 24 Pgns (N)	10	PVT	N.HOME	
237	Dr. Ghos's Clinic & Nursing Home	37B, Rathtala, P.O. Barasat, 24 Pgns (N)	10	PVT	N.HOME	
238	Emergency Medical Service	9A, M. N. K. Road, North 24 Pgs	10	PVT	N.HOME	
239	Fair Health Nursing Home	Vill. Rani Park, Badu Road, P.O. Madhyamgram, 24 Pgns (N)	10	PVT	N.HOME	
240	Green View Clinic & Nursing Home	231/1, .R.B.C. Road, Naihati, 24 Pgns (N)	10	PVT	N.HOME	
241	Habra Nursing Home	Pramod Dasgupta Sarani, PO. Hijal Pukuria, P.S. Habra, 24 Pgns (N)	10	PVT	N.HOME	
242	Ichhamoti Nursing Home	P.O. & Vill. Dhalthitha, Basirhat, 24 Pgns (N)	10	PVT	N.HOME	
243	Ideal Nursing Home	163/24, Jessore Road, Kazipara, Barasat, 24 Pgns (N)	10	PVT	N.HOME	
244	Ideal Pathological Lab & Nursing Home	Banamalipur, 163/24, Jessore Road, Barasat, 24 Pgns (N)	10	PVT	N.HOME	
245	Jeeban Deep Nursing Home	Angrail, P.S. Gaighata, Bongaon, North 24 Pgs	10	PVT	N.HOME	
246	Jiban Dara Nursing Home	6/4, N. C. Mitra Road, Kol - 28	10	PVT	N.HOME	
247	Jiban Deep Nursing Home	15/A, Motilal Mallick Lane, Kolkata - 35	10	PVT	N.HOME	
248	Kolkata Nursing Home	Atghara, Rajarhat-Gopalpur, 24 Parganas (North)	10	PVT	N.HOME	
249	Krishna Sevayan Nursing Home	9, East Ghoshpara Road, P.O. Shyamnagar, 24 Pgns (N)	10	PVT	N.HOME	
250	Lake View Clinic & Nursing Maternity Home	P-334, Lake Town, Block-A, Kolkata - 89	10	PVT	N.HOME	
251	Life Nursing Home	505, Jessore Road, Nager Bazar, kol - 74	10	PVT	N.HOME	
252	Malancha Nursing Home	Talpukur Road, P.O. Naihati, 24 Pgns (N)	10	PVT	N.HOME	
253	Mon Nursing Home (Psychiatric)	V.I.P. Mondalganhi, P.O. R-Gopalpur, 24 Pgns (N)	10	PVT	N.HOME	
254	Naihati Health Care Institute	252, R. B. C. Road, Garifa, Naihati, 24 Pgns (N)	10	PVT	N.HOME	
255	Naihati Matri Sadan	11, Makeswar Ghat Road, P.O. Naihati, 24 Pgns (N)	10	PVT	N.HOME	
256	Nava Jeeban Nursing Home	95/1, Sri Krishnapur, Taki Road, P.O. Kajipara, Barasat	10	PVT	N.HOME	
257	Navajiban Nursing Home	Awalsiddhi More, Hisabi, 24 Pgns (N)	10	PVT	N.HOME	
258	New Barrackpore Nursing Home	8/2, Station Road (E), P.O. New Barrackpore, 24 Pgns (N)	10	PVT	N.HOME	
259	New Prantik Nursing Home & Research Centre Pvt. Ltd.,	Basirhat College Para, 24 Pgns (N)	10	PVT	N.HOME	
260	New Sundar Jiban Nursing Home	144/11, Jessore Road, Vill. Bijaynagar, P.O. Karipara,, 24 Pgns (N)	10	PVT	N.HOME	
261	New VIP Nursing Home	Kaikhali, V.I.P. Road, P.O. R Gopalpur, Kolkata -	10	PVT	N.HOME	
262	Nirupama Nursing Home	94/44B, K.N.C. Road, Barasat, 24 Pgns (N)	10	PVT	N.HOME	
263	Paribar Seva Swastha Merry Stopes Clinic	11No. Rail Gate, P.O. Nabapally, Barasat, 24 Pgns (N)	10	PVT	N.HOME	
264	Prantik Nursing Home & research Centre (P) Ltd.,	College Para, P.O.: Basirhat, 24 Parganas (North)	10	PVT	N.HOME	
265	Psychiatric Nursing Home	1 No. Swamiji Sarani	10	PVT	N.HOME	

DISTRICT WISE LIST OF BEDDED HCUs IN WEST BENGAL

INVENTORY: ANNEXURE - I

Sl. No	Name of the Units.	Address	Current Bed	Organisation	Category General	Category Special
266	Rahara Poly Clinic & Nursing Home	Khardaha Municipal Super Market, Kolkata 108, 24 Parganas (North)	10	PVT	N.HOME	
267	Rogmukti Nursing Home	98/70, G.L.T. Road, Calcutta - 36	10	PVT	N.HOME	
268	Saily Nursing Home	Habra, 24 Pgns (N)	10	PVT	N.HOME	
269	Salt Lake Medi Centre & Research Institute (J.R. Bankik Pvt.Ltd.)	DD-10, Sector – I, Salt Lake, North 24 Pgs.	10	PVT	N.HOME	
270	Saptarsi Nursing Home & Diagnostic Centre	Jessore Road, Habra, (Near Police St.), 24 Pgns (N)	10	PVT	N.HOME	
271	Sarada Seva Sadan	114, Barasat Road, P.O. Nonachandanpukur, 24 Pgns (N)	10	PVT	N.HOME	
272	SLC Medical Center & Research Ins.	DD-10, Sec - I, Salt Lake, Kol - 64	10	PVT	N.HOME	
273	Sodepur Dreamland Nursing Home Pvt. Ltd.,	4, B.M. Road, Natagarh, P.O. Sodepur, 24 Pgns (N)	10	PVT	N.HOME	
274	Sree Ramkrishna Matri Mangal Pratisthan	112, Feeder Road, Kamarhati, Ariadaha, Kolkata – 57	10	PVT	N.HOME	
275	Sudipta Nursing Home	Dakshinayan, Barasat Road, Amrabati More, Sodepur, 24 Pgns (N)	10	PVT	N.HOME	
276	Sundar Jiban Nursing Home	11/11,Taki Road, Barasat, 24 Pgns (N)	10	PVT	N.HOME	
277	Sundarban Nursing Home & Polyclinic	Berachampa (Kaukepara), P.O.: Develaya, P.S.: Deganga, N 24 Parganas	10	PVT	N.HOME	
278	Swarna Kamal Nursing Home	Badartala, Basirhat, 24 Parganas (North)	10	PVT	N.HOME	
279	Tapoban Nursing Home	Sarkar Market, Tentulia Road, Machlandapur, 24 Pgns (N)	10	PVT	N.HOME	
280	Upasam Maternity & Nursing Home	47/M, R.K. Ghosh Road, Kolkata - 50	10	PVT	N.HOME	
281	Agarwals Nursing Home	460/2 R. B. C. Road, Garifa, 24 Parganas (North)	9	PVT	N.HOME	
282	Chatterjee Nursing Home	9/64, Santra Para (Old Calcutta Road), Rahara, Mandirpara, 24 Pgns (N)	9	PVT	N.HOME	
283	Jivan Jyoti Nursing Home	B.L. No. 11, 64/1, Rustam Gumti, P.O. Jagatdal, 24 Pgns (N)	9	PVT	N.HOME	
284	Life Guard Nursing Home	DD-68, Narayantala (E), Aswininagar, Kolkata – 59	9	PVT	N.HOME	
285	Madhyamgram Kalyan Samity Prasuti Seva Sadan O Sishu Sadan	Debigarh, Sodepur Road, Madhyamgram, 24 Pgns (N)	9	PVT	N.HOME	MINTY
286	Nertralok Eye Care & Research Centre	Basirhat, 24 Pgns (N)	8	PVT	N.HOME	EYE
287	Apanjan Nursing Home	Jirakpur, Basirhat, North 24 Parganas	8	PVT	N.HOME	
288	Apollo Nursing Home	Narayantala Road, Deshbandhu Nagar, 24 Pgns (N)	8	PVT	N.HOME	
289	Eve's Care (Nursing Home)	108, Mitra Para Road, P.O.: Naihati, 24 Parganas (North)	8	PVT	N.HOME	
290	Paradise Nursing Home	10A, Nimchand Maitra Street, Kol - 35	8	PVT	N.HOME	
291	Udayan Nursing Home & Maternity Home	Vill. & P.O.: Badartala, P.S.: Basirhat, North 24 Parganas	7	PVT	N.HOME	
292	Prova Eye Care & Microsurgery	72/18 & 72/25, Ghoshpara Road, Lalkuthi, Barrackpore	6	PVT	N.HOME	EYE
293	Salt Lake Eye Foundation	IA/173, Salt Lake Kolkata - 700 097	6	PVT	N.HOME	EYE
294	Amita Nursing Home	Italgacha Road, Kol - 79	6	PVT	N.HOME	
295	Basirhat Bhabla Development Society for Mother & Child Health	Vill.: Bhabla Station Para, P.S.: Basirhat, North 24 Parganas	6	PVT	N.HOME	
296	Dr. B. B. Saha Polyclinic & Nursing Home	54, Jessor Road, Jaigachi, Habra, North 24 Pgs	6	PVT	N.HOME	
297	Jana Seva Nursing Home	Barachampa, P.O. Debalaya, 24 Pgns (N)	6	PVT	N.HOME	

DISTRICT WISE LIST OF BEDDED HCUs IN WEST BENGAL

INVENTORY: ANNEXURE - I

Sl. No	Name of the Units.	Address	Current Bed	Organisation	Category General	Category Special
298	Kamallata Polyclinic, Pathology & Susrusha Niketan	Holding No. - 439, Ward No. - 15, P.O. & P.S.: Hasnabad, North 24 Pgs	6	PVT	N.HOME	
299	Nabaday Health Clinic & Research Centre	Kalaberia, Rajarhat, 24 Pgns (N)	6	PVT	N.HOME	
300	Nirnay O Niramay – Sodepur Nursing Home	P.O. Sodepur, 24 Pgns (N)	6	PVT	N.HOME	
301	Barasat Eye (Day) Care Centre	Barasat, 24 Pgna (N)	5	PVT	N.HOME	EYE
302	Jeevan Joyti Eye Care & Micro Surgery Nursing Home	107, Feeder Road, Belghoria, Kolkata - 56, North 24 Pgs	5	PVT	N.HOME	EYE
303	Neha Eye Hospital & Research Centre	72/9, S.M.P. Sarani, Barrackpore, 24 Pgns (N)	5	PVT	N.HOME	EYE
304	Amiya Chatterjee Memorial Nursing Home	B.T. Road, Talpukur, 24 Parganas (North)	5	PVT	N.HOME	
305	Apollo Nursing Home	24/1, Kachari Road, Jagatdal, 24 Pgns (N)	5	PVT	N.HOME	
306	Argus Medical Research Centre	Kalyangarh, Rahara, 24 Pgns (N)	5	PVT	N.HOME	
307	Arogya Niketan Nursing Home	Kajipara, Barasat, Jessore Road, 24 Pgns (N)	5	PVT	N.HOME	
308	Asha Nursing Home	Port Blair Lane, Chiria More, BKP, 24 Pgns (N)	5	PVT	N.HOME	
309	Banerjee Clinic & Maternity Home	72/1, Rajkumar Mukherjee Road, Alambazar, Kolkata – 35	5	PVT	N.HOME	
310	Belgharia Nursing Home	55, B.L. Ghosh Road, P.O. Ariadaha, Kol - 57	5	PVT	N.HOME	
311	Bindubasini Nursing Home	76, Madhusudan Banerjee Road, Birati, Kolkata - 51	5	PVT	N.HOME	
312	Blue Bell Nursing Home	Thakurdas Banerjee Road, Belgharia, 24 Pgns (N)	5	PVT	N.HOME	
313	Blue Bird Nuring Home	College Road, Sahapur, P.O. Khantura, 24 Pgns (N)	5	PVT	N.HOME	
314	Care Nursing Home	2/1, Kachari Road, Jagatdal, Bhatpara, North 24 Parganas	5	PVT	N.HOME	
315	Care Point Nursing Home & Diagnostic Center	102/2, Srikrishnapur, Taki Road, Barasat, Kolkata - 124, North 24 Parganas	5	PVT	N.HOME	
316	Dipti Nuring Home	37, Shivtala Path, P.O. Athpur, Jagatdal, 24 Pgns (N)	5	PVT	N.HOME	
317	Dr. Amiya Chatterjee Memorial Nursing Home	36, B.T. Road, P.O. Talpukur, 24 Pgns (N)	5	PVT	N.HOME	
318	Dr. B.C. Roy Sishu Sadan	110, Fedeer Road, P.O. Ariadaha, Calcutta - 57, North 24 Pgs.	5	PVT	N.HOME	
319	Dr. Nityananda Arogya Niketan	P.O. & Vill. Machlandapur, Habra, 24 Pgns (N)	5	PVT	N.HOME	
320	Dr. S. D. Bakshi Eye Care Center	Bangaon, North 24 Pgs	5	PVT	N.HOME	
321	Dutta Pukur Seva Sadan & Maternity Home	Vill. Chalta Beria, P.O. Dutta Pukur, Jessore Road, 24 Pgns (N)	5	PVT	N.HOME	
322	Duttabad Maternity Home	South Dum Dum, Kolkata – 48	5	PVT	N.HOME	
323	Ganga Nursing Home	Chakdah Road, Bongaon, 24 Parganas (North)	5	PVT	N.HOME	
324	Goodwill Welfare Association Seva Sadan (Seva Sadan)	Uttarpara, Rahara, North 24 Parganas	5	PVT	N.HOME	
325	Gramin Health Care & Eye Day Care Center	R.V.C. Maheshpur, P.O.: Badu, P.S.: Barasat, 24 Pgs North	5	PVT	N.HOME	
326	Green View Nursing Home	30, B.T. Road, Dhankal Bus Stop, P.O. Panihati, 24 Pgn (N)	5	PVT	N.HOME	
327	Henry Grey Nursing Home	1 No. Rail Gate, Jirat Road, P.O. & P.S.: Habra, North 24 Parganas	5	PVT	N.HOME	
328	Iswaripur Nursing Home	Vill. Iswaripur, P.O. Bandipur, 24 Pgns (N)	5	PVT	N.HOME	
329	Janakalyan Nursing Home	Tentulia Road, Vill. & P.O. Machlandapur, 24 Pgns (N)	5	PVT	N.HOME	

DISTRICT WISE LIST OF BEDDED HCUs IN WEST BENGAL

INVENTORY: ANNEXURE - I

Sl. No	Name of the Units.	Address	Current Bed	Organisation	Category General	Category Special
330	Kanchrapara Nursing Home	4, Aguipara, Kanchrapara, 24 Pgns (N)	5	PVT	N.HOME	
331	Medicare Nursing Home	Barasat Road, BKP, 24 Pgns (N)	5	PVT	N.HOME	
332	Medicare Nursing Home	CJ-125, Sector – II, Salt Lake, Kolkata - 91	5	PVT	N.HOME	
333	Monorama Nursing Home	Durga Nagar, P.O. Rabindra Nagar, North 24 Pgs.	5	PVT	N.HOME	
334	Mriganayani Nursing Home	Vill.: Udayanpally, P.O.: Prithiba, North 24 Parganas	5	PVT	N.HOME	
335	Nabonur Nursing Home	Dandirhat Bazar, P.S.: Basirhat, North 24 Parganas	5	PVT	N.HOME	
336	Nandan Nursing Home	179/A, Old Calcutta Road, Madhumalancha, Talpukur, 24 Pgns (N)	5	PVT	N.HOME	
337	Netaji Seva Samity	Suryapur, Nilgunj, North 24 Pgs.	5	PVT	N.HOME	
338	New Everest Nursing Home	158, Dum Dum Road, Calcutta - 74	5	PVT	N.HOME	
339	New Glory Nursing Home	1, Jowpur Road, Dum Dum, Kolkata – 74	5	PVT	N.HOME	
340	New Life Nursing Home	19/C, Gupter Bagan, Moti Bhavan, Jagatdal, 24 Pgns (N)	5	PVT	N.HOME	
341	Orient Nursing Home	Barachapa, Debalaya, P.S. Deganga, 24 Pgns (N)	5	PVT	N.HOME	
342	P.G. Nursing Home	Atghara, Haroa, 24 Parganas (North)	5	PVT	N.HOME	
343	Panihati Nursing Home	B.T. Road, Panihati, 24 Pgns (N)	5	PVT	N.HOME	
344	Punam Nursing Home	Ratepara, Chakdaha Road, Bongaon, 24 Parganas (North)	5	PVT	N.HOME	
345	Rita Skin Foundation	G. D. - 381, Sec - III, Saltlake, Kol - 91	5	PVT	N.HOME	
346	Saha Nursing Home	Bhadra Shyamvila, Kolkata – 79, 24 Pgns (N)	5	PVT	N.HOME	
347	Santi Surgical & Maternity Centre	156, B.N. Banerjee Road, Kolkata - 56	5	PVT	N.HOME	
348	Sathi Nursing Home	Tentulia, Krishnamoyee market, P.S.: Swarupnagar, 24 Pgns (N)	5	PVT	N.HOME	
349	Seba Sadan & Maternity Home	Chaltaberia Natun Rasta More, Duttapukur, North 24 Parganas	5	PVT	N.HOME	
350	Sebayan	Hena Para, Krishnapur, Kolkata – 59	5	PVT	N.HOME	
351	Sen's Clinic	AA-73, Sec - I, Saltlake, Kol - 64	5	PVT	N.HOME	
352	Shusruta Nursing Home Pvt. Ltd.,	1, A.M. Basu Road, Kol - 74	5	PVT	N.HOME	
353	Shyamnagar Nursing Home	P.O.: Shyamnagar, P.S.: Noapara, 24 Pgns (N)	5	PVT	N.HOME	
354	Sinthee Arogyayan Nursing Home	24/2/36, Mondal Para Lane, Sinthee, Kolkata - 50, North 24 Pgs.	5	PVT	N.HOME	
355	Sree Onkarnath Seva Kendra	7/7, PWD Road,	5	PVT	N.HOME	
356	Sree Ramkrishna Seva Sadan Nursing Home	Gobardanga Rail Station, Sahapur, P.O. Khanwer, 24 Pgns (N)	5	PVT	N.HOME	
357	Subhas Chandra Seva Sadan (organized by Netaji Seva Samity)	Sukanta Pally, Gheedah, Nilgunge Bazar, 24 Pgns (N)	5	PVT	N.HOME	
358	Sudevi Nursing Home	Durganagar Station Road, Kolkata – 65	5	PVT	N.HOME	
359	Sushruta Nursing Home	1, A.M. Basu Road, Kolkata – 74	5	PVT	N.HOME	
360	Naihati Pathology Centre	36, R. B. C. Road, PO & PS Naihati, 24 Pgns (N)	5	PVT	N.HOME	
361	Deb Deep Eye Clinic	Chakdah Road, Bongaon, 24 Pgns (N)	4	PVT	N.HOME	EYE

DISTRICT WISE LIST OF BEDDED HCUs IN WEST BENGAL

INVENTORY: ANNEXURE - I

Sl. No	Name of the Units.	Address	Current Bed	Organisation	Category General	Category Special
362	Habra Eye Care Center	329, Jessore Road, Habra, 24 Pgns (N)	4	PVT	N.HOME	EYE
363	Late Amritalal Gupa Charitable Dispensary (Eye Surgical Unit)	111, Deshbandhu Road (W), Kolkata – 35.	4	PVT	N.HOME	EYE
364	Swasti Eye Care & Super speciality Nursing Home	HJ/3 & HJ/6, Rajarhat Road, Taltala, Baguiati, Kol - 59	4	PVT	N.HOME	EYE
365	Artha Seva Sadan	Nonapara, P.O. Garulia, 24 Pgns (N)	4	PVT	N.HOME	
366	Barasat Kalyan Samiti	Bhadrabari, Nabapally, Barasat, North 24 Pgs,	4	PVT	N.HOME	
367	Belgharia Seva Sadan	17, Umesh Mukherjee Road, Belgharia, 24 Pgns (N)	4	PVT	N.HOME	
368	Care Nursing Home	Habra, 172, Nagarukhra Road, Kamarthuba, 24 Pgns (N)	4	PVT	N.HOME	
369	Central Nursing Home	3, Gopal Lal Tagore Road, Kol -36	4	PVT	N.HOME	
370	Damodar Seva Sadan	P.O. & Vill. Dhalthitha, Basirhat, 24 Pgns (N)	4	PVT	N.HOME	
371	Dr. Kamala Basu Nursing Home & Maternity Clinic	71, Jan Mahammad Maszid Ghat Road, P.O.&P.S.Naihati, North 24 Pgs	4	PVT	N.HOME	
372	Gobardanga City Nursing Home Poly Clinic & Diagnostic Centre	Sahapur, Gobardanga, 24 Pgns (N)	4	PVT	N.HOME	
373	Jaya Maternity & Nursing Home	45, Maa Brajendra Dutta Road, Kolkata – 28	4	PVT	N.HOME	
374	Maa Sarada Maternity & Nursing Home	VIP Road, Mondal Gunthi, Kaikhali, P.O.: Airport, Kol - 52	4	PVT	N.HOME	
375	Maslandapur Pally Unnayan Samity	Maslandapur, 24 Parganas (North)	4	PVT	N.HOME	
376	Maternity & Nursing Home	Garulia Main Road, P.O. Garulia, 24 Pgns (N)	4	PVT	N.HOME	
377	Mukhjee Nursing & Maternity Home	Vill& P.O. Gangrapota, Bongaon, 24 Pgns (N)	4	PVT	N.HOME	
378	Namita Maternity & Nursing Home	Garulia, Noapara, 24 Pgns (N)	4	PVT	N.HOME	
379	Nayan Jyoti Eye Care	42/1, Dr. Meghnath Saha Road, Kolkata – 74	4	PVT	N.HOME	
380	New Barrackpore Nursing Home	39, B.T. Road, P.O. Talpukur, 24 Pgns (N)	4	PVT	N.HOME	
381	Nursing & Maternity Home	71, Jan Md. Ghat Road, Mahakali Tala, Naihati, 24 Pgns (N)	4	PVT	N.HOME	
382	Sarala Surgical Clinic	53/5, Bidyatan Sarani, Kol - 35	4	PVT	N.HOME	
383	Sodepore Nursing Home Pvt. Ltd.,	Barasat Road, P.O. Sodepur, 24 Pgns (N)	4	PVT	N.HOME	
384	The Subala Clinic & Nursing Home	Kaikhali Chiria More, Kaikhali Road, Kolkata – 52	4	PVT	N.HOME	
385	Vijoy Optic & Poly Clinic	R.N. Tagore Road, East Station Road, Agarpara, 24 Pgns (N)	4	PVT	N.HOME	
386	Bidrikshya (Eye day care unit)	Khardaha, 24 Parganas (North)	3	PVT	N.HOME	EYE
387	Bongaon Eye Care Centre	Court Road, Bongaon	3	PVT	N.HOME	EYE
388	Eye Care Nursing Home	Amarabati, P.O. Sodepur, 24 Pgns (N)	3	PVT	N.HOME	EYE
389	Eye Land Micro Surgery Centre	5, Anandapuri Middle Road, Nona Chandanpukur, Barrackpore,	3	PVT	N.HOME	EYE
390	Insight (Eye Micro Surgery)	Belgharia, Calcutta – 56, 24 Pgns (N)	3	PVT	N.HOME	EYE
391	Mukherjee Eye Nursing Home	2, Baroda Road, Naihati, Near Katayani H School,	3	PVT	N.HOME	EYE
392	Noor Eye Care Center	No-18, East Ghoshpara Road, Block No-12, P.O.: Kankinara,	3	PVT	N.HOME	EYE

DISTRICT WISE LIST OF BEDDED HCUs IN WEST BENGAL

INVENTORY: ANNEXURE - I

Sl. No	Name of the Units.	Address	Current Bed	Organisation	Category General	Category Special
393	Rastraguru Surendra Nath Eye Institute	S. N. Banerjee Road, Manirampur, North 24 Parganas	3	PVT	N.HOME	EYE
394	Vision Eye Microsurgery Centre	Trimohini, P.O. & P.S.: Basirhat, 24 Pgs (N)	3	PVT	N.HOME	EYE
395	Barrackpore Nursing Home	60(51/1), Ghosh Para Road, Barrackpore, 24 Pgs (N)	3	PVT	N.HOME	
396	Basirhat Nursing Home	P.O.: Basirhat, North 24 Parganas	3	PVT	N.HOME	
397	Garden View Nursing Home	44, East Ghosh Para Road, Kankinara, 24 Parganas (North)	3	PVT	N.HOME	
398	Heart N Gut Clinic (P) Ltd. (Day Care Center)	81, Jessor Road, Kol - 74	3	PVT	N.HOME	
399	Matri Sadan O Swastha Kendra	Vivekananda Road, Kol - 65	3	PVT	N.HOME	
400	Prince Nursing Home	Garulia, 24 Parganas (North)	3	PVT	N.HOME	
401	Sanjeevan Nursing Home	444, Garulia Main Road, P.O.: Garulia, North 24 Parganas	3	PVT	N.HOME	
402	Saradamoyee Seva Sadan (M.T.P. Center)	Prasannakanan, Gobardanga, North 24 Pgs	3	PVT	N.HOME	
403	Sarbanu Nursing Home	Sajirhat, New Barrackpore, 24 Pgs (N)	3	PVT	N.HOME	
404	Sraboni Nursing Home	Sajirhat, P.O.: New BKPR, P.S.: Ghola, 24 Pgs (N)	3	PVT	N.HOME	
405	Vivekananda Seva Sadan	47/1, Sabuj Pally, D.P. Nagar, Kolkata - 56	3	PVT	N.HOME	
406	Dr. J.J. Ghosh Eye Care and Eye Micro Surgery	Colony More, Nabapally, Barasat, 24 Pgs (N)	2	PVT	N.HOME	EYE
407	Pranabjyoti Eye Clinic	1, Narendranagar, P.O. & P.S.: Belghoria, Kolkata - 56	2	PVT	N.HOME	EYE
408	Purnajyoti Eye Care (Day Care Centre)	153/155, New Colony, Paschim Para, P.O.: Rahara, P.S.: Khardah, 2	2	PVT	N.HOME	EYE
409	Sudipa Eye Care	Shyamnagar, 24 Pgs (N)	2	PVT	N.HOME	EYE
410	Annapurna Clinic	3, Raghunathpur, P.O.Raghunathpur, 24 Pgs (N)	2	PVT	N.HOME	
411	Debnaryan Seva Pratisthan	14, P.K. Biswas Road, Khardah, 24 Pgs (N)	2	PVT	N.HOME	
412	Lab-O-Aid Polyclinic & Eye Microsurgery	17, T. N. Biswas Road, Alambazar, Dakshinashwar, Kol - 35	2	PVT	N.HOME	
413	Matri Mangal Nursing Home	G-1, Narayantala East, Baguihati, Kol - 59	2	PVT	N.HOME	
414	New Central Nursing Home	28/24, A.N. Deo Path, Titagarh, 24 Pgs (N)	2	PVT	N.HOME	
415	Nivedita Sishu Sadan	20/1, T. N. Chatterjee Street, Kol - 90	2	PVT	N.HOME	
416	Orbis Eye & Dental Daycare Center	4, Thakurdas Banerjee Road, P.O. & P.S.: Belghoria, Kolkata - 56,	2	PVT	N.HOME	
417	Paribar Kalyan Kendra	Halisahar, Jetiabazar, 24 Pgs (N)	2	PVT	N.HOME	
418	Polyclinic & Day Care Centre	7B, Motijheel Avenue, Kolkata - 74	2	PVT	N.HOME	
419	Manoj Mody Foundation Dialysis Centre	Kalyan Bhawan, Kalyan Nagar, PO. Panshila, PS. Khardah,	Day care	PVT	N.HOME	
		TOTAL NUMBER OF BEDS IN NORTH 24 PARGANAS DISTRICT:	9587			

DISTRICT WISE LIST OF BEDDED HCUs IN WEST BENGAL

INVENTORY: ANNEXURE - I

Sl. No	Name of the Units.	Address	Current Bed	Organisation	Category General	Category Special
PURULIA						
1	Deben Mahato Hospital (Dist. Hospital)	P.O. Purulia, Dist. Purulia	500	GOVT	DH	
2	S.D. Hospital – Raghunathpur	P.O. & P.S. Raghunathpur, Dist. Purulia	68	GOVT	SD	
3	Bansgarh Rural Hospital	Balarampur, P.O. Rangadih, Purulia	30	GOVT	RH	
4	Harmadih Rural Hospital	Neturia, Harmadih, Purulia	30	GOVT	RH	
5	Hura Rural Hospital	P.O. Hura, Dist. Purulia	30	GOVT	RH	
6	Kotshila Rural Hospital	Kotshila, Purulia	30	GOVT	RH	
7	Manbajar Rural Hospital	Manbazar, Purulia	30	GOVT	RH	
8	Muralhar Kotshila Rural Hospital	Jhaldah, P.O. Jindaru, Purulia	30	GOVT	RH	
9	Banda (Chelyama) BPHC	Raghunathpur, P.O. Chelyama, Purulia	15	GOVT	BPHC	
10	Barabajar BPHC	Barabazar, Purulia	15	GOVT	BPHC	
11	Bari BPHC	Manbazar, P.O. Bari, Purulia	15	GOVT	BPHC	
12	Bundwan BPHC	Bundwan, Purulia	15	GOVT	BPHC	
13	Chakaltore BPHC	Purulia, P.O. Chakaltore, Purulia	15	GOVT	BPHC	
14	Jaipur BPHC	Jaipur, Purulia	15	GOVT	BPHC	
15	Jhaldah BPHC	Jhaldah, P.O. Jhaldah, Purulia	15	GOVT	BPHC	
16	Kolloli BPHC	Kashipur, P.O. Panchakotraj, Purulia	15	GOVT	BPHC	
17	Kushtor BPHC	Purulia – II, P.O. Kushtor, Purulia	15	GOVT	BPHC	
18	Muradih BPHC	Santuri, P.O. Muradih, Purulia	15	GOVT	BPHC	
19	Para BPHC	Para, P.O. Para, Purulia	15	GOVT	BPHC	
20	Pathardihi BPHC	Bagmundi, Pathardihi, Purulia	15	GOVT	BPHC	
21	Puncha BPHC	Puncha, Purulia	15	GOVT	BPHC	
22	Raghunathpur BPHC	Raghunathpur - I, P.O.: Raghunathpur, Purulia	15	GOVT	BPHC	
23	Sirkabad BPHC	Arsha, P.O. Sirkabad, Purulia	15	GOVT	BPHC	
24	Ajodhya Hill PHC	Bagmundi, P.O. Ajodhya, Purulia	12	GOVT	PHC	
25	Arsha PHC	Arsha, Purulia	6	GOVT	PHC	
26	Babudergram PHC	Raghunathpur, P.O. Sanko, Purulia	6	GOVT	PHC	
27	Balitora PHC	Santuri, P.O. Balitora, Purulia	6	GOVT	PHC	
28	Bhamuria PHC	Neturia, P.O. Bhamuria, Purulia	6	GOVT	PHC	
29	Chayanpur PHC	Purulia – II, P.O. Chayanpur, Purulia	6	GOVT	PHC	
30	Darikuri PHC	Jaipur, P.O. Sidhi, Purulia	6	GOVT	PHC	
31	Fusrabaid PHC	Fusrabaid, Purulia	6	GOVT	PHC	

DISTRICT WISE LIST OF BEDDED HCUs IN WEST BENGAL

INVENTORY: ANNEXURE - I

Sl. No	Name of the Units.	Address	Current Bed	Organisation	Category General	Category Special
32	Gurpur PHC	Bundwan, P.O. Gurpur, Purulia	6	GOVT	PHC	
33	Kantarangini PHC	Kashipur, P.O. Kantarangini, Purulia	6	GOVT	PHC	
34	Kroshjuri PHC	Kashipur, P.O. Kroshjuri, Purulia	6	GOVT	PHC	
35	Ladhurka PHC	Hura, P.O Ladhurka, Purulia	6	GOVT	PHC	
36	Lagda PHC	Purulia – I, P.O. Lagda, Purulia	6	GOVT	PHC	
37	Mahatomara PHC	Jhaldah, P.O. Mahatomara, Purulia	6	GOVT	PHC	
38	Malti PHC	Balarampore, P.O. Malti, Purulia	6	GOVT	PHC	
39	Nekray PHC	Balarampore, P.O. Nekray, Purulia	6	GOVT	PHC	
40	Nowagarh PHC	Puncha, P.O. Raj Nowagarh, Purulia	6	GOVT	PHC	
41	Phursrabad PHC	Para, Phursrabad, Purulia	6	GOVT	PHC	
42	Pichasi PHC	Purulia-I, P.O. Pichasi, Purulia	6	GOVT	PHC	
43	Sindhri PHC	Barabazar, P.O. Sindhri, Purulia	6	GOVT	PHC	
44	Tunturi PHC	Bagmundi, Tunturi, Purulia	6	GOVT	PHC	
45	Ankro PHC	Manbazar, P.O. Ankro, Purulia	4	GOVT	PHC	
46	Bagda PHC	Puncha, P.O. Bagda, Purulia	4	GOVT	PHC	
47	Bamundiha PHC	Barabazar, P.O. Bamundiha, Purulia	4	GOVT	PHC	
48	Baragram PHC	Jaipur, P.O. Baragram, Purulia	4	GOVT	PHC	
49	Begunkodore PHC	Jaldah, P.O. Begunkodore, Purulia	4	GOVT	PHC	
50	Biltora PHC	Raghunathpur, P.O. Gadibera, Purulia	4	GOVT	PHC	
51	Bogra PHC	Raghunathpur, P.O. Bogra, Purulia	4	GOVT	PHC	
52	Chatumadar PHC	Hura, P.O. Chatumadar, Purulia	4	GOVT	PHC	
53	Dighi PHC	Manbazar, P.O. Dighi, Purulia	4	GOVT	PHC	
54	Hutmura PHC	Purulia – II, P.O. Hutmura, Purulia	4	GOVT	PHC	
55	Ilu PHC	Jhaldah, P.O. Ilu, Purulia	4	GOVT	PHC	
56	Kantadih PHC	Arsha P.O. Kantadih, Purulia	4	GOVT	PHC	
57	Karang PHC	Bagmundi, P.O. Karang, Purulia	4	GOVT	PHC	
58	Kerwa PHC	Bslarampore, P.O. Kerwa, Purulia	4	GOVT	PHC	
59	Khairipihira PHC	Hura, P.O. Khairipihira, Purulia	4	GOVT	PHC	
60	Kuda PHC	Manbazar, P.O. Mohara, Purulia	4	GOVT	PHC	
61	Nadiha PHC	Para, P.O. Nadiha, Purulia	4	GOVT	PHC	
62	Nildhiha PHC	Raghunathpur, P.O. Nildhiha, Purulia	4	GOVT	PHC	
63	Pairachali PHC	Manbazar, P.O. Pairachali, Purulia	4	GOVT	PHC	

DISTRICT WISE LIST OF BEDDED HCUs IN WEST BENGAL

INVENTORY: ANNEXURE - I

Sl. No	Name of the Units.	Address	Current Bed	Organisation	Category General	Category Special
64	Santuri PHC	P.O.: Santuri, Purulia	4	GOVT	PHC	
65	Sidhi PHC	Jaipur, P.O. Sidhi, Purulia	4	GOVT	PHC	
66	Talajuri PHC	Kashipur, P.O. Gourandih, Purulia	4	GOVT	PHC	
67	Agardih PHC	Kashipur, P.O. Agardih, Purulia	2	GOVT	PHC	
68	Anandawip (Kuruktopa) PHC	Puncha, P.O. Kuruktopa, Purulia	2	GOVT	PHC	
69	Ashar Bandh PHC	Para, P.O. Tentulbati, Purulia	2	GOVT	PHC	
70	Bartoria PHC	Neturia, P.O. Bartoria, Purulia	2	GOVT	PHC	
71	Basantapur PHC	Manbazar, P.O. Basantapur, Purulia	2	GOVT	PHC	
72	Belkuri PHC	Purulia-I, P.O. Belkuri. Purulia	2	GOVT	PHC	
73	Chirudih PHC	Bundwan, P.O. Chirudih, Purulia	2	GOVT	PHC	
74	Jamtoria PHC	Manbazar, P.O. Jamtoria, Purulia	2	GOVT	PHC	
75	Khatanga PHC	Jaldah, P.O. Khatanga, Purulia	2	GOVT	PHC	
76	Latapara PHC	Bundwan, P.O. Latapara, Purulia	2	GOVT	PHC	
77	Raibandh phc	Neturia, P.O. Gunara, Purulia	2	GOVT	PHC	
78	Purulia Mental Hospital	P.O. & Dist. Purulia	200	GOVT	MNH	
79	Santaldih Thermal Hospital	P.O. Santaldih, Dist. Puruliya	10	GOVT	SEB	
80	Purulia Jail Hospital	P.O. & Dist. Purulia	33	GOVT	SGJ	
81	Purulia Police Hospital	P.O. & Dist. Purulia	20	GOVT	SGP	
82	South Eastern Rly. Hospital – Adra	Adra, P.O. Kashipur, Purulia	198	GOVT	RLY	
83	Netaji Eye & General Hospital	Santuri, P.O. Ramchandrapur, Purulia	250	PVT	N.HOME	
84	Nabakustha Nibas	Balarampur, P.O. & Dist. Purulia	212	PVT	N.HOME	LEPR
85	Purulia Leprosy Home & Hospital	P.O. Box No.: 09, P.O. & Dist. Purulia	150	PVT	N.HOME	LEPR
86	Gandhi Memorial Leprosy Foundation	Balarampur, P.O. & Dist. Purulia	20	PVT	N.HOME	LEPR
87	Rameswari Singhania Seva Pratisthan Maternity/Nursing Home	West Lake Road, P.O. & Dist. Purulia	20	PVT	N.HOME	
88	Sanjeevani Nursing Home	North Lake Road, Purulia – 723 101	20	PVT	N.HOME	
89	The Leprosy Mission	P.O. Jhalda, Purulia	15	PVT	N.HOME	LEPR
90	Maa Kalyani Nursing Home	Adra Road, Raghunathpur, Purulia	10	PVT	N.HOME	
91	Rotary Service Centre	P.O. Puruliya, Dist. Purulia	10	PVT	N.HOME	
92	Purulia Lions Binoy Khedia Eye Hospital	North Lake Road, Purulia – 723 101	5	PVT	N.HOME	EYE
93	Life Line Maternity/Nursing Home	Sarat Sen Compound, Amidiha, P.O. & Dist. Purulia	5	PVT	N.HOME	
94	Roy's Maternity/Nursing Home	Barakar Road, P.O. & Dist. Purulia	5	PVT	N.HOME	
95	Swarupananda Seva Sadan & Nursing Home	New Baghmundi Road, Jhalda, Purulia	5	PVT	N.HOME	
		TOTAL NUMBER OF BEDS IN PURULIA DISTRICT:	2403			

DISTRICT WISE LIST OF BEDDED HCUs IN WEST BENGAL

INVENTORY: ANNEXURE - I

Sl. No	Name of the Units.	Address	Current Bed	Organisation	Category General	Category Special
SOUTH 24 PARGANAS						
1	S. D. Hospital – Diamond Harbour	Diamond Harbour, South 24 Pgs	125	GOVT	SD	
2	S.D. Hospital – Kakdwip	Kakdwip, Dist. South 24 Parganas, PIN. 743347	100	GOVT	SD	
3	S.D. Hospital – Baruipur	Baruipur, South 24 Pgs	68	GOVT	SD	
4	S.D. Hospital – Canning	Canning, South 24 Pgs	68	GOVT	SD	
5	Garden Reach State General Hospital	Garden Reach, Metiaburuz, South 24 Pgs	15	GOVT	SGH	
6	Mathurapur Rural Hospital	Mathurapur - I, South 24 Pgs	60	GOVT	RH	
7	Sagar Rural Hospital	Vill+P.O. Rabindranagar, P.S.: Sagar,Dist.: Paschim Medinipore	60	GOVT	RH	
8	Amtola Rural Hospital	Bishnupur - II, Amtola, South 24 Pgs	50	GOVT	RH	
9	Raydighi Rural Hospaital	Mathurapur - II, Raydighi, South 24 Pgs	50	GOVT	RH	
10	Lakshimbala Dutta (Muchisa) Rural Hospital	Budgebudge - II, Bakrahat, South 24 Pgs	30	GOVT	RH	
11	Sri Ramkrishna (Nimpith) Rural Hospital	Joynagar - II, Radhanagar, South 24 Pgs	30	GOVT	RH	
12	Jaynagar Rural Hospital	Kultali, Jaynagar, South 24 PGS	25	GOVT	RH	
13	Sonarpur Rural Hospital	Kotalia (Subhasgram), Sonarpur, South 24 Pgs	25	GOVT	RH	
14	Padmarhat Rural Hospital	Joynagar - I, Dakshin BarasatSouth 24 Pgs	15	GOVT	RH	
15	Banjanheria (Charial) BPHC	Budgebudge - I, Butia, South 24 Pgs	20	GOVT	BPHC	
16	Dwakriknagar BPHC	Namkhana, Dwariknagar, South 24 Pgs	15	GOVT	BPHC	
17	Kulpi BPHC	Kulpi, South 24 Pgs	15	GOVT	BPHC	
18	Mograhat BPHC	Mograhat - II, South 24 Pgs	15	GOVT	BPHC	
19	Netra (Panchasgram) BPHC	Diamond Harbour - I, Panchagram Singhberia, South 24 Pgs	15	GOVT	BPHC	
20	Samali BPHC	Bishnupur - II, Nahajari, South 24 Pgs	15	GOVT	BPHC	
21	Sarisha BPHC	Diamond Harbour - II, Sarisha, South 24 Pgs	15	GOVT	BPHC	
22	Sarsuna BPHC	Thakurpukur - Metiaburuj, Sarsuna Metiaburuj, South 24 Pgs	15	GOVT	BPHC	
23	Nalmuri BPHC	Bhangore - I, Naraynpur, Dist. South 24 Pgs	12	GOVT	BPHC	
24	Baneswarpur PHC	Mograhat - I, Baneswarpur, South 24 Pgs	10	GOVT	BPHC	
25	Basanti BPHC	Basanti, South 24 PGS	10	GOVT	BPHC	
26	Chandidoulatabad BPHC	Bishnupur - I, Nepalgunj via Chandi, South 24 Pgs	10	GOVT	BPHC	
27	Falta BPHC	Falta, South 24Pgs	10	GOVT	BPHC	
28	Gosaba BPHC	Gosaba, South 24 PGS	10	GOVT	BPHC	
29	Jirongacha BPHC	Bhangore - II, Hatisala, Dist South 24 Pgs	10	GOVT	BPHC	
30	Madhabnagar BPHC	Patharpratima, South 24 Pgs	10	GOVT	BPHC	
31	Matherdighi BPHC	Canning - II, MatherdighiSouth 24PGS	10	GOVT	BPHC	

DISTRICT WISE LIST OF BEDDED HCUs IN WEST BENGAL

INVENTORY: ANNEXURE - I

Sl. No	Name of the Units.	Address	Current Bed	Organisation	Category General	Category Special
32	Naiyarhat BPHC	Mandirbajar, Naiyarhat, South 24 Pgs	10	GOVT	BPHC	
33	Sirakhel PHC	Mograhat - I, Sirakhole, South 24 Pgs	20	GOVT	PHC	
34	Brajaballabhpur PHC	Patharpratima, Brajaballabhpur, South 24 Pgs	15	GOVT	PHC	
35	Amgachia PHC	Bishnupur - I, Nepalgunj, South 24 Pgs	10	GOVT	PHC	
36	Bardrone PHC	Diamond Harbour - I, Hatuganj, South 24 Pgs	10	GOVT	PHC	
37	Bhangore PHC	Bhangore - II, South 24 Pgs	10	GOVT	PHC	
38	Chhoto Mollakhali PHC	Gosaba, Chhoto Mollakhali, South 24 PGS	10	GOVT	PHC	
39	Gadamathura PHC	Patharpratima, Gadamathura, South 24 Pgs	10	GOVT	PHC	
40	Hariharpur PHC	Baruipur, Mallikpur South 24 Pgs	10	GOVT	PHC	
41	Mohonpur PHC	Mograhat - II, Mohonpur, South 24 Pgs	10	GOVT	PHC	
42	Bagdanga Mousini PHC	Namkhana, Mousini, South 24 Pgs	6	GOVT	PHC	
43	Indrapur PHC	Vill+P.O. Indrapore (G - Plot), P.S. Pattharpratima, Dist. South 24 Pgs	6	GOVT	PHC	
44	Baribhangadabad PHC	Mathurapur - II, Baribhangadabad, South 24 Pgs	6	GOVT	PHC	
45	Belpukur PHC	Kulpi, Belpukur, South 24 Pgs	6	GOVT	PHC	
46	Bhatipota PHC	Bhangore - I, Beonta, South 24 Pgs	6	GOVT	PHC	
47	Bhubaneswari PHC	Kultali, Bhubanaswari, South 24 PGS	6	GOVT	PHC	
48	Birajlakshmi PHC	Budgebudge - I, Pujali, South 24 Pgs	6	GOVT	PHC	
49	Burul PHC	Budgebudge - II, Burul, South 24 Pgs	6	GOVT	PHC	
50	Dakshin Jagadishpur PHC	Mandirbajar, Jagadishpur South 24 Pgs	6	GOVT	PHC	
51	Dhaltikuria PHC	Falta, Charberia, South 24 Pgs	6	GOVT	PHC	
52	Dhosa Indrapala PHC	Joynagar - I, Chattoberia South 24 Pgs	6	GOVT	PHC	
53	Fartabad PHC	Sonarpur, Garia, South 24 Pgs	6	GOVT	PHC	
54	Garfa PHC	Thakurpukur - Metiaburuj, Garfa, South 24 Pgs	6	GOVT	PHC	
55	Ghat Bakultala PHC	Mathurapur - I, Bakultala, South 24 Pgs	6	GOVT	PHC	
56	Gilarchat PHC	Mathurapur - II, Gilarchat South 24 Pgs	6	GOVT	PHC	
57	Gojapoali PHC	Budgebudge - II, Poali, South 24 Pgs	6	GOVT	PHC	
58	Gokarni PHC	Mograhat - II, Gokarni, South 24 Pgs	6	GOVT	PHC	
59	Harendranagar PHC	Kakdwip, Harendranagar, South 24 Pgs	6	GOVT	PHC	
60	Herobhanga - Jharkhali PHC	Basanti, Jharkhali Bazar South 24 PGS	6	GOVT	PHC	
61	Indrapala PHC	Baruipur, Kudrali, South 24 Pgs	6	GOVT	PHC	
62	Indrapur (G - Plot) PHC	Patharpratima, Indrapur, South 24 Pgs	6	GOVT	PHC	
63	Jadavpur PHC	Mathurapur - I, Jadavpur, South 24 Pgs	6	GOVT	PHC	

DISTRICT WISE LIST OF BEDDED HCUs IN WEST BENGAL

INVENTORY: ANNEXURE - I

Sl. No	Name of the Units.	Address	Current Bed	Organisation	Category General	Category Special
64	Joynagar PHC	Sutahata, P.O.: Doro Joynagar, South 24 Parganas	6	GOVT	PHC	
65	Julpia PHC	Bishnupur - I, Andharmanik, South 24 Pgs	6	GOVT	PHC	
66	Kaikhali (GopalGunj) PHC	Kultali, Kaikhali, South 24 PGS	6	GOVT	PHC	
67	Kalikapur PHC	Sonarpur, Kalikapur, South 24 Pgs	6	GOVT	PHC	
68	Kantamari PHC	Kultali, Kantamari, South 24 PGS	6	GOVT	PHC	
69	Kuchitala (Sarengabad) PHC	Canning - III, Kuchitalahat South 24PGS	6	GOVT	PHC	
70	Langalberia PHC	Sonarpur, Dakshin Gobindapur, South 24 Pgs	6	GOVT	PHC	
71	Mayachouri PHC	Joynagar - II, Mayachouri, South 24 Pgs	6	GOVT	PHC	
72	Meukhali PHC	Bishnupur - II, Charshyamdass, South 24 Pgs	6	GOVT	PHC	
73	Momrejgar (Goalgeria) PHC	Joynagar - I, Sri Krishna, South 24 Pgs	6	GOVT	PHC	
74	Nalgara PHC	Joynagar - II, Sonathikri, South 24 Pgs	6	GOVT	PHC	
75	Narayanpur PHC	Namkhana, Narayanpur, South 24 Pgs	6	GOVT	PHC	
76	Naya Pukuria PHC	Joynagar - II, Naya Pukuria, South 24 Pgs	6	GOVT	PHC	
77	Panchgachia PHC	Baruipur, Gocharan, South 24 Pgs	6	GOVT	PHC	
78	Purandarpur PHC	Mathurapur - II, Pukurhat, South 24 Pgs	6	GOVT	PHC	
79	Ramkrishnapur PHC	Mandirbajar, Ramkrishnapur, South 24 Pgs	6	GOVT	PHC	
80	Tona PHC	Bhangore - II, Polarhat via MachibhSouth 24 Pgs	6	GOVT	PHC	
81	Dakshin Radhanagar PHC	Gosaba, Dhalarhat, South 24 PGS	2	GOVT	PHC	
82	Fresherganj PHC	Namkhana, Fresherganj, South 24 Pgs	2	GOVT	PHC	
83	Gandia Raghunathpur PHC	Diamond Harbour - II, Raghunathpur, South 24 Pgs	2	GOVT	PHC	
84	Gangasagar PHC	Sagar, Gangasagar, South 24 PGS	2	GOVT	PHC	
85	Ghutiary Sharif PHC	Canning - I, Ghutiary SharifSouth 24PGS	2	GOVT	PHC	
86	Haridevpur PHC	Thakurpukur - Metiaburuj, Paschim Putiary, South 24 Pgs	2	GOVT	PHC	
87	Jamalpur PHC	Budgebudge - I, Jamalpur, South 24 Pgs	2	GOVT	PHC	
88	Jamtalahat PHC	Kulpi, Jamtalahat, South 24 Pgs	2	GOVT	PHC	
89	Kanthal Beria PHC	Basanti, Kanthal Beria PHC, South 24 PGS	2	GOVT	PHC	
90	Maharajganj PHC	Namkhana, Maharajganj, South 24 Pgs	2	GOVT	PHC	
91	Mahendragunj PHC	Sagar, Mahendragunj, South 24 PGS	2	GOVT	PHC	
92	Maheshpur PHC	Basanti, Bharadwajpur, South 24 PGS	2	GOVT	PHC	
93	Maipith PHC	Kultali, Maipith, South 24 PGS	2	GOVT	PHC	
94	Muriganga PHC	Sagar, Muriganga, South 24 PGS	2	GOVT	PHC	
95	Paschim Bhawanipur PHC	Diamond Harbour - II, Mukundapur, South 24 Pgs	2	GOVT	PHC	

DISTRICT WISE LIST OF BEDDED HCUs IN WEST BENGAL

INVENTORY: ANNEXURE - I

Sl. No	Name of the Units.	Address	Current Bed	Organisation	Category General	Category Special
96	Raghunathpur (Masat) PHC	Diamond Harbour - I, Raghunathpur, South 24 Pgs	2	GOVT	PHC	
97	Ramchandranagar PHC	Kakdwip, Ramchandranagar, South 24 Pgs	2	GOVT	PHC	
98	A. T. Dhar Memorial Hospital	Budgebudge, South 24 Pgs	28	GOVT	MUNI	
99	Budgebudge Municipal Hospital	Budgebudge, South 24 Pgs	28	GOVT	MUNI	
100	Joynagar - Majilpur Maternity Home	Joynagar - Majilpur, South 24 Pgs	10	GOVT	MUNI	MNTY
101	Joynagar Hospital	Joynagar - Majilpur, South 24 Pgs	2	GOVT	MUNI	
102	Pranati Bhattejee Smriti Matri Sadan,	Rath Tala, 24 Pgs (S)	20	GOVT	MUNI	MNTY
103	Kalikapur Bidhannagar Municipality Hospital	Kalikapur, Sonarpur, Dist. South 24 Parganas	10	GOVT	MUNI	
104	Maternity & Child Welfare Cent.& Urban Welfare Cent.	Joynagar, South - 24 Pgs - 743337	10	GOVT	MUNI	MNTY
105	Maheshtala Maternity (Maheshtala Municipality)	Maheshtala, South 24 Pgs	4	GOVT	MUNI	MNTY
106	E. S. I. Hospital, Budgebudge	Budgebudge, South 24 Pgs	300	GOVT	SGL	
107	E. S. I. Hospital & Occupational Disease Center	D. H. Road, P. O. - Joka, South 24 Pgs	210	GOVT	CGL	
108	Sarkerpool Mental Hospital	Mahestala, Sarkerpool, South 24 Pgs	150	PVT	N.HOME	
109	Jubilant First Trust Health Care Ltd.	78, Jessor Road, Dist North 24 Pgs, PIN -700 127	120	PVT	N.HOME	
110	Yogiraj Shyamacharan Sanatan Mission	Pukurberia, Kakdwip, South 24 Parganas	95	PVT	N.HOME	
111	Kasturi Medical Research Center (P) Ltd.	3A Bus Stand, D. H. Road, Thakurpukur, Joka, South 24 Pgs.	90	PVT	N.HOME	
112	Charitable SBD Diagnostic Center & N. Home	B. B. T. Road, Chandan Nagar, P.O. & P.S.: Maheshtala, Kolkata - 700 141	50	PVT	N.HOME	
113	Hindusthan Health Point Pvt Ltd.	2406 Goria Main Rd. Hindusthan More, Kol - 84	50	PVT	N.HOME	
114	Life Line Hospital	N.S.C. Bose Road, Kamalgazi, South 24 Parganas.	50	PVT	N.HOME	
115	Santiniketan Nursing Home	Shahjahan Rd., Baruipur, Kol - 144	30	PVT	N.HOME	
116	Basanti Devi Nursing Home	Garia Station Rd. Kol - 84	25	PVT	N.HOME	
117	Mass Education Women & Child Care Hospital & Poly Clinic	Dakshin Kumarkhali, Sonarpur South 24 Pgs.	25	PVT	N.HOME	
118	Netaji Subhas General & Maternity Hospital	P.S.: Akra, Maheshtala, P.O.: Jagannath Nagar, South 24 Parganas	25	PVT	N.HOME	
119	Restractive Clinic	Station Road, Kol - 110	25	PVT	N.HOME	
120	Baruipur Globe Nursing Home & Society	Sahagung Rd., Baruipur, South 24 Parganas	20	PVT	N.HOME	
121	Caribon Nursing home	Joydevpur, Dari Krishna Nagar, D. Harbour	20	PVT	N.HOME	
122	Diamond Harbour Maternity Home	Diamond Harbour, South 24 Pgs	20	PVT	N.HOME	
123	Dr. Das Nursing Home	New Town, D. Harbour, South 24 Pgs.	20	PVT	N.HOME	
124	Globe Nursing Home & Society	Sahajahan Road, Baruipur	20	PVT	N.HOME	
125	M. P. Birla Foundation Medical Society Unit, Birla pur Hospital	Birlapur, Budgebudge, South 24 Pgs.	20	PVT	N.HOME	
126	Red Cross Maternity & Child Welfare Hospital	Puratan Bazar, Diamond Harbour, South 24 South 24 Pgs	20	PVT	N.HOME	
127	Searight Hospital & Welfare Society	Bakrahat Road, P.O.: Rasapunja, P.S.: Bishnupur, South 24 Pgs.	20	PVT	N.HOME	

DISTRICT WISE LIST OF BEDDED HCUs IN WEST BENGAL

INVENTORY: ANNEXURE - I

Sl. No	Name of the Units.	Address	Current Bed	Organisation	Category General	Category Special
128	The Amtala Nursing Home	Kanyanagar, South 24 Pgs.	20	PVT	N.HOME	
129	The New Life Nursing Home	Baruipur Railway gate, Kulpi Road, Baruipur	20	PVT	N.HOME	
130	Namita Biswas Memorial Eye Clinic	Station Park, Gorla, South 24 Pgs.	15	PVT	N.HOME	EYE
131	Shis Eye Care Hospital	P.O.: Bhangore, South 24 Parganas	15	PVT	N.HOME	EYE
132	Arpan Nursing Home	Fatepur, P.S.: Falta, South 24 Pgs,	15	PVT	N.HOME	
133	New Baruipur Nursing Home	Golpukur, Baruipur, South 24 Pgs.	15	PVT	N.HOME	
134	Santoshpur Nursing Home	Bidhangarh, Budge Budge, Kol - 66	15	PVT	N.HOME	
135	Sarada Seva Pratisthan	Amtala, Kanna Nagar, Bishnupur, South 24 Pgs.	15	PVT	N.HOME	
136	Shibrampur B. C. Halder Memo. Hosp.	Biren Roy Rd. Jote Sibrampur, Maheshtala South 24 Pgs	15	PVT	N.HOME	
137	Temple Nursing Home	125, N. S. Road, Rajpur, Kalitala, South 24 Pgs.	15	PVT	N.HOME	
138	Vision Welfare Society	Station Park, Gorla, Kol - 84,	15	PVT	N.HOME	
139	Grasin Rotary Eye Hosp.	Budgebudge	10	PVT	N.HOME	EYE
140	Basanti Nursing Home	Vill. & P.O.: Bassanti, South 24 Parganas	10	PVT	N.HOME	
141	Dakshinanchal Swastha Sadan	310/2, N. S. Road, Banerjee Para More, Joynagar	10	PVT	N.HOME	
142	Dev Dutta Medical Res. Cent.	Vivekananda Pally, Sonarpur	10	PVT	N.HOME	
143	G. M. Bhansali Nursing Home	Uttar Rajapur, Kulpi	10	PVT	N.HOME	
144	Gayland Nursing Home	Joka, South 24 Pgs.	10	PVT	N.HOME	
145	Green View Nursing & Maternity Home	Amtala, Baruipur Road, P.O.: Kanyanagar, Dist. South 24 Pgs.	10	PVT	N.HOME	
146	Health Care Complex	5B, Colony, Ghatakpur, South 24 Parganas	10	PVT	N.HOME	
147	Maa Durga Nursing Home	P.O. & P.S.: Kulpi, South 24 Parganas	10	PVT	N.HOME	
148	Nursing Home Palace	Vill.: Kirtonkhola, P.O.: Bakhrahat, P.S.: nupur, South 24 Pgs.	10	PVT	N.HOME	
149	Purbasha Nursing home	Rasapunja, Biswanupur	10	PVT	N.HOME	
150	Seva Bhaban Nursing Home	Kakdwip, South 24 Parganas	10	PVT	N.HOME	
151	Seva Kendra Nursing Home	Dakghar, Maheshtala, South 24 Parganas	10	PVT	N.HOME	
152	Seva Tirtha Nursing Home	Sahajahan Road, Baruipur, South 24 Parganas	10	PVT	N.HOME	
153	Shankar Nursing Home	118, B. C. Sarani, Konapara, P.O.: Joynagar-Majilpur, South 24 Pgs	10	PVT	N.HOME	
154	Spandan Medicare	16, N.S. Road, Kodalia, Battala, Rajpur Sonarpur Municipality, S	10	PVT	N.HOME	
155	Uttaran Nursing Home	Pailan Hat, D. H. Road, P.S.: Bishnupur, Kolkata - 104, South 24 Parganas	10	PVT	N.HOME	
156	Satyanani Memorial Nursing Home	Ghasira More, P.O. & P.S.: Sonarpur, Kol - 150, South 24 Pgs.	9	PVT	N.HOME	
157	Care Nursing Home (Gold Care Co. (P) Ltd.)	49/1Garia Station Rd., Kol - 84, P.S. Sonarpur, South 24 Parganas	8	PVT	N.HOME	
158	Life Time Nursing Home	Vill.: Mamudpur, P.O.: Rajarpur, P.S.: Falta, South 24 Parganas	8	PVT	N.HOME	
159	Sri Sarada Seba Pratisthan	Mayanagore, Maheshtala, South 24 Parganas	8	PVT	N.HOME	

DISTRICT WISE LIST OF BEDDED HCUs IN WEST BENGAL

INVENTORY: ANNEXURE - I

Sl. No	Name of the Units.	Address	Current Bed	Organisation	Category General	Category Special
160	Sundarban Diagnostic Clinic & Nursing home	Kakdwip, South 24 Pgs.	8	PVT	N.HOME	
161	Baruipur Eye Hospital & Micro Surgery Res. Cent.	Brickfield Road, Subudhipur, Baruipur, South 24 Parganas	6	PVT	N.HOME	EYE
162	Sundarban Rotary Netralaya & Micro Surgery Foundation	Vill.: Khari Kashinagar, P.O.: Kashinagar, P.S.: Raidighi, South 24 Parganas	6	PVT	N.HOME	EYE
163	Arogya Bhawan Nursing Home & Maternity Home	Vill.: Ghatakpur, P.O.: B Gobindapur, P.S.: Bhangar, South 24 Parganas	6	PVT	N.HOME	
164	Arogya Niketan Nursing Home	Vill.: Punya, P.O.: Sahararhat, South 24 Parganas	6	PVT	N.HOME	
165	Bharat Nursing Home	Dhamua Station Rd. Dhamua, Mograhat, South 24 Parganas	6	PVT	N.HOME	
166	Blue View Nursing Home	Madarat Masjid Para, Madarat, Baruipur, South 24 parganas	6	PVT	N.HOME	
167	Debangan Nursing Home	Vill.: Narayantitala, P.O.: Gocharan, P.S.: Jaynagar, South 24 Parganas	6	PVT	N.HOME	
168	Deepanjan Nursing Home	Vill.: Matla - 1, P.O. & P.S.: Canning, South 24 Parganas	6	PVT	N.HOME	
169	Joyti Nursing Home	Vill.: Srirampur, P.O.: Belsingha, P.S.: Falta, South 24 Parganas	6	PVT	N.HOME	
170	Matri Sadan Nursing Home	Vill: Rathtala, Ganeshpur, P.O. & P.S.: Kakdwip, South 24 Parganas	6	PVT	N.HOME	
171	Mir Clinic & Nursing Home	Jalghata, Jhoromore, P.O.: J.S. Bad, P.S.: Canning, South 24 Parganas	6	PVT	N.HOME	
172	Nibedita Nursing Home	Dakshin Barasat, South 24 Parganas	6	PVT	N.HOME	
173	Nutan Jiban Nursing Home	Gorkhara, Ghosepara, Sonarpur, Kolkata - 150, South 24 Parganas	6	PVT	N.HOME	
174	Sarada Matri Mangal Seva Kendra	Vill.: Sriharpur, P.O.: Gurudaspur, P.S.: Pathar Pratima, South 24 Parganas	6	PVT	N.HOME	
175	Sundarban Social Development Centre	Vill.: Pollerhat, P.O.: Bijoygarh, South 24 Parganas	6	PVT	N.HOME	
176	Surjapur Adarsha Nursing Home	Vill. & P.O.: Surjapurhat, P.S.: Baruipur, South 24 Parganas	6	PVT	N.HOME	
177	Kaliprasad Gupta Rotary Netra Niketan	Canning Town, South 24 Pgs.	5	PVT	N.HOME	EYE
178	Adhir Kumar Manna Nursing Home & Diagnostic Center	C/o. Manna Medical Center, Station Road, P.O.: & P.S.: Diamond Harbour,	5	PVT	N.HOME	
179	Al Amin Medical Centre	20 Mitragunj Rd., Joynagar-Mozilpur, South 24 Parganas	5	PVT	N.HOME	
180	Amtala Central Nursing Home	Nibaran Dutta Rd. Amtala, Ramkrishnapur (N), Bishnupur - II, South 24 Pgs.	5	PVT	N.HOME	
181	Arogya Nursing Home	Kakdwip Rathtala, South 24 Pgs.	5	PVT	N.HOME	
182	Arogyabhawan Nursing Home & Maternity	Ghatakpukur, South 24 Parganas	5	PVT	N.HOME	
183	Asha Nursing Home	Sukdevpur, Nurpur, 24 Pgs (S)	5	PVT	N.HOME	
184	Baidyas Nursing Home	Sahararhat, Falta	5	PVT	N.HOME	
185	Baruipur Nursing Home & Maternity	Madarat Station Rd. Baruipur, South 24 Pgs.	5	PVT	N.HOME	
186	Central Nursing Home	D. Harbour, Madhabpur	5	PVT	N.HOME	
187	Central Nursing Home & Diagnostic Center	D. H. Road , (Back Side Police Station), South 24 Pgs - 743331	5	PVT	N.HOME	
188	Cure Clinic Nursing Home	29, S. N. Banerjee Rd, Budgebudge, South 24 Parganas	5	PVT	N.HOME	
189	Dakshin Barasat Nursing Home	Dakshin Barasat, Kalikapur, South 24 Pgs.	5	PVT	N.HOME	
190	Deshbandhu Nursing Home	Parulia More, Diamond Harbour, South 24 Parganas	5	PVT	N.HOME	
191	Dhanwantari Nursing Home	13/1, Dhanwantari Road, Joynagar Rath Tala, South 24 Parganas	5	PVT	N.HOME	

DISTRICT WISE LIST OF BEDDED HCUs IN WEST BENGAL

INVENTORY: ANNEXURE - I

Sl. No	Name of the Units.	Address	Current Bed	Organisation	Category General	Category Special
192	Diamond Nursing Home Poly Clinic	Kapathat, New Town, D.Harbour, South 24 Pgs.	5	PVT	N.HOME	
193	Diamond Park Nursing Home	P - 13, Diamond Park Joka	5	PVT	N.HOME	
194	Dipanjan Nursing Home	Canning Bus Stand	5	PVT	N.HOME	
195	Doctor`s Nursing Home	New Town, P.O. & P.S.: D. Harbour, South 24 Pgs.	5	PVT	N.HOME	
196	Dr. Monindra Netralok	Narayanpur, Namkhana, South 24 Parganas	5	PVT	N.HOME	
197	Dr. S. Haque Nursing Home	Padma Pukur Baruipur	5	PVT	N.HOME	
198	Emilie Nursing Home	Kakdwip, Rathtala	5	PVT	N.HOME	
199	Florence Nursing Home	Chandideul, Falta	5	PVT	N.HOME	
200	Greenland Nursing Home	Bijoygunj, Mandirbazar, South 24 Pgs	5	PVT	N.HOME	
201	Greenview Health Clinic	P -9, Nabapally , Dighirpar, Canning Town	5	PVT	N.HOME	
202	Gulabi Raj Shyamal Memorial Rotary Eye Hospital	71, 71, M. G. Road, Budge Budge, South 24 Parganas	5	PVT	N.HOME	
203	Happy Health Home	Gebberia,Dosotina,Bishnupur	5	PVT	N.HOME	
204	Jamiruddin Nursing Home	Roy Nagar, P.O. & P.S.: D. Harbour, South 24 Pgs	5	PVT	N.HOME	
205	Kalpataru Nursing Home	Bathberia, P.S.: Falta, South 24 Parganas	5	PVT	N.HOME	
206	Mandal Nursing Home	Raidighi, Mathurapur - II, South 24 Pgs.	5	PVT	N.HOME	
207	Mariyam Nursing Home	Joydevpur, P.O.: Dari Krishna Nagar, P.S.: D. Harbour, South 24 Parganas	5	PVT	N.HOME	
208	Matri Bhawan Nursing Home	27/23 Basudev Bhattejee Road , Kariapara, Joynagar Mojilpur	5	PVT	N.HOME	
209	Medical Nursing Home	New Town , Dimond Harbour, 24 Pgs (S)	5	PVT	N.HOME	
210	Mondal Nursing Home	Sanjua, Bakhrahat, South 24 Pgs.	5	PVT	N.HOME	
211	Mother Land Nursing Home	Vill.: Diagambarpur, P. S.: Pathar Pratima, South 24 Pgs	5	PVT	N.HOME	
212	Mothers Home	Kakdwip, South 24 Pgs	5	PVT	N.HOME	
213	Nagendra Memorial Nursing Home	Vill & P.O: Fatepur, South 24 Pgs.	5	PVT	N.HOME	
214	Namita Nursing Home & Diag. Cent.	Baruipur, South 24 Pgs.	5	PVT	N.HOME	
215	Nebadita Nursing Home	P.O.: Dakshin Barasat, P.S.: Joynagar, South 24 Pgs.	5	PVT	N.HOME	
216	Nenus Nursing Home	Champahati, South 24 Pgs	5	PVT	N.HOME	
217	New Devine Nursing Home	Champahati	5	PVT	N.HOME	
218	New Life Nursing Home	Vill. & P.O.: Gobindarampur, P.S.: Kakdwip, South 24 Parganas	5	PVT	N.HOME	
219	New Life Nursing Home	New Town, Diamond Harbour, South24 Pgs.	5	PVT	N.HOME	
220	New Ma Sarada Nursing Home	Sirakole, Sherpur Road, Usthi	5	PVT	N.HOME	
221	New Medinova Nursing Home	Kakdwip, Rathtala	5	PVT	N.HOME	
222	New Popular Nursing Home	Vill.: Jaggnathpur, P.O. Sahararhat, P.S. Falta, South 24 Pgs.	5	PVT	N.HOME	
223	New Suraksha Nursing Home	Sahararhat More, Jannathpur, P.S. Falta, South 24 Pgs - 743504	5	PVT	N.HOME	

DISTRICT WISE LIST OF BEDDED HCUs IN WEST BENGAL

INVENTORY: ANNEXURE - I

Sl. No	Name of the Units.	Address	Current Bed	Organisation	Category General	Category Special
224	New Women's Nursing Home	P.O. & P.S.: Kakdwip, South 24 Parganas	5	PVT	N.HOME	
225	Nightingale Nursing Home	NewTown P.O. & P.S.: D. Harbour, South 24 Parganas	5	PVT	N.HOME	
226	Niramoy Nursing Home	Usti, South 24 Parganas	5	PVT	N.HOME	
227	Orient Nursing Home	Banikpur, Mahitala, Magrahat, P.S. : Magrahat	5	PVT	N.HOME	
228	P. M. Nursing Home	Sangrampur, Masat, South 24 Pgs.	5	PVT	N.HOME	
229	Radha Krishna Sebayatan	Mandir Bazar, South 24 Pgs	5	PVT	N.HOME	
230	Rajarhat Nursing Home	Ajodhya Nagar, Sirakol, Usthi	5	PVT	N.HOME	
231	Ramkrishna Sarada Seva Sadan	Bakrahat, P.S.: Bishnupur, South 24 Parganas	5	PVT	N.HOME	
232	Sagore Nursing Home	Girls School Road, D. Harbour, South 24 PGS.	5	PVT	N.HOME	
233	Samadhan Nursing Home	Vill.: Rajarhat, P.O.: Sirakol, P.S.: Usthi, South 24 Parganas	5	PVT	N.HOME	
234	Samparka Nursing Home	Vill.: Uttar Kalikapur, P.O.: Dakshin Barasat, Joynagar, South 24 Parganas	5	PVT	N.HOME	
235	Samrat Nursing Home	New Town, P.O. & P.S.: D. Harbour, South 24 Pgs.	5	PVT	N.HOME	
236	Sarada Seva Sadan Nursing Home & Maternity	100, B. K. L, Bhatteejee Rd. Joynagar Mojilpur	5	PVT	N.HOME	
237	Sathi Nursing Home	Newtown Diamond Harbour	5	PVT	N.HOME	
238	Satya Rani Memorial Nursing home	Sonarpur, Ghasiara More	5	PVT	N.HOME	
239	Satyajit Nursing Home	5, Sarat Dutta Road, Radha Ballavetala, Joynagar,	5	PVT	N.HOME	
240	Seba Nursing Home	New Town , D. Harbour	5	PVT	N.HOME	
241	Sebayan Nursing Home	Amtala, Kanna Nagar, Bishnupur, South 24 Pgs.	5	PVT	N.HOME	
242	Sharif Seva Sadan	Dudh Kalmi Bazar (Munsir Poll Bazar), South 24 Parganas	5	PVT	N.HOME	
243	Shibrampur Nursing Home	Jote Shibrampur, Maheshtala, South 24 Parganas	5	PVT	N.HOME	
244	South 24 Pgs Clinic & Res. Center	Water Tank Rd, Roy Nagar, D. Harbour, South 24 Pgs.	5	PVT	N.HOME	
245	South Bengal Nursing Home	Kapathat, D. Harbour	5	PVT	N.HOME	
246	South Star Nursing Home	Sonarpur Bazar, South 24 Pgs	5	PVT	N.HOME	
247	Southern Nursing Home	Namkhana, South 24 Pgs.	5	PVT	N.HOME	
248	Sree Guru Nursing Home	Biren Roy Rd. West Sibrampur, Sarsuna, South 24 Pgs	5	PVT	N.HOME	
249	Star Nursing Home	Vill.: Suri, P.O.: Agarpara, P.O.: Nodakhali, South 24 Parganas	5	PVT	N.HOME	
250	Sudhir Nursing Home	Vill.: Uttar Kalikapur (Dakshin Barasat Bazar), P.O.: Dakshin Barasat,	5	PVT	N.HOME	
251	Sunview Nursing Home	Ghatakukur Bazar, Bhangur	5	PVT	N.HOME	
252	The Joynagar Nursing Home	Tilipara, Joynagar - Mojilpur	5	PVT	N.HOME	
253	The Sahararhat Nursing Home	Belsingha, Sahararhat, Falta	5	PVT	N.HOME	
254	The Sushil Maternity & F. P. Center	N. D. Road, Kanyanagar Colony, P. S.: Barisha, South 24 Pgs.	5	PVT	N.HOME	
255	Venus Nursing Home	P.O.: Champahati, P.S.: Baruiapur, South 24 Pgs.	5	PVT	N.HOME	
256	Womens Care	Vill.: Rath Tala, P.O. Kakdwip, South 24 Pgs.	5	PVT	N.HOME	
257	Mother Teresa Nursing Home	Vill-Madhabnagar, P.O. M/Durgagobindapur, P.S. Patharpratima,	5	PVT	N.HOME	

DISTRICT WISE LIST OF BEDDED HCUs IN WEST BENGAL

INVENTORY: ANNEXURE - I

Sl. No	Name of the Units.	Address	Current Bed	Organisation	Category General	Category Special
258	Barasat Eye Hosp. & Micro Surgery Res, Cent.	Station Rd. Dakshin Barasat, South 24 Pgs	4	PVT	N.HOME	EYE
259	Upasana Eye Foundation & Medical Centre	Uttar Kalikapur, Dakshin Barasat	4	PVT	N.HOME	EYE
260	Arogya Nursing Home	8/1, Deshbandhu Chittaranjan Road, Budge Budge, South 24 Parganas	4	PVT	N.HOME	
261	Arogyanilay	Deshbandhu C. R. Rd. Budgebudge, South 24 Pgs.	4	PVT	N.HOME	
262	Central Nursing Home	Uttar Ramkrishnapur, P.O.: Sukhdebpur, Thana - Bishnupur, South 24 Pgs	4	PVT	N.HOME	
263	Chorial Nursing Home	4/1, R. N. Tagore Road, Budge Budge	4	PVT	N.HOME	
264	Dr. Rahim Memorial Nursing Home	Surjapur Hat , Baruipur	4	PVT	N.HOME	
265	Favourite Nursing Home	Kulpi Road, Purutan Bazar, Baruipur, South 24 Pgs.	4	PVT	N.HOME	
266	Geeta Medical Center Nursing Home	Station Rd. Sahebpur, Sonarpur, Kol - 150	4	PVT	N.HOME	
267	Jeevan Deep Nursing Home	Gabberia, P.O.: Dosotina, P.S.: Bishnupur, South 24 Parganas	4	PVT	N.HOME	
268	Jeevantari Nursing Home	Kapat Hat, D. H. Road, South 24 Parganas	4	PVT	N.HOME	
269	Life Care Nursing Home	Sugyapurhat, Baruipur, South 24 Parganas	4	PVT	N.HOME	
270	Life Care Nursing Home	Dhopaghachi, Kundrali, Baruipur	4	PVT	N.HOME	
271	M. K. Nursing Home	Dastipur, Falta, South 24 Pgs.	4	PVT	N.HOME	
272	Padma Nursing Home	Bangooghly, Sonarpur	4	PVT	N.HOME	
273	Ritika Nursing Home	Natun Para, Baruipur (S), South 24 Pgs.	4	PVT	N.HOME	
274	Ser Ali Nursing Home	Raghabpur, Nepalgunj, South 24 Pgs.	4	PVT	N.HOME	
275	Sinju Nursing Home	Baruipur Puratan Bazar, Baruipur, South 24 Pgs.	4	PVT	N.HOME	
276	Suraksha Nursing Home	Mouzapur, Mandir Bazar, South 24 Parganas	4	PVT	N.HOME	
277	B. M. Nursing Home	Harindanga Bazar, P.O.: Chabaria, P.S.: Falta, South 24 Pgs	3	PVT	N.HOME	
278	Iland Nursing Home	Rudranagar Sagar, South 24 Pgs.	3	PVT	N.HOME	
279	Maa Saradamoyee Seba Kendra	105, N.S. C. Bose Road, Haraharitala, P.O.: Harinavi, P.S.; Sonarpur,	3	PVT	N.HOME	
280	Moukhali Nursing Home	Moukhali, Charashamdas, South 24 Pgs.	3	PVT	N.HOME	
281	Seva Sadhan Nursing Home	Mojilpur Kariapara, Joynagar, Majilpur, South 24 Pgs	3	PVT	N.HOME	
282	Sonali Nursing Home	5 Floom Kasinagar, Madhabnagar, Kakdwip, South 24 Pgs.	3	PVT	N.HOME	
283	The Bakhrahat Surgical Nursing Home	Kirtankhola, Bakhrahat	3	PVT	N.HOME	
284	Tilottama Maternity & Nursing Home	Nangi, Batanagar, South 24 Pgs	3	PVT	N.HOME	
285	Dakghar Nursing Home	Jalkhura, P.O.: Maheshatala, South 24 Pgs.	2	PVT	N.HOME	
286	Happy Home Nursing Home	Ghotakpukur, Bhangore	2	PVT	N.HOME	
287	Karanjali Nursing Home	Karanjali. Kulpi, South 24 Pgs.	2	PVT	N.HOME	
288	South Point Nursing Home	Natun Hat, P.O.- Baral, P. S. - Sonarpur South 24 Pgs.	2	PVT	N.HOME	
		TOTAL NUMBER OF BEDS IN SOUTH 24 PARGANAS DISTRICT:	3833			

DISTRICT WISE LIST OF BEDDED HCUs IN WEST BENGAL

INVENTORY: ANNEXURE - I

Sl. No	Name of the Units.	Address	Current Bed	Organisation	Category General	Category Special
UTTAR DINAJPUR						
1	Raiganj Dist. Hospital, Uttar Dinajpur	P.O. Raiganj, Dist. Uttar Dinajpur	168	GOVT	DH	
2	S.D. Hospital – Islampur, Uttar Dinajpur	P.O. Islampur, Uttar Dinajpur	68	GOVT	SD	
3	Karandighi Rural Hospital	Karandighi, P.O. Karandighi, Uttar Dinajpur	30	GOVT	RH	
4	Kaliaganj Block Primary Health Center	Kaliaganj, P.O. Kaliaganj, Uttar Dinajpur	60	GOVT	BPHC	
5	Hemtabad BPHC	Hemtabad, P.O. Hemtabad, Uttar Dinajpur	25	GOVT	BPHC	
6	Itahar BPHC	Itahar, P.O. Itahar, Uttar Dinajpur	25	GOVT	BPHC	
7	Chakulia BPHC	Gowalpukur – II, Gowalpukur, Uttar Dinajpur	15	GOVT	BPHC	
8	Chopra (Dalua) BPHC	Chopra, P.O. Dalua, Uttar Dinajpur	15	GOVT	BPHC	
9	Loddhan BPHC	Gowalpukur – 1, P.O. Gowalpukur, Uttar Dinajpur	15	GOVT	BPHC	
10	Islampur BPHC (Functioning from Islam S.D. Hospital)	Islampur, P.O. Ramganj, Uttar Dinajpur	6	GOVT	BPHC	
11	Bangalbari PHC	Hemtabad, P.O. Bangalbari, Uttar Dinajpur	10	GOVT	PHC	
12	Rampur PHC	Raiganj, P.O. Maharajahat, Uttar Dinajpur	10	GOVT	PHC	
13	Baharail PHC	Hemtabad, P.O. Baharail, Uttar Dinajpur	6	GOVT	PHC	
14	Bhatun PHC	Raiganj, P.O. Bholahat, Uttar Dinajpur	6	GOVT	PHC	
15	Bindole PHC	Raiganj, P.O. Bindole, Uttar Dinajpur	6	GOVT	PHC	
16	Churaman PHC	Itahar, P.O. Churaman, Uttar Dinajpur	6	GOVT	PHC	
17	Dalkhola PHC	Karandighi, P.O. Dalkhola, Uttar Dinajpur	6	GOVT	PHC	
18	Durgapur (Birghai) PHC	Raiganj, P.O. Bhupalpur, Uttar Dinajpur	6	GOVT	PHC	
19	Kanki PHC	Gowalpukur – II, P.O. Kanki, Uttar Dinajpur	6	GOVT	PHC	
20	Kunor PHC	Kaliaganj, P.O. Kunur, Uttar Dinajpur	6	GOVT	PHC	
21	Majhihar PHC	Kaliaganj, P.O. Majhihar, Uttar Dinajpur	6	GOVT	PHC	
22	Mamai PHC	Itahar, P.O. Mamai, Uttar Dinajpur	6	GOVT	PHC	
23	Marnai PHC	Itahar, P.O.: Marnai, Uttar Dinajpur	6	GOVT	PHC	
24	Sonarpur PHC	Chopra, P.O. Sonarpur, Uttar Dinajpur	6	GOVT	PHC	
25	Suran PHC	Itahar, P.O. Pariharipur, Uttar Dinajpur	6	GOVT	PHC	
26	Torial PHC	Gowalpukur – II, P.O. Torial, Uttar Dinajpur	6	GOVT	PHC	
27	Balihara PHC	Itahar, P.O. Balihara, Uttar Dinajpur	4	GOVT	PHC	
28	Lakshmipur PHC	Chopra, P.O. Lakshmipur, Uttar Dinajpur	4	GOVT	PHC	
29	Ramganja PHC	Islampur, P.O. Ramganja, Uttar Dinajpur	4	GOVT	PHC	
30	Rasakhawa PHC	Karandighi, P.O. Rasakhawa, Uttar Dinajpur	4	GOVT	PHC	
31	Sujali PHC	Islampur, P.O. Sujali, Uttar Dinajpur	4	GOVT	PHC	

DISTRICT WISE LIST OF BEDDED HCUs IN WEST BENGAL

INVENTORY: ANNEXURE - I

Sl. No	Name of the Units.	Address	Current Bed	Organisation	Category General	Category Special
32	Daspara PHC	Chopra, P.O. Daspara, Uttar Dinajpur	2	GOVT	PHC	
33	Goagaon (Limia) PHC	Gowalpukur – 1, P.O. Goagaon, Uttar Dinajpur	2	GOVT	PHC	
34	Islampur Pouro Hospital (Matri Mongal O Sishu Kalyan Kendra)	Teesta More, P.O. & P.S.: Islampur, Uttar Dinajpur	10	GOVT	MUNI	MNTY
35	Raiganj Police Hospital	Raiganj, P.O. Raiganj, Uttar Dinajpur	50	GOVT	SGP	
36	Upasana Nursing Home Pvt. Ltd.,	College Para (NH-3), Opp. Satsangha Ashram, P.O. Raiganj,	50	PVT	N.HOME	
37	Jiban Deep Nursing Home	Hospital Road, Ukilpara, P.O. Raiganj, Dist. Uttar Dinajpur	30	PVT	N.HOME	
38	Upasam Nursing Home	NH – 34, Raiganj, Dist. Uttar Dinajpur	30	PVT	N.HOME	
39	Alam Nursing Home,Tempool,	P.O. Islampur, Uttar Dinajpur	25	PVT	N.HOME	
40	Paul Clinic & Nursing Home	Ukilpara, P.O. Raiganj, Dist. Uttar Dinajpur	20	PVT	N.HOME	
41	Nibedita Seva Sadan	Ukilpara, P.O. Raiganj, Uttar Dinajpur	10	PVT	N.HOME	
42	Purabi Nursing Home	Ukilpara, P.O. Raiganj, Dist. Uttar Dinajpur	10	PVT	N.HOME	
43	Dalkhola Nursing Home	Deshbandhupara, Dalkhola, Uttar Dinajpur	6	PVT	N.HOME	
44	Dristi Pradip Eyeclinic	Ukilpara (Near Ramkrishna Asram), P.O: Raiganj, Uttar Dinajpur	5	PVT	N.HOME	EYE
45	Mitra Eye Clinic	Ukilpara, P.O. Raiganj, Dist. Uttar Dinajpur	5	PVT	N.HOME	EYE
46	Ali Nursing Home	Tinpool, P.O.: Islampur, Uttar Dinajpur	5	PVT	N.HOME	
47	Noori Nursing Home	P.O. & P.S. Islampur, Dist. Uttar Dinajpur	5	PVT	N.HOME	
48	Rahamania Nursing Home	Mela Math, Islampur, Dist. Uttar Dinajpur	5	PVT	N.HOME	
49	Krishna Mohan Seva Sadan	Mondal Para, Islampur, Uttar Dinajpur	4	PVT	N.HOME	
50	Asha Nursing Home	Tista More, Islampore, Uttar Dinajpur	3	PVT	N.HOME	
51	Life Line Nursing Home	New Market, P.O. Kanki, Uttar Dinajpur	3	PVT	N.HOME	
52	Raiganj Nursing Home	Mohanbati , P.O. Raiganj, Uttar Dinajpur	3	PVT	N.HOME	
53	Debijhora Tea Estate Hospital	Islampur, P.O. Debijhora, Uttar Dinajpur	10	PVT	Tea Est.	
		TOTAL NUMBER OF BEDS IN UTTAR DINAJPUR DISTRICT:	844			
WEST MIDNAPORE						
1	Midnapore Medical College & hospital	P.O. Midnapore, PS. Kotwali, Dist. : Midnapore (W), PIN - 721 101	561	GOVT	MCH	
2	Medinipur Homeopathic Medical College & Hospital	P. O. , Dist. : Midnapore (W)	50	GOVT	MCH	
3	S.D. Hospital – Kharagpur	Kharagpore, Medinipore (W)	276	GOVT	SD	
4	S.D. Hospital – Jhargram	Jhargram, Medinipore (W)	265	GOVT	SD	
5	S. D. Hospital – Ghatal	Kushpata, P.O. & P.S. Ghatal, Medinipore (W).	131	GOVT	SD	
6	Chandrakona Rural Hospital	Chandrakona – II, Medinipur (W)	60	GOVT	RH	
7	Garhbeta Rural Hospital	Garhbeta – I, Vill. & P.O.: Garhbeta, Medinipur (W)	60	GOVT	RH	
8	Hijli Rural Hospital	P.O. Hijli,P.S.Kharagpur (Local), Medinipur (W), PIN - 721 306	60	GOVT	RH	

DISTRICT WISE LIST OF BEDDED HCUs IN WEST BENGAL

INVENTORY: ANNEXURE - I

Sl. No	Name of the Units.	Address	Current Bed	Organisation	Category General	Category Special
9	Keshpur Rural Hospital	PO. & PS.Keshpur, Dist. Medinipur (W)	30	GOVT	RH	
10	Sabong Rural Hospital	PO. & PS. Sabong, Dist. Medinipur (W)	30	GOVT	RH	
11	Salboni Rural Hospital	PO. & PS.Salboni,Dist.Medinipur (W)	30	GOVT	RH	
12	Binpore Rural Hospital	Binpore - I, Binpore, Medinipore (W)	25	GOVT	RH	
13	Daspur Rural Hospital	Daspur – I, Daspur, Dist. Medinipur (W)	25	GOVT	RH	
14	Debra Rural Hospital	PO.Debra Bazar, PS.Debra, Dist. Medinipur (W)	25	GOVT	RH	
15	Belda BPHC	Vill. Deuli, PO & PS.Belda, Dist. Medinipur (W)	15	GOVT	BPHC	
16	Belpahari BPHC	Binpore – II, Belpahari, Medinipore (W)	15	GOVT	BPHC	
17	Bhangagarh BPHC	PO.Keshapat, PS.Sankrail, Dist.Medinipore (W)	15	GOVT	BPHC	
18	Deypara(Chandra) BPHC	PO.Chandra, PS. Kotowali, Dist. Medinipur (W)	15	GOVT	BPHC	
19	Chilkigarh BPHC	Vill & PO.Chilkigarh,PS.Jambani, Dist. Medinipore (W)	15	GOVT	BPHC	
20	Danton BPHC	PO & PS.Danton, Dist. Medinipur (W)	15	GOVT	BPHC	
21	Dwarigeria BPHC	Garbeta – III, Satbankura, Medinipore (W)	15	GOVT	BPHC	
22	Gopiballabhpur BPHC	PO. & PS. Gopiballabhpore, Dist.Medinipore (W)	15	GOVT	BPHC	
23	Keshiary BPHC	PO. & PS. Keshiary, Dist. Medinipur (W)	15	GOVT	BPHC	
24	Kewakowe BPHC	PO. & PS. Goialtore, Medinipur (W)	15	GOVT	BPHC	
25	Khandrui BPHC	PO.Turkagarh, PS. Danton,Dist. Medinipur (W)	15	GOVT	BPHC	
26	Pingla BPHC	PO. & PS. Pingla, Dist. Medinipur (W)	15	GOVT	BPHC	
27	Tapsia BPHC	Gopiballabhpore – II, Tapsia, Medinipore (W)	15	GOVT	BPHC	
28	Bagda (Mohanpur) BPHC	PO. & PS.Mohanpur, Dist. Medinipur (W)	10	GOVT	BPHC	
29	Vidyasagar (Birsingha) BPHC	Vill & PO.Birsingha, PS.Ghtal,Dist. Medinipur (W)	10	GOVT	BPHC	
30	Changual BPHC	PO.Changual,PS. Kharagpur, Dist. Medinipur (W)	10	GOVT	BPHC	
31	Kharikamathani BPHC	Kharikamathani, PS. Nayangram, Dist. Medinipore (W)	10	GOVT	BPHC	
32	Khirpai BPHC	Chandrakona – I, Khirpai, Medinipur	10	GOVT	BPHC	
33	Mohanpore BPHC	PO. Montipa Mohanpore, PS. Jhargram, Dist. Medinipore(W)	10	GOVT	BPHC	
34	Sonakhali BPHC	Daspur – II, Sonakhali, Dist. Medinipur (W)	10	GOVT	BPHC	
35	Chinchra (Amarala) PHC	Jambani, Chinchra, Medinipore (W)	10	GOVT	PHC	
36	Dudkundi PHC	Jhargram Dudkundi, Medinipore (W)	10	GOVT	PHC	
37	Kharika PHC	Sabong, Kharika, Dist. Medinipur (W)	10	GOVT	PHC	
38	Khasbar PHC	Ghatal, Khasbar, Dist. Medinipur (W)	10	GOVT	PHC	
39	Kultikri PHC	PO. Kultikri, PS. Sankrail, Dist.Medinipore (W)	10	GOVT	PHC	
40	Lalgarh PHC	Binpore – I, Lalgarh, Medinipore (W)	10	GOVT	PHC	

DISTRICT WISE LIST OF BEDDED HCUs IN WEST BENGAL

INVENTORY: ANNEXURE - I

Sl. No	Name of the Units.	Address	Current Bed	Organisation	Category General	Category Special
41	Laudiagram PHC	Jhargram, Rajbasa, Medinipore (W)	10	GOVT	PHC	
42	Mohar PHC	Sabong, Mohar, Medinipur	10	GOVT	PHC	
43	Ramjibanpur PHC	Chandrakona – I, Ramjibanpur, Dist. Medinipur (W)	10	GOVT	PHC	
44	Ramkrishnapur PHC	Chandrakona – I, Tatapara, Dist. Medinipur (W)	10	GOVT	PHC	
45	Alampore PHC	Gopiballabhore – I, Alampore, Medinipore (W)	6	GOVT	PHC	
46	Anderia PHC	Binpore – I, Anderia, Medinipore (W)	6	GOVT	PHC	
47	Baligeria PHC	Nayagram, Garradhanagar, Medinipore (W)	6	GOVT	PHC	
48	Barakalonki PHC	Narayangarh, Barakalonki, Dist. Medinipur (W)	6	GOVT	PHC	
49	Bhimpur PHC	Salboni, Bhimpur, Dist. Medinipur (W)	6	GOVT	PHC	
50	Boalia PHC	Pingla, Dhaneswarpur, Dist. Medinipur (W)	6	GOVT	PHC	
51	Chaipat PHC	Daspur – II, Chaipat, Dist. Medinipur (W)	6	GOVT	PHC	
52	Chandibila PHC	Nayagram, Chandibila, Medinipore (W)	6	GOVT	PHC	
53	Chandri PHC	Jhargram, Chandri, Medinipore (W)	6	GOVT	PHC	
54	Dgalharta PHC	Keshpur, Parsurat, Medinipur (W)	6	GOVT	PHC	
55	Dharampore PHC	Binpore – I, Dharampore, Medinipore (W)	6	GOVT	PHC	
56	Dingal PHC	Chandrakona – I, Dingal Kumargeria, Dist. Dist. Medinipur (W)	6	GOVT	PHC	
57	Ergoda (Raghunathpore) PHC	Binpore – II, Ashakanti, Medinipore (W)	6	GOVT	PHC	
58	Gatsandhya PHC	Mohanpur, gatsandhya, Dist. Dist. Medinipur (W)	6	GOVT	PHC	
59	Gokulpur PHC	Kharagpur – II, Gar Gokulpur, Dist. Dist. Medinipur (W)	6	GOVT	PHC	
60	Harma PHC	Pingla, Gobardhanpur, Dist. Dist. Medinipur (W)	6	GOVT	PHC	
61	Jalchak PHC	Pingla, Jalchak, Dist. Medinipur (W)	6	GOVT	PHC	
62	Jamiralpal PHC	Nayagram, Jamirapal, Medinipore (W)	6	GOVT	PHC	
63	Kankra shibrampur PHC	Debra, Jowada, Dist. Medinipur (W)	6	GOVT	PHC	
64	Kapagaria PHC	Jambani, Kapagaria, Medinipore (W)	6	GOVT	PHC	
65	Khukurda PHC	Vill & PO.Khukurda,PS.Daspur, Dist. Medinipur (W)	6	GOVT	PHC	
66	Mahabila (Chupka) PHC	Jhargram, Khalseuli, Medinipore	6	GOVT	PHC	
67	Manikpara PHC	Jhargram, Manikpara, Medinipore	6	GOVT	PHC	
68	Narajole PHC	Daspur – I, PO. Narajole, Dist. Medinipur (W)	6	GOVT	PHC	
69	Natuk PHC	Ghatal, Natuk, Medinipur	6	GOVT	PHC	
70	Nota PHC	Gopiballabhore – II, Dhandangri, Medinipore (W)	6	GOVT	PHC	
71	Odulchua PHC	Binpore – II, Thakuranpahari, Medinipore (W)	6	GOVT	PHC	
72	Panchkuri PHC	Medinipur, Panchkuri, Dist. Medinipur (W)	6	GOVT	PHC	

DISTRICT WISE LIST OF BEDDED HCUs IN WEST BENGAL

INVENTORY: ANNEXURE - I

Sl. No	Name of the Units.	Address	Current Bed	Organisation	Category General	Category Special
73	Paparara PHC	Kharagpur – II, Madpur, Dist. Medinipur (W)	6	GOVT	PHC	
74	Parbatipur PHC	Garbeta – I, Khakasma, Dist. Medinipur (W)	6	GOVT	PHC	
75	Pasang PHC	Debra, Pasang, Dist. Medinipur (W)	6	GOVT	PHC	
76	Pathara PHC	Sankrail, Pathara, Medinipore (W)	6	GOVT	PHC	
77	Patharjuri PHC	Keshiary, Binandapur, Dist. Medinipur (W)	6	GOVT	PHC	
78	Pathra PHC	Medinipur, Pathra, Dist. Medinipur (W)	6	GOVT	PHC	
79	Radhanagar PHC	Narayangarh, Radhanagar, Dist. Medinipur (W)	6	GOVT	PHC	
80	Ramchandrapore PHC	Gopiballabhore – II, Kharbandhi, Medinipore (W)	6	GOVT	PHC	
81	Ramgarh PHC	Binpore – I, Ramgarh, Medinipore (W)	6	GOVT	PHC	
82	Sasra PHC	Gopiballabhore – I, Sasra, Medinipore (W)	6	GOVT	PHC	
83	Silda PHC	Binpore – II, Silda, Medinipore (W)	6	GOVT	PHC	
84	Soutia PHC	Mohanpur, Soutia, Dist. Medinipur (W)	6	GOVT	PHC	
85	Tentulia (Beliatorh) PHC	Gopiballabhore - II, Jahanpore, Medinipore (W)	6	GOVT	PHC	
86	Trilochanpur PHC	Debra, Sejgaria, Dist. Medinipur (W)	6	GOVT	PHC	
87	Anandapur PHC	Keshpur, Anandapur, Dist. Medinipur (W)	4	GOVT	PHC	
88	Basanchora PHC	Chandrakona – II, Chhantraganj, Dist. Medinipur (W)	4	GOVT	PHC	
89	Bhagabantapur PHC	Chandrakona – II, Bhagabantapur, Dist. Medinipur (W)	4	GOVT	PHC	
90	Chottoatara PHC	PO.Giradaha,PS.Garbeta, Dist. Medinipur (W)	4	GOVT	PHC	
91	Godapiasal PHC	Salboni, Godapiasal, Dist. Dist. Medinipur (W)	4	GOVT	PHC	
92	Khajraberia PHC	PO. & PS. Keshiary,Dist. Medinipur (W)	4	GOVT	PHC	
93	Mahaboni PHC	Keshpur, Mahaboni, Medinipur	4	GOVT	PHC	
94	Makrampur PHC	Daspur – I, Choto Makrampur, Medinipur5	4	GOVT	PHC	
95	Mangrul PHC	Chandrakona – I, Goaldanga-Mangrul, Medinipur	4	GOVT	PHC	
96	Nayabasad PHC	Garbeta – III, Nayabasad, Medinipur	4	GOVT	PHC	
97	Nischintapur PHC	Daspur – II, Nischintapur, Dist. Medinipur (W)	4	GOVT	PHC	
98	Sabradhaneswarpur PHC	Danton – II, Khakurda, Dist. Medinipur (W)	4	GOVT	PHC	
99	Salboni (Charubala) PHC	Garbeta – II, Daltori, Dist. Medinipur (W)	4	GOVT	PHC	
100	Sandhipur PHC	Garbeta – I, Sandhipur, Dist. Medinipur (W)	4	GOVT	PHC	
101	Satyapur PHC	Debra, Maratala, Dist. Medinipur (W)	4	GOVT	PHC	
102	Amba PHC	Kharagpur – I, Suaripur, Dist. Medinipur (W)	2	GOVT	PHC	
103	Babuidanga PHC	Garbeta – III, Amlasuli, Dist. Medinipur (W)	2	GOVT	PHC	
104	Begunia PHC	Mohanpur, Begunia, Dist. Medinipur (W)	2	GOVT	PHC	

DISTRICT WISE LIST OF BEDDED HCUs IN WEST BENGAL

INVENTORY: ANNEXURE - I

Sl. No	Name of the Units.	Address	Current Bed	Organisation	Category General	Category Special
105	Bhuringi PHC	Danton – I, Bhuringi, Dist. Medinipur (W)	2	GOVT	PHC	
106	Dhansole PHC	Gopiballabhore – I, Dhansole, Medinipore (W)	2	GOVT	PHC	
107	Gansarisa PHC	Keshiary, Gansarisa, Dist. Dist. Medinipur (W)	2	GOVT	PHC	
108	Jara PHC	Chandrakona – I, Jara, Dist. Medinipur (W)	2	GOVT	PHC	
109	Khelar PHC	Kharagpur – I, Banpatu, Dist. Medinipur (W)	2	GOVT	PHC	
110	Khemasuli PHC	Kharagpur – I, Khemasuli, Dist. Medinipur (W)_	2	GOVT	PHC	
111	Laghata PHC	Binpore – I, Laghata, Medinipore (W)	2	GOVT	PHC	
112	Markrampur PHC	Narayangarh, Makrampur, Medinipur	2	GOVT	PHC	
113	Nohari PHC	Garbeta – I, Nohari, Dist. Medinipur (W)	2	GOVT	PHC	
114	Payan PHC	Danton – II, Payan, Dist. Medinipur (W)	2	GOVT	PHC	
115	Pirakata PHC	Salboni, Pirakata, Dist. Medinipur (W)	2	GOVT	PHC	
116	Rajnagar PHC	Danton – I, Deulti, Dist. Medinipur (W)	2	GOVT	PHC	
117	Sekendary PHC	Daspur – I, Sekendary, Dist. Medinipur (W)	2	GOVT	PHC	
118	Uchiipur PHC	Sabong, Uchitpur, Dist. Medinipur (W)	2	GOVT	PHC	
119	M.R. Bangur T.B. Sanatorium (Digri)	Garbeta – III, Digri, Medinipore	317	GOVT	TB	
120	Kharagpore State Medical Unit	PO. Nimpur, PS.Kharagpore, Dist. Medinipore (W)	2	GOVT	SGE	
121	Medinipore Central Jail Hospital	Kharagpore, Medinipore	130	GOVT	SGJ	
122	Kharagpore E.F.R. Hospital	Kharagpore, Salua, Medinipore (W)	75	GOVT	SGP	
123	Medinipore Police Hospital	Medinipore,	74	GOVT	SGP	
124	Special Vagrant's Home	Medinipore, Medinipore (W)	40	GOVT	SGV	
125	OPD-cum-Nursing Home. Under IPP-VIII (Extn.)	Debalpur, P.S. – KGP(T), Midnapore (W)	10	GOVT	MUNI	GEN
126	IPP VIII (Extn.) OPD Maternity Home	Debalpur, P.S. – KGP(T), Midnapore (W)	10	GOVT	MUNI	MNTY
127	S.E. Rly Divisional Hospital	Kharagpore, Medinipore (W)	340	GOVT	RLY	
128	B.C. Roy Technology Hospital	Kharagpore, Medinipore (W)	35	GOVT	CG	
129	Mint Hospital, Salboni	Salboni, Medinipore	17	GOVT	CG	
130	Spandan Advance Medicare (P) Ltd.	Rabindranagar, P.O. & P.S.: Medinipore, Dist.: Paschim Medinipore	100	PVT	N.HOME	
131	Madan Mohan Nursing Home	Deuli, P.O. & P.S.: Belda, West Midnapur	50	PVT	N.HOME	
132	Midnapur Rehabilitation Center for Children	Lalkuthi, Bidhannagar, Kotwali, Paschim Medinipore	30	PVT	N.HOME	
133	Shilabati Hospital Pvt. Ltd.,	Vill. Kushpata, P.O. Ghatala, Midnapore (W)	30	PVT	N.HOME	
134	Vidya Sagar Institute of HealthCenter for Higher Education Adv.	Rangamati, P.O. Vidyasagar University, Midnapore (W)	25	PVT	N.HOME	
135	Vidyasagar Institute of Health	Rangamati, Midnapore (W)	25	PVT	N.HOME	
136	Shivananda Nayanlok (Eye Hospital)	Math Bisnupur, P.O.: Math Bishnupur, P.S.; Debra, Paschim Medinipore	20	PVT	N.HOME	EYE

DISTRICT WISE LIST OF BEDDED HCUs IN WEST BENGAL

INVENTORY: ANNEXURE - I

Sl. No	Name of the Units.	Address	Current Bed	Organisation	Category General	Category Special
137	Bimal Arogya Niketan	Mala Noha Road, Kharagpore, Medinipore (W)	20	PVT	N.HOME	
138	Central Nursing Home	Keranitala, Medinipore Town, Medinipore (W)	20	PVT	N.HOME	
139	Divine Health Point (Maternity cum Nursing Home)	P.O.: Madpur, Kharagpur, West Midnapur	20	PVT	N.HOME	
140	Indian Red Cross Society (Paschim Midnapore Branch)	PO. & Dist. : Midnapore (W)	20	PVT	N.HOME	
141	Medinipore Nursing Home	Rabindra Nagar, Medinipore Town, Medinipore	20	PVT	N.HOME	
142	Medinipore Polyclinic Nursing Home	Nimtala Chak, Medinipore Town, Medinipore	20	PVT	N.HOME	
143	Midnapore Nursing Home	P.O. & Dist. Midnapore (W)	20	PVT	N.HOME	
144	N.K. Chatterjee Memorial Maternity cum Nursing Home	Rajabazar, Medinipore Town, Medinipore	20	PVT	N.HOME	
145	Panchanan Maternity cum Nursing Home	Kerani Tala, Medinipore Town, Medinipore (W)	20	PVT	N.HOME	
146	Roy Nursing Home	Rabindra Nagar, Medinipore Town, Medinipore (W)	20	PVT	N.HOME	
147	Spandan Diagnostic Research Centre	Rabindra Nagar, Medinipore Town, Medinipore (W)	20	PVT	N.HOME	
148	Jeebandeep Maternity & Nursing Home	Kushpata, Ghatal, Medinipore	19	PVT	N.HOME	
149	Red Cross Maternity & Child Welfare Hospital	Medinipore, Medinipore	18	PVT	N.HOME	
150	Jhargram Lions Eye Hospital	Lions Club, Jhargram, Medinipore (W)	16	PVT	N.HOME	EYE
151	Maity Nursing Home	Kushpota, Ghatal, Medinipore	15	PVT	N.HOME	
152	Med Tech	Station Road, Keranitala, Midnapore (W)	15	PVT	N.HOME	
153	Moonlight Nursing Home	Kushpata, P.O. & P.S.- Ghatal. Medinipore(W)	15	PVT	N.HOME	
154	Sabita Nursing Home	Kushpota, Ghatal, Medinipore	15	PVT	N.HOME	
155	Sanjiban Nursing Home	Kushpata, Ghatal, Medinipore (W)	15	PVT	N.HOME	
156	Marcy Nursing Home	Malancha Road, Kharagpore, Medinipore	12	PVT	N.HOME	
157	Pal Nursing Home	Kushpota, ghatal, Medinipore (W)	12	PVT	N.HOME	
158	Sree Durga Maternity cum Nursing Home	Debra, Dist. Medinipur (W)	12	PVT	N.HOME	
159	Sree Ram Diagnostic & Nursing Home	Vill.: Raghunathpur, P.O. & P.S.: Jhargram, Midnapore(W)	12	PVT	N.HOME	
160	Jhargram Leprosy Project Nursing Home	Vill. & P.S. & P.O.: Jhargram, Paschim Medinipore	10	PVT	N.HOME	LEPR
161	Ankur Child Nursing Home	P.O.: Debrabazar, P.S.: Debra, Midnapore (W)	10	PVT	N.HOME	
162	Annapurna Nursing Home	P.O. Panchberia, Midnapore (W)	10	PVT	N.HOME	
163	B.K.Sasmal Nursing Home	Kushpota, Ghatal, Medinipore (W)	10	PVT	N.HOME	
164	Bani Sebayatan Nursing Home	36, Para Kharida, P.O. Kharagpore, Medinipore (W)	10	PVT	N.HOME	
165	Bibekananda Nursing Home	Kushpata, Ghatal, Medinipore (W)	10	PVT	N.HOME	
166	Bikash Bharati Children & Orthopedic Home	Garsalbani, Jhargram, Medinipore Paschim	10	PVT	N.HOME	
167	Bimal Sishu Sadan	Kushpota, Ghatal, Medinipore	10	PVT	N.HOME	
168	Chakraborty Nursing Home	15, Arora Gate, Kharagpore, Medinipore (W)	10	PVT	N.HOME	

DISTRICT WISE LIST OF BEDDED HCUs IN WEST BENGAL

INVENTORY: ANNEXURE - I

Sl. No	Name of the Units.	Address	Current Bed	Organisation	Category General	Category Special
169	Dreamland Nursing Home	Chottakhelna, Malikgram, Medinipore Paschim	10	PVT	N.HOME	
170	Dreamland Nursing Home	Hariharpore, Baliachak, Medinipore Paschim	10	PVT	N.HOME	
171	Dreamland Nursing Home	Kushpota, Ghatal, Medinipore (W)	10	PVT	N.HOME	
172	Gandhi Mission Trust	Daspore, Ghatal, Medinipore (W)	10	PVT	N.HOME	
173	Happy Health Home	Rabindra Nagar, Medinipore Town, Medinipore (W)	10	PVT	N.HOME	
174	Indrani Nursing Home	Vill. Kushpata, P.O. Ghatal, Midnapore (W)	10	PVT	N.HOME	
175	Khargeswar Nursing Home	Inda. Kharagpore, Medinipore (W)	10	PVT	N.HOME	
176	Kshanika	Ghorathara, Jhargram, Medinipore Paschim	10	PVT	N.HOME	
177	L.C. Dani Hospital	Vill. Dihibaliharpur, P.O. Daspur, Midnapore (W)	10	PVT	N.HOME	
178	Mahamaya Nursing Home	Keranitala, Medinipore Town, Medinipore	10	PVT	N.HOME	
179	Matri Asish Nursing Home	Sultanpore, Hat Sultanpore, Medinipore Paschim	10	PVT	N.HOME	
180	Medicare Nursing Home	Daspur, Midnapore(W)	10	PVT	N.HOME	
181	New Life Nursing Home	Kushpota, Ghal, Medinipore	10	PVT	N.HOME	
182	Nightangle Nursing Home	Konnagar, Ghatal, Medinipore	10	PVT	N.HOME	
183	Niramoy Nursing Home	Kushpota, Ghatal, Medinipore	10	PVT	N.HOME	
184	Nivedita Nursing Home	Vill. Kushpata, P.O. Ghatal, Midnapore (W)	10	PVT	N.HOME	
185	Radha Rani Medda Nursing Home	Medda Villa, Kerani Tala, Medinipore (W)	10	PVT	N.HOME	
186	Raj Nursing Home & Infertility Clinic	Kausalya, Kharagpore, Medinipore (W)	10	PVT	N.HOME	
187	Raj Surgical & Diag. Clinic P. Ltd. (Nursing Home)	Kausalya, Kharagpore, Medinipore (W)	10	PVT	N.HOME	
188	Ramkrishna Seva Sadan	Cill & P.O.: Debra Bazar, P.S.: Debra, Medinipore (W)	10	PVT	N.HOME	
189	Ramkrishna Nursing Home	Goura, Daspur, Medinipore (W)	10	PVT	N.HOME	
190	Rashbehari Maternity cum Nursing Home	Subhasnagar, Medinipore Town, Medinipore (W)	10	PVT	N.HOME	
191	Sebayan Nursing Home & Maternity Centre	Daspore, Ghatal, Medinipore (W)	10	PVT	N.HOME	
192	Sishu Sadan Nursing Home	Kushputa, Ghatal, Dist. Medinipur (W)	10	PVT	N.HOME	
193	South Point Nursing Home	Kushpata, Ghatal, Medinipore (W)	10	PVT	N.HOME	
194	Sree Guru Nursing Home	Kushputa, Ghatal, Dist. Medinipur (W)	10	PVT	N.HOME	
195	Sree Ramkrishna Nursing Home	Kushpara Ghatal, Medinipore (W)	10	PVT	N.HOME	
196	Sreema Maternity cum Nursing Home	Debra, Medinipore Paschim	10	PVT	N.HOME	
197	Suchi Nursing Home	Debra, Medinipore Paschim	10	PVT	N.HOME	
198	Sunview Nursing Home	Vill.: Konnagar, P.O. & P.S.: Ghatal, Paschim Medinipore	10	PVT	N.HOME	
199	Vidyasagar Seva Sadan	Vill.: Kushpata, P.O. & P.S.: Ghatal, Paschim Medinipore	10	PVT	N.HOME	
200	Vivekananda Nursing Home	Jotghamashyana, Ghatal, Medinipore (W)	10	PVT	N.HOME	

DISTRICT WISE LIST OF BEDDED HCUs IN WEST BENGAL

INVENTORY: ANNEXURE - I

Sl. No	Name of the Units.	Address	Current Bed	Organisation	Category General	Category Special
201	Bidhan Seva Sadan	Kushpota, Ghatal, Medinipore (W)	8	PVT	N.HOME	
202	Jogendra Memorial Nursing Home	Raghunathpore, Jhargram, Medinipore Paschim	8	PVT	N.HOME	
203	Maa Sitala Poly Clinic & Nursing Home	Puratan Bazar, P.O.: Kharagpur, P.S.: Kharagpur Town. West Medinipore	8	PVT	N.HOME	
204	Raj Lakshmi Nursing Home	Sonamui, P.O.: Goura, P.S.: Daspur, West Midnapur	8	PVT	N.HOME	
205	Salban Clinic (Nursing Home)	Power House Road, Jhargram, Medinipore Paschim	8	PVT	N.HOME	
206	Santiniketan Nursing Home	Dharampore, Gatal, Medinipore (W)	8	PVT	N.HOME	
207	Daspur Woodland Nursing Home	Daspur, Ghatal, Medinipore (W)	6	PVT	N.HOME	
208	Kiageria Gramin Sasthya Kalyan Kendra	Kiageria, Chandrakona, Midnapore(W)	6	PVT	N.HOME	
209	Life Care Nursing Home cum Poly Clinic	Vill. Basudevpur, P.O. Sankarpur, Midnapore (W)	6	PVT	N.HOME	
210	Ma Sarada Nursing Home	Jhalda, Medinipore	6	PVT	N.HOME	
211	Mother Nursing Home	Gabindanagar, chanchua, Ghatal, Medinipore	6	PVT	N.HOME	
212	Nivedita Nursing Home	Vill. & P.O.: Madpur, P.S.: Kharagpur, Paschim Medinipore	6	PVT	N.HOME	
213	Sonali Nursing Home	Balipata, Narajole, Medinipore (W)	6	PVT	N.HOME	
214	Swarupananda Seva Sadan	Vill. & P.O. Keshiary, Midnapore (W)	6	PVT	N.HOME	
215	Swasti Nursing Home	GE - I, Golebazar (Janata market), P.O. & P.S.: Kharagpur, W Medinipore	6	PVT	N.HOME	
216	Swasti Nursing Home	Kolay Bazar, Kharagpore, Medinipore Paschim	6	PVT	N.HOME	
217	Tara Maa Clinic	Bishnupur, Debra, Midnapore (W)	6	PVT	N.HOME	
218	Medinipur Eye Bank & Eye Care Unit	P.O. Hijli Co-operative, KGP – 721305, Medinipur	5	PVT	N.HOME	EYE
219	P. C. R. Memorial Lions Eye Clinic	Kushpota, ghatal, Medinipore (W)	5	PVT	N.HOME	EYE
220	Shree Shree Sarada Ashram, Sevayatan Homeo & Eye	Ballavpur (Barabazar), P. O. Midnapore, Midnapore (W)	5	PVT	N.HOME	EYE
221	Amardeep Nursing Home	Chandrakona, Medinipore (W)	5	PVT	N.HOME	
222	Amiya Maternity cum Nursing Home	DVC Market, Mayapur, KGP – 6, Midnapore (W)	5	PVT	N.HOME	
223	Arogya Niketan	Shyamsundarpore, Daspore, Medinipore (W)	5	PVT	N.HOME	
224	Asirbad Maternity cum Nursing Home	Bhabanipore, Dantan, Medinipore Paschim	5	PVT	N.HOME	
225	Barik Nursing Home	Latumiya, Sabang, Medinipore (W)	5	PVT	N.HOME	
226	Bhangagarh Maternity Nursing Home	Bhangagarh, P.O. Keshiapata, Jhargram, Medinipore Paschim	5	PVT	N.HOME	
227	Child & Social Welfare Society	Markandachak, P.O.: Bishnupurbazar, P.S.: Sabong, Paschim Medinipore	5	PVT	N.HOME	
228	Damodar Nursing Home	Radhakantapore, Daspore, Medinipore (W)	5	PVT	N.HOME	
229	Damodar Nursing Home	Vill. Kushpata, P.O. Ghatal, Dist. Medinipur (W)	5	PVT	N.HOME	
230	Deshpran Nursing Home	Tatarkhan, P.O. Secondary, Midnapore (W)	5	PVT	N.HOME	
231	Disha	Kushputa, P.O. & P.S.: Ghatal, Paschim Medinipore	5	PVT	N.HOME	
232	DISHA Nursing Home	Malancha Road, P.O.: Rakhajungle, P.S.: Kharagpore, West Medinipore	5	PVT	N.HOME	

DISTRICT WISE LIST OF BEDDED HCUs IN WEST BENGAL

INVENTORY: ANNEXURE - I

Sl. No	Name of the Units.	Address	Current Bed	Organisation	Category General	Category Special
233	Ganga Nursing Home	Bidhan Nagar, Balichak, Medinipore (W)	5	PVT	N.HOME	
234	Ganga Seva Sadan,	Bidhannagar, Balichak, Medinipore Paschim	5	PVT	N.HOME	
235	Green View Nursing Home	Vill & P.O. Keshiary, Dist. Dist. Medinipur (W)	5	PVT	N.HOME	
236	Himansu Clinic	Old Contai Road, Behala, Midnapore(W)	5	PVT	N.HOME	
237	Jabeda Nursing Home	Vill.: Bishnupur, P.O.: Math Bishnupur, P.S. Debra, Midnapur (W)	5	PVT	N.HOME	
238	Jeevan Jyoti Nursing Home	Vill. Kanchanpur, P.O. & P.S. Keshiary, Midnapore (W)	5	PVT	N.HOME	
239	Jeevandeep Nursing Home	Aliganj, Medinipore Town, Medinipore (W)	5	PVT	N.HOME	
240	Jibandeeep Nursing Home	Vill.: Hariharpur, P.O.: Balichak, P.S.; Debra, Paschim Medinipore	5	PVT	N.HOME	
241	Kaushallya Nursing Home	Madhuban More (Raghunathpur), P.O. & P.S.- Jhargram, Midnapore (W)	5	PVT	N.HOME	
242	Kharagpur Nursing Home	Vill. Rangibasa, P.O. Mahishadal, Midnapore (W)	5	PVT	N.HOME	
243	Life Care Nursing Home	Preembazar, Kharagpore, Medinipore (W)	5	PVT	N.HOME	
244	Life Line Nursing Home	Gobindanagar, Chenchua, P. S. Daspur, Midnapore (W)	5	PVT	N.HOME	
245	Life Link Nursing Home	Gabinda Nagar, Ghatal, Medinipore	5	PVT	N.HOME	
246	Littles Care Unit	Choto Tangra, Kharagpur, Midnapore (W)	5	PVT	N.HOME	
247	Lokapali Seba Sadan	Vill- Parulia Po. Narayangarh Medinipur (West)	5	PVT	N.HOME	
248	Ma Nidhubala Sindhubala Seva Sadan	Dasisarisha, P.O. & P.S.: Keshiary, West Midnapore	5	PVT	N.HOME	
249	Ma Sarada Seva Sadan	P.O.: Kharikamathani, P.S.: Nayagram, West Midnapore	5	PVT	N.HOME	
250	Maa Kali Nursing Home	Vill. & P.O. Panchberia, P.S. Daspur, Midnapore	5	PVT	N.HOME	
251	Maa Sarada Nursing Home	Vill. Deuli (Chotomatkalpur), P.O. Belda, Medinipore Paschim	5	PVT	N.HOME	
252	Mahamaya Nursing Home	Debra, Medinipore Paschim	5	PVT	N.HOME	
253	Mother Care	Natundighi, Jhargram, Medinipore Paschim	5	PVT	N.HOME	
254	New Life Nursing Home	Janata Market, Kharagpore	5	PVT	N.HOME	
255	New Sun View Nursing Home	Kushputa, Ghatal, Dist. Medinipur (W)	5	PVT	N.HOME	
256	New Swarupananda Nursing Home	Khakurda, Medinipore Paschim	5	PVT	N.HOME	
257	Nirmala Nursing Home	Chandipore, P.O. Rakha Jungle, Kharagpore, Medinipore Paschim	5	PVT	N.HOME	
258	Nivedita Polyclinic Cum Nursing Home	Vill. Birsinghapur, P.O.: Mundamari, P.S.: Pingla, Paschim Medinipore	5	PVT	N.HOME	
259	Relief Nursing Home & Poly Clinic	Baliachak, Medinipore Paschim	5	PVT	N.HOME	
260	S.N. Marik Memorial cum Maternity Centre	Sipai Bazar, Medinipore Town, Medinipore (W)	5	PVT	N.HOME	
261	Sabitri Nursing Nome	Kushpata, Ghatal, Medinipore (W)	5	PVT	N.HOME	
262	Sarat Poly Clinic Cum Nursing Home	Hariharpore, Baliachak, Medinipore Paschim	5	PVT	N.HOME	
263	Sinha Polyclinic & Physiotherapy Centre Ltd.,	Vidyasagar Sarani, P.S. Kotwali, P.O. & Dist. Midnapore	5	PVT	N.HOME	
264	Trinayani Nursing Home	Vill. & P.O. Khukurdaha, P.S. Daspur, Dist. Medinipur (W)	5	PVT	N.HOME	

DISTRICT WISE LIST OF BEDDED HCUs IN WEST BENGAL

INVENTORY: ANNEXURE - I

Sl. No	Name of the Units.	Address	Current Bed	Organisation	Category General	Category Special
265	Usha Nursing Home	Malancha Road, Kharagpore, Medinipore (W)	5	PVT	N.HOME	
266	Vivekananda Netra Niramoy nursing Home	P.O. & P.S. Daspur, Midnapore(W)	5	PVT	N.HOME	
267	Anandalok Nursing Home	P.O.: Golgram, P.S.: Debra, Midnapore (W)	4	PVT	N.HOME	
268	Great India Nursing Home & Diagnostic Center	Keshpur, Midnapur (W)	4	PVT	N.HOME	
269	Kamala Nursing Home	Mathpore, Medinipore Paschim	4	PVT	N.HOME	
270	Quality Health Care Centre	Chota Tangra, P.O. KGP, Midnapore (W) PVT	4	PVT	N.HOME	
271	Ramkrishna Sevasram (Nursing Home)	Mahatabpore, Medinipore Town, Medinipore (W)	4	PVT	N.HOME	
272	Samanta Nursing Home	Golegram, P.O. & P.S.: Debra, Paschim Medinipore	4	PVT	N.HOME	
273	Sanjiban Nursing Home	Ghoradhora, P.O. Jhargram, Dist. Medinipur (W)	4	PVT	N.HOME	
274	Smrit Nursing Home	Chandrakona, Medinipore (W)	4	PVT	N.HOME	
275	Suparba Nursing Home	Kotaigarh, P.S. Narayangarh, Midnapore (W)	4	PVT	N.HOME	
276	Ghatal Fertility Center	Kushputa, Ghatal, Dist. Dist. Medinipur (W)	3	PVT	N.HOME	
277	Sri Sri Ramkrishna Sevaytan Nursing Home	P.O. Nachipur, P.O. Keshiary, Midnapore (W)	3	PVT	N.HOME	
278	Samanta Eye Care	Rabindra Nagar, P.O. & P.S.: Kotwali, West Medinipore	2	PVT	N.HOME	EYE
279	Kar Health Care Nursing Home	Vill.: Madhupur, P.O.: Hariatara, P.S.: Kharagpur, Paschim Medinipore	2	PVT	N.HOME	
280	Temathani Nursing Home	Vill. P.O. Lutunia, P.S. Sabang, Midnapore (W)	2	PVT	N.HOME	
		TOTAL NUMBER OF BEDS IN WEST MIDNAPORE DISTRICT:	4882			

INVENTORY : ANNEXURE - II

LIST OF DIAGNOSTIC CENTRES BY DISTRICT

Information Provided:

- A. Name
- B. Address
- C. Services Catered

LIST OF DIAGNOSTIC CENTRES BY DISTRICT

Sl. No	Name of the Units.	Address	Services Catered
BANKURA			
1	Abirsha Clinical Laboratory	Gogra, P.O.: Kotulpur, Bankura	Path
2	Acharya Path. Lab	Vill & PO. Onda, Dist. Bankura	Path
3	Ahmed Clinical Laboratory	Bailapara, Bishnupur	Path
4	Akui Pathological Centre	Akui School more, PO. Indus, Dist. Bankura	Path
5	Anubhab Pathology	Sonamukhi College Road, P.O.: Sonamukhi, Bankura	Path
6	Anwasha Diagnostic & Research Center	Kotulpur, Bankura	U.S.G
7	Astha Disgnostic Centre	Rampur P.O. & Dist.: Bankura	Path
8	Auto Diagnostic Centre	K.K. Bazar, Bishnupur, Bankura	Path
9	Autological Test, Bankura Speech & Hearing clinic	Kenduadihi, Bankura	Path
10	Ballav Medical Center	Ukilpara, Bishnupur, Bankura	Path
11	Bankura Diagnostic Center	Machantala, Bankura	Path
12	Bankura Neuro Center & E.E.G. Lab	Kenduadihi, Bankura	E.E.G
13	Bankura Neuro Center & E.E.G. Lab	Chandmaridanga, Bankura	E.E.G
14	Bankura Scan Center	Katjuridanga, Bankura	CT. SCAN
15	Bankura Diagnostic Center	Patpur,Zail Road Dist. Bankura	Path
16	Bankura Speech & Hearing Clinic	Kenduadihi, Bankura	Path
17	Basu Clinic	Vill & PO. Onda, Dist. Bankura	Path
18	Basuli X-Ray Clinic	Vill & P.O.: Chatna, Bankura	X-Ray
19	Beliatore X-Ray and Echo House	P.O.: Beliatore, Bankura	X-Ray
20	Care & Cure Physiotherapy Centre	Pratap Bagan, Bankura	Physiotherapy
21	Chandradoy Sales & Service (P) Ltd.	Rambhagat, Bajoria Sarani, P.O. & P.S.: Bankura	Path
22	Citiscan	Bishnupur, Bankura	U.S.G
23	Clinical Helpline	Katjuridanga, Bankura	Path
24	Cliniscan Ultrasonography Clinic	C/o. Sarada X-Ray Clinic, Balia Para, P.O.: Bishnupur, Bankura	Path
25	Comfort Zone (Physiotherapy)	260, Schooldanga Road, Dist. Bankura.	Physiotherapy
26	Diagnostic Laboratory	Vill & P.O.: Indus, Bankura	Path
27	Eastern Clinical Laboratory	Beliatore, Dist. Bankura	Path
28	Goswami Diagnostic	C/o Das Medical, Hospital Road, Ramsagar, Bankura	Path
29	Gouri Pathological Center	Hospital By-pass Road, Sonamukhi, Bankura	Path
30	Hardik Medical Diagnostric Centre Pvt. Ltd	442/3, Rabindra Sarani, P.O. & Dist.Bankura	Path
31	Health Point Clinical Path. & Diagnostic Centre	Rashikganj, Bishnupur, Dist. Bankura	Path
32	Insight Diagnostic Laboratory	Gardwarja, Bishnupur	Path
33	Insight X-Ray Clinic	Baliapara, College Road, Bishnupur, Bankura	X-Ray
34	Jupitar Path Lab	Saratpally, Khatra, Bankura	Path
35	Kaberi Polyclinic Centre	Front of Sonamukhi Municipality, Sonamukhi, Dist. Bankura	Polyclinic
36	Kotulpur Pathological Laboratory	Vill & PO. Kotulpur, Bankura	Path
37	Kulture Lab	Rajgram, Bankura	Path
38	Lakshmi Pathological Center	Indus, Bankura	Path
39	Lakshmi X-Ray & Echo Home	Chandmaridanga, Bankura	X-Ray
40	Life Line Diagnostic Center	Kenduadihi, Bankura	Path
41	Lokepali X-Ray Center	Sonamukhi Nilbari Bye Pass Road, Sonamukhi, Bankura	X-Ray

LIST OF DIAGNOSTIC CENTRES BY DISTRICT

Sl. No	Name of the Units.	Address	Services Catered
42	Lokpali X-Ray Clinic	Kenduadihi, Bankura	X-Ray
43	Lokseva X-Ray & Ultrasound Clinic	Kenduadihi, Bankura	X-Ray
44	Maa Kali Clinical Laboratory	P.O.: Salda, P.S.: Joypur, Bankura	X-Ray
45	Maa Mahamaya Path. Lab	Kenduadihi, Bankura	Path
46	Maa Sarada X-Ray Clinic	416A, Rabindra Sarani, Bankura	X-Ray
47	Maa Sarada X-Ray Clinic	Bailapara, Bishnupur, Bankura	X-Ray
48	Maakali Clinical Laboratory	Kumbhasthal, Salda, Joypur, Bankura	Path
49	Madhabi Polyclinic & Diagnostic Centre	Kenduadihi, Bankura	Polyclinic
50	Mamata Diagnostic Center	Pathakpara, Bankura	Path
51	Matribedi Samayita Jeevan Surya	Ranbalhal, Amarkanandan, Bankura	Path
52	Mediaid Diagnostic Center	Kangsabati, Dhalia Road, Khatra, Bankura	Path
53	Medicare Diagnostic Center	Joypur, Bankura	Path
54	Medi Lab Pathology Lab	Patpur, Dist. Bankura	Path
55	Mediland Pathology Center	Hospital Road, Khatra, Bankura	Path
56	Mediscan Diagnostic Centre	442/3, Rabindra Sarani, P.O. & Dist. Bankura	Path
57	Mediscrach Diagnostic Lab.	Kotulpur, Bankura	Path
58	Mou X - Ray Clinic	Court Road, PO. Khatra, Dist. Bankura.	X-Ray
59	Midland Pathological Center	Taldabra Hospital Road, Khatra, Bankura	Path
60	Mukherjee Pathological laboratory	Vill & PO. Onda, Dist. Bankura	Path
61	Mukherjee X- Ray Clinic	Vill & PO. Onda, Dist. Bankura	X-Ray
62	N.G. Diagnostic Centre	Uttar Pratap Bagan, Dist. Bankura	Path
63	Nabajiban Clinical Lab	P.O. & P.S.: Kotulpur, Bankura	Path
64	Nibedita Pathological Lab	Simapal, Bankura	Path
65	Nigamananda Medicare	Sonamukhi Nilbari Bye Pass Road, Sonamukhi, Bankura	Path
66	Nirmay Diagnostic Center	College road, Bankura	Path
67	Nivedita Pathological Laboratory	P.O.: Simlapal, Bankura	Path
68	Nityananda Arogyoniketan Diagnostic Center	Nutanganj, Dist. Bankura	Path
69	Pal U.S.G. Screening Center	Kotulpur, Bankura	U.S.G
70	Pal X-Ray Clinic	Simlapal Road, PO. Khatra, Dist. Bankura	X-Ray
71	Path Clinic	Vill. & P.O.: Kotalpur, Bankura	Path
72	Pathological Clinic	Natunchati, Bankura	Path
73	Pathological Lab.	Rabindra Sarani, PO. Khatra, Dist. Bankura	Path
74	Pranabananda Charitable Pathological Laboratory	Kenduadihi, Bankura	Path
75	Ramkrishna Mission Sarada Sevashrama	P.O.: Joyrambati, Bankura	Path
76	Ramkrishna Mission Charitable dispensory	P.O.: Joyrambati, Bankura	Clinic
77	Ramkrishna Pathological Lab	Vill. & P.O.: Onda, Bankura	Path
78	Ramkrishna Seva Sadan	Pratap Bagan, Bankura	Path
79	Rasulpur Pathological Laboratory	Rasulpur Bazar, P.O.: Rasulpur, Bankura	Path
80	Ritawari Diagnostic Centre	Pathpur, PO. & Dist. Bankura	Path
81	Roy Laboratory	Rabindra Sarani, Bankura	Path
82	Sahana Ultrasound	Kabardanga, PO. & Dist. Bankura	Path

LIST OF DIAGNOSTIC CENTRES BY DISTRICT

Sl. No	Name of the Units.	Address	Services Catered
83	Samadhan Paht Lab	Kotulpur, Bankura	Path
84	Sandhya Pathology	Sonamukhi Rathtala PO. Sonamukhi, Dist. Bankura	Path
85	Sanjibani Diagnostic Lab.	College Road, Bishnupur, Bankura	Path
86	Sanjiban X-ray & Sono Clinic	Kenduadihi, Bankura	X-Ray
87	Sanjiban X-Ray Clinic	Kenduadihi, Bankura	Path
88	Sarada Pathological Center	Kumbhasthal, Salda, Joypur, Bankura	Path
89	Sarada X-Ray Clinic	Belpara, PO. Bishnupur, Dist. Bankura.	X-Ray
90	Shristi Diagnostic & Research Center (P) Ltd.	School Danga, Bankura	Path
91	Spandan C.T. Scan Center	Gobindanagar, Kenduadihi, Dist. Bankura	CT. SCAN
92	Sonamukhi R. H. USG & Pathology Centre	Sonamukhi, Dist. Bankura	U.S.G & Path
93	Sristi Diagnostic Center (P) Ltd.	262, Schooldanga, Bankura	Path
94	Suman X-Ray Clinic	PO. Kamalpore, Dist. Bankura	X-Ray
95	Suraksha Diagnostic Center	Vill & PO. Barjora, Bankura	Path
96	Suraksha Pathological Laboratory	Pahtakpara, Bankura	Path
97	Swastik X-Ray Clinic	Barakalitala, Bankura	X-Ray
98	Sweta Medi - 1 Diagnostic Ltd.	Kenduadihi, Bankura	Path
99	The Mordern Diagnostic Center	Lal Bazar, Bankura	Path
100	Turning Point Diagnostic Center	Pathput Road, Front of Stadium, Dist. Bankura	Path
101	Vivekananda Pahtological Laboratory	Bhairabsthan, Kenduadihi, Bankura	Path
102	X-Ray Clinic	Natunchati, Bankura	X-Ray
Numbers of Path Lab: 72 ; Blood Bank: 0 ; Dental Clinic: 0 ; Forensic Lab: 0 ;			
BIRBHUM			
1	Amit Diagnostic Center	Rampurhat, Birbhum	Path
2	Anneswan	Lalkuthipara, Suri	Path
3	Appolo Diagnostic Laboratory	New Hospital Road, Rampurhat, Birbhum	Path
4	Ashadeep Diagnostic Center	Bharsalapara, New Hospital Road, P.O.: Rampurhat, Birbhum	Path
5	Bacto Clinical Laboratory	Rampurhat, Birbhum	Path
6	Bamdeb Diagnostic Center	Rampurhat, Birbhum	Path
7	Banerjee Diagnostic & Res. Foundation	Sainthia, Birbhum	Path
8	Bengal Clinical Laboratory	Vill. & P.O.: Nalhat, Birbhum	Path
9	Bengal Laboratory	Sekhempur, P.O.: Gadharpur	Path
10	Bengal X-Ray Clinic	Bolpur, Birbhum	X-Ray
11	Bio-Chem Clinical Laboratory	Bhubandanga, Bolpur	Path
12	BioChem Laboratory	New Dangalpara, P.O.: Suri, Birbhum	Path
13	Bio-Chem Laboratory	Dangalpara, Suri	Path
14	Bipin Pathological Center	Ahammadpur, Birbhum	Path
15	Birbhum Clinical Laboratory	Nalhati, Township, Birbhum	Path
16	Birbhum Computerised Laboratory	Sonatopara, Suri	Path
17	Birbhum Laboratory	Lalkuthipara, Suri	Path
18	Bolpur Diagnostic Center	Santiniketan Road, Super Market, Bolpur, Birbhum	Path
19	Bolpur Laboratory	Jambuni, Bolpur, Birbhum	Path
20	Central Laboratory	Suri, Birbhum	Path
21	City Laboratory	Dangalpara, Suri	Path

LIST OF DIAGNOSTIC CENTRES BY DISTRICT

Sl. No	Name of the Units.	Address	Services Catered
22	Clinical Laboratory	Dhuladanga, Rampurhat, Birbhum	Path
23	Dey's Laboratory	Dubrajpur, Birbhum	Path
24	Diagnostic Center	Rampurhat, Birbhum	Path
25	Diagnostic Research Division	Sainthia, Birbhum	Path
26	Doctor's Diagnostic	Rampurhat, Birbhum	Path
27	Dr. Mondals Laboratory	Md. Bazar, Birbhum	Path
28	Dreamland Diagnostic Center	Sonatanpur, Suri, Birbhum	Path
29	Dreamland Diagnostic Center	Dangalpara, Suri, Birbhum	Path
30	Dubrajpur Computerised Diagnostic Center	Dubrajpur, Birbhum	Path
31	Durgapur Diagnostic Center	Illambazar, Birbhum	Path
32	Dutta Pathological Laboratory	Suri, Birbhum	Path
33	Dutta Polyclinic & Laboratory	Ahamedpur, Bolpur Road, Birbhum	Path
34	Dynamik Clinic	Rampurhat, Birbhum	Path
35	Dynamik Clinic of Science	P.O.: Rampurhat, Birbhum	Path
36	Early Detection Diagnostic	Mururai, Birbhum	Path
37	Geniorth Laboratory	Rampurhat, Birbhum	Path
38	Giri Lab	Seharapara, P.O.: Suri, Birbhum	Path
39	Indralok Polyclinic	Sonatorepara, Suri, Birbhum	Path
40	Jamini Computer Laboratory	Benimadhab More, Suri, Birbhum	Path
41	Janakalyan Laboratory	N.M.K. Road, Rampurhat, birbhum	Path
42	Jeevandeep laboratory	Rampurhat, Birbhum	Path
43	Kiran Pathological Center	Dubrajpur Road, ILLambazar, Birbhum	Path
44	Life Care Pathological Laboratory	S.P. More, Suri, Birbhum	Path
45	Loknath Laboratory	Ahamedpur, Birbhum	Path
46	Ma-Fullora Pathological Laboratory	Labpur, Birbhum	Path
47	Mahananda Diagnostic Center	Hospital Gate, Sainthia, Birbhum	Path
48	Mallapur Pathological Clinic	Mallapur, Birbhum	Path
49	Mandal Laboratory	Mallapur, Birbhum	Path
50	Mata Smriti Seva Kendra	Narayanpur, Birbhum	Path
51	Medeo-Diagnostic Center	Rampurhat, Birbhum	Path
52	Medi Lab	Mission Compound, Bolpur, Birbhum	Path
53	Medilab	Islampur, Dubrajpur, Birbhum	Path
54	Medilab	Dubrajpur, Birbhum	Path
55	Medilab Diagnostic	Labpur, Birbhum	Path
56	Micro Clinical Lab.	Islampur, Dubrajpur, Birbhum	Path
57	Micro Diagnostic Laboratory	Rampurhat, Birbhum	Path
58	Mollapur X-Ray Pathological Laboratory	P.O.: Mollapur, Birbhum	Path, X-Ray
59	Mondal Laboratory	Ganeshpur, P.O.: Kabilpur, Birbhum	Path
60	Mordern Computer Treatment Center & Pathology	Bharsalapara, Rampurhat, Birbhum	Path
61	Mordern Laboratory	Rampurhat, Birbhum	Path
62	Mordern Patho Lab	Md. Bazar, Birbhum	Path
63	Mordern Pathological laboratory	Bolpur, Birbhum	Path
64	Mordern Scientific Laboratory	Illambaar, Birbhum	Path
65	Naba Diagnostic Laboratory	New Hospital Road, Rampurhat, Birbhum	Path

LIST OF DIAGNOSTIC CENTRES BY DISTRICT

Sl. No	Name of the Units.	Address	Services Catered
66	Neuclear Diagnostic Center	Rampurhat, Birbhum	Path
67	New Life Line Diagnostic Center	Rampurhat, Birbhum	Path
68	Niramoy Laboratory	Bharsalapara, Rampurhat, Birbhum	Path
69	Nirikshan	Bolpur, Birbhum	Path
70	Nirikshan Pathological Laboratory	Dubrajpur, Islampur (near Boltala), Birbhum - 731 123.	Path
71	Nirikshwan	Islampur, Dubrajpur	Path
72	Nirikshwan	Nalhati, Cinematala Lane, Birbhum	Path
73	Nivedita Care Home	Bus Stand, Suri, Birbhum	Path
74	Pastur Patho Lab	Near Rail Station, Labpur, Birbhum	Path
75	Patho Clinic	Rabindra Plaay, Suri	Path
76	Patho Imagine Center	R. K. Singha Road, Bolpur, Birbhum	Path
77	Pathological Laboratory	Panrui, Birbhum	Path
78	Pathological Laboratory	Mallarpur, Birbhum	Path
79	Pioneer Clinic	Nalhati, Birbhum	Path
80	Rampurhat Clinic	New Hospital Road, Rampurhat, Birbhum	Path
81	Rampurhat Diagnostic Center	Bharsalapara, Rampurhat, Birbhum	Path
82	Renuka Diagnostic Laboratory	Murarai, Birbhum	Path
83	River View Laboratory	Sainthia, Birbhum	Path
84	Rog Nirupan Pathological Laboratory	Near S. D. Hospital, Bolpur, Birbhum	Path
85	S. N. Diagnostic Center	Rampurhat, Birbhum	Path
86	S. Pathology Center	Rampurhat, Birbhum	Path
87	Sagarika Diagnostic Center	New Hospital Road, Rampurhat, Birbhum	Path
88	Saha Diagnostic Center	Nanoor, Birbhum	Path
89	Saithia Central Laboratory	Sainthia, Birbhum	Path
90	Sanjibani	770/357, Anandapur Road, Dangalpara, Suri, Birbhum	Path
91	Santiniketan Eye Care & Microsurgery Research	Bolpur, Birbhum	Path
92	Sarada Pathological Investigation Center	Nutanpalli, Bolpur, Birbhum	Path
93	Scientific Laboratory	Lalkuthipara, Suri, Birbhum	Path
94	Scientific Laboratory	Labpur, Birbhum	Path
95	Seva Medicare (Patho Lab)	Old Dangal Para, Suri, Birbhum	Path
96	Sharma X-Ray Clinic	Dubrajpur, Hetampur Road. Birbhum	X-Ray
97	Shome Diagnostic Center	M.N.K. Road, Bharsala More, P.O. & P.S.: Rampurhat,	Path
98	Span Pathological Lab	Rampurhat, Birbhum	Path
99	St. John Ambulance Association Laboratory	Labpur, Birbhum	Path
100	Suraksha	Lalkuthipara, Suri	Path
101	Suraksha	Rampurhat, Birbhum	Path
102	Suri Diagnostic Lab	Lalkuthipara, Suri	Path
103	Suruchi Diagnostic Center	New Hospital Road, Rampurhat, Birbhum	Path
104	Tripti Clinical Laboratory	Dubrajpur, Birbhum	Path
105	Tropical Pathological Clinic	Sainthia Nazrul Sarani, Sainthia, Birbhum	Path
Numbers of Path Lab: 103 ; Blood Bank: 0 ; Dental Clinic: 0 ; Forensic Lab: 0 ;			

LIST OF DIAGNOSTIC CENTRES BY DISTRICT

Sl. No	Name of the Units.	Address	Services Catered
BURDWAN			
1	Abantica Clinical Laboratory	Bhatar Bazar, (Kumar Para More), P.O.: Bhatar, Burdwan	Dental
2	Abhijit Lab	Bus Stand, Kalna, Burdwan	Outdoor
3	Al Ameen Diagnostic Center	S.T.K.K. Road, Baramitrapara, Kalna, Burdwan	Path
4	Ali & Santra Pathological Center	New Market, Memari, Burdwan	Path
5	Analysar Pathological Laboratory	1no. Hospital Gate, Khoshbagan, Burdwan	Path
6	Analysis Clinical Pathological Laboratory	Kachari Road, Katwa, Burdwan	Path
7	Anubikshan Diagnostic Center	Near S. D. Hospital, S. B. Gorai Road, Asansol - I, Burdwan	Path
8	Apollo Diagnostic Unit	36, Khoshbagan, Burdwan	Path
9	Apollo Laboratory	RG/8, Apollo Avenue, Bidhan Nagar	Path
10	Appex Diagnostic Center	Ramkrishna Road, Burdwan	Path
11	Astha Diagnostic Center	36, R.B. Ghosh Road, Burdwan	Path
12	Aviskar Diagnostic Center (P) Ltd.	"Nivedita Apartment" West Apar Garden, Asansol,	Path
13	B.M.C. U.S.G. Clinic	Mallick Bazar, Khoshbagan, Burdwan	Path
14	Bakshi Diagnostics	1/1, D. N. Mitra Lane, Khosbagan Burdwan	Path
15	Banerjee X-Ray Clinic	Kachari Road, Katwa, Burdwan	Path
16	Benachity X-Ray Clinic	Nachan Road, Benachity, Durgapur, Burdwan	Path
17	Bengal Pathological Laboratory	18, R. K. Ghosh Road, Burdwan	Path
18	Bengal X-Ray Clinic	Bhimghi Kalibari, Nachan Road, Benachity, Durgapur	Path
19	Bikshan Diagnostic Center	S.T.K.K. Road, Madhuban, Kalna, Burdwan	Path
20	Biochem Pathological Laboratory	49, R. K. Ghosh Road, Burdwan	Path
21	Biswaa Clinic	Sundar Chak, Asansol, Burdwan	Path
22	Bose Clinical Laboraotries (P) Ltd.	29, Kalinagar Para, P.O. & P.S. : Kalna, Burdwan	Path
23	Burdwan Cliical Laboratory	No.1, Raj Dispensary Road, Burdwan	Path
24	Care Pathology	Nachan Road, Durgapur, Burdwan	Path
25	Clinical Laboratory	P.O. & P.S.: Raniganj, Burdwan	Path
26	Carewell Pathology Laboratory	Tara Enclave, S. B. Gorai Road, Hill View Park (N), Asansol	Path
27	Dhannantary	H.C.L. Road, Rupnarayanpur Bazar, Rupnarayanpur, Burdwan	Path
28	Diagnostic Laboratory	HCL Road, P.O.: Rupnarayanpur, Burdwan	Path
29	Diagnostic Pathological Laboratory	Doctor's Colony, Rambagan, P.O.: Serasole, Raniganj,	Path
30	Disha Pathology Center	Bijay Path Apartment, Samiron Roy Road, Asansol, Burdwan	Path
31	Diya X-Ray Clinic	Kachari Road, Katwa, Burdwan	Path
32	Doctor's Diagnostic Center	Khoshbagan, Burdwan	Path
33	Dolphin Diagnostic Center	S.B. Gorai Road, 147/44, Sreepally More, P.O.: Asansol,	Path
34	Dolphin Diagnostic Center	(Opp Doly Lodge), Burnpur Road, Asansol,	Path
35	Dr. B. C. Roy Diagnostic	Doctor's Colony, Durgapur-16, Burdwan	Path
36	Dr. B. C. Roy Medical Institutes	Durgapur-16, Burdwan	Path
37	Dr. B.C. Saha X-Ray Clinic	62, R. B. Ghosh Road, Burdwan	Path
38	Dr. Niyogi's Surgical Clinic	E 59, Astronauts Avenue, Durgapur-12, Burdwan	Path
39	Dr. Panchanan Roy Vocational Tranning Institute	Monteswar, Burdwan	Path
40	Durgapur Pathology	3/1, Central Park, City Center, Durgapur, Burdwan	Path
41	Durgapur Ultrasound Clinic	Sasanka Pally, J.P. Avenue, Sagar Bhanga, Durgapur,	Path
42	Durgapur X-Ray Clinic	J.P. Avenue, Sagar Bhanga, Durgapur-11, Burdwan	Path
43	Dutta Clinical Laboratory	Rupnarayanpur, Burdwan	Path

LIST OF DIAGNOSTIC CENTRES BY DISTRICT

Sl. No	Name of the Units.	Address	Services Catered
44	Endolap Surgical Institute & Medical Center (P) Ltd.	City Center, Durgapur, Burdwan	Path
45	ESDEE Diagnostic & Res. Center	Bhiringhi, Durgapur-13, Burdwan	Path
46	G. K. Pathology	Khudiram Sarani, City Center, Durgapur, Burdwan	Path
47	Guskara Diagnostics Center	Gushkara (Bus Stand), Burdwan	Path
48	Guskara X-Ray Clinical & Scan Center	2nd Duckbungalow shopping Complex, Guskara, Burdwan	Path
49	Health & Patho Clinic	Court more, Asansol-4, Burdwan	Path
50	Health Care Pathological Laboratory	P.O.: Nasaratpur, Purbasthali, Burdwan	Path
51	Health Care X-Ray	P.O.: Nasaratpur, Purbasthali, Burdwan	Path
52	Image Scan Center	Searsol , Rambagar, Raniganj, Burdwan	Path
53	Immuno Points	8, R. B. Ghosh Road, Khoshbagan, Burdwan	Path
54	Indira Gandhi Memorial Hospmnt Only)	SAIL-ISP, P.O. & P.S.: Kulti, Burdwan	Path
55	Indian Red Cross Society,	Durgapur Sub Divisional Branch, City Center, Durgapur,	Path
56	Jiban Pradip Diagnostic Center	Madhupur, P.O.: Simlon, Burdwan	Path
57	Jyanaranjan Rashmi (I)	Near Devey Pharmacy, P.O. & P.S.: Asansol, Burdwan	Path
58	Jyanaranjan Rashmi (II)	Burnpur Road, P.O.: Asansol, Burdwan	Path
59	Kalitala Diagnostic Clinic	Fouzdari Kalitala, Khoshbagan, Burdwan	Path
60	Kalna X-Ray Clinic	Kalinagarpara, Kalna, Burdwan	Path
61	Kalpataru Diagnostic Center	Show Sarker More, Kalna, Burdwan	Path
62	Katwa Heath Care	Katwa Kachari Road, Katwa, Burdwan	Path
63	Khoshbagan X-Ray Center	10, R.B.Ghosh Road, Burdwan	Path
64	Kiran Pathological Center	Gushkara (Bus Stand), Burdwan	Path
65	Lali Diagnostic Laboratory	1/2, Lower Chelidanga, P.O.: Asansol, Burdwan	Path
66	Loyal Pathology	R. B. Ghosh Road, Burdwan	Path
67	Life Aid Clinical Laboratory	Kalinagarpara, Kalna, Burdwan	Path
68	Life Care Diagnostic Center	63, R.B. Ghosh Road, Khosbagan, Burdwan	Path
69	Life Line	Chittaranjan, Burdwan	Path
70	Life Line Clinical Laboratory	Soumeshwartala Goli, P.O.: Memari, Burdwan	Path
71	Life Line Lab	RA-51, S.S.B. Sarani, Sector-2B, Durgapur-12, Burdwan	Path
72	Life Line Patho Daignostic Laboratory	Chatterjee Commercial Complex, Lithuria Road, Neamatpur,	Path
73	Loyal Pathological Laboratory	B.B. Ghosh Road, P.S.: Burdwan	Path
74	Maa Durga Diagnostic Center	26, N.S. Road, Asansol, Burdwan	Path
75	Maa Fouzdari X-Ray Clinic	Khoshbagan (Opp. Volly Ball Ground) ,Burdwan	Path
76	Maa Sarada X-Ray Clinic	65, R. B. Ghosh Road, Khosbagan, Burdwan	Path
77	May Fair Polyclinic	Sidheswari Market, Mamrabazar, Durgapur, Burdwan	Path
78	Medicare Diagnostic Center	Mamra Bazar, Durgapur, Burdwan	Path
79	Medicare Diagnostic Center	S.T.K.K. Road, Baramitrapara, Kalna, Burdwan	Path
80	Medicare Images,	Snehar Apartment, Courtmore, Burnpur Road, Asansol, Burdwan	Path
81	Medicare Pathological Center	Satgachia Memari Road, Burdwan	Path
82	Medico Clinical Laboratory	Subhasis Market, Samudragarh, P.S.: Nasratpur, Burdwan	Path
83	Medinova Diagnostic Center	1No. Pakmara Goli, Burdwan	Path
84	Mediscan	Block No.-I, City Center, Durgapur-16, Burdwan	Path
85	Mediscan U.S.G.	Block No.-II, Commercial Estate, Durgapur-16, Burdwan	Path
86	Mediscan U.S.G.	Block No.-III, Commercial Estate, Durgapur-16, Burdwan	Path
87	Meditest Pathological Laboratory	6, Khosh Bagan Lane, Burdwan	Path
88	Memari Diagnostic Clinic	New Bus Stand, Memari, Burdwan	Path

LIST OF DIAGNOSTIC CENTRES BY DISTRICT

Sl. No	Name of the Units.	Address	Services Catered
89	Mersissus Medical Center	Kachari Road, Katwa, Burdwan	Path
90	MIMS India Diagnostic Center	76, R. B. Ghosh Road, Khosbagan, Burdwan	Path
91	Monorama Medi-Lab & Diagnostic Center	38, Moulana Azad Sarani, City Center, Durgapur, Burdwan	Path
92	Mordern Diagnostic Center	Station Road, P.O.: Burnpur, P.S.: Hirapur, Burdwan	Path
93	Mordern X-Ray Clinic	Station Road, P.O.: Burnpur, Burdwan	Path
94	Mother Care	4/6, Central Park, Doctor's Colony, City Center, Durgapur,	Path
95	N.C. Investigation	P.O.: Ukhra, Burdwan	Path
96	Narcissu Medical Center (P) Ltd.	Kachari Road, Katwa, Burdwan	Path
97	National Diagnostic	Nachan Road, Benachity, Durgapur, Burdwan	Path
98	National Pathological Laboratory	G.T. Road, P.O. & P.S.: Memari, Burdwan	Path
99	National X-Ray Clinic	G.T. Road, P.O. & P.S.: Memari, Burdwan	Path
100	Neo Diagnostic Researc Center	N.R.R. Road, Asansol, Burdwan	Path
101	New Burnpur Laboratory	Subhas Pally Main Road, P.O.: Burnpur, Burdwan	Path
102	New Diplomat	Khoshbagan ,Burdwan	Path
103	New Diplomat Diagnostic Center	Gandhi Market, Room No. 7, Kachari Road, Katwa, Burdwan	Path
104	New Kalna Clinical Lab	Kalna, Burdwan	Path
105	New Medinova Diagnostics	67, Station Road, P.O.: Burnpur, Burdwan	Path
106	New Pathological Center	72, R.B. Ghosh (Bose Market), Khoshbagan, Burdwan	Path
107	New Scientific Lab	Lenin Sarani, Katwa, Burdwan	Path
108	Nilima Diagnostic Center	16/1, R. B. Ghosh Road, Khoshbagan, Burdwan-101	Path
109	Niramoy Pathological Laboratory	25, R. B. Ghosh Road, Khoshbagan, Burdwan	Path
110	Nirnoy Pathological Laboratory	67, R.B. Ghosh Road, Khoshbagan, Burdwan	Path
111	Nursecare Diagnostic Center	Guha Market, Jamalpur, Burdwan	Path
112	Oskar Diagnostic Center	Asansol Marble House Complex, West Apear Garden, P.O.:	Path
113	Pahtological	Chittaranjan, Burdwan	Path
114	Pahtological Laboratory	Searsol Rajbari, Burdwan	Path
115	Pan Laboratory	Koshbagan, Burdwan	Path
116	Pan Path	Bhatchala, Burdwan	Path
117	Pathlogy	Aesbay More, Station Road, Durgapur, Burdwan	Path
118	Pathogical Center	Rabundra Sarani, Gushkar, Burdwan	Path
119	Pathological Investigation Clinic	Bara Nilpur Road, Burdwan	Path
120	Pathological Laboratory	1No. Pakmara Goli, Burdwan	Path
121	Pathological Laboratory	Memari, Burdwan	Path
122	Pathological Laboratory	R. B. Ghosh Road, Burdwan	Path
123	Pathology Center	P.O.: Lakurdih, Burdwan	Path
124	Pauls Diagnostic Laboratory	394, Subhaspally Main Road, P.S.: Hirapur, P.O.: Burnpur,	Path
125	Physiotherapy Center	Ranisayer, Burdwan	Path
126	Ramkrishna X-Ray Clinic	67 M, R.B. Ghosh Road, Burdwan	Path
127	Rasmoni Diagnostic Center	R. B. Ghosh Road, Burdwan	Path
128	Real Scan (Ultrasonography Unit)	Apollo Avenue, Bidhannagar, Durgapur, Burdwan	Path
129	S. D. Orodental Hospital (P) Ltd.	347, Burnpur Road, Near Court More, P.O. & P.S.: Asansol,	Path
130	Sandhan Diagnostic Center	39, R. B. Ghosh Road, Koshbagan, Burdwan	Path
131	Sanjivan	Khoshbagan, Burdwan	Path
132	Saraswati X-Ray Clinic	Dak Bungalow Road, Katwa Municipality, Burdwan	Path

LIST OF DIAGNOSTIC CENTRES BY DISTRICT

Sl. No	Name of the Units.	Address	Services Catered
133	SBIOA (Bengal Circle) Physiatry, Physiotherapy & Pathology	Srijani Complex, Krishnasayer, Burdwan	Path
134	Scan Point	62, R. B. Ghosh Road, Burdwan	Path
135	Scientific Clinical Laboratory	57, R.B. Ghosh Road, Khoshbagan, Burdwan	Path
136	Seba	Roy Market, Shalbagan Road, Benachity, Burdwan	Path
137	Seba Sadan Clinic		Path
138	Seba Scan	Kashuka Market, Shib Mandir Road, Barakar, Burdwan	Path
139	Sen Clinical Laboratory	101, S.B. Gorai Road, P.S.: Asansol (S), Burdwan	Path
140	Seva Diagnostic & Research Center	Subhaspally Main Road, Burnpur, Burdwan	Path
141	Sevasadan Pathological Clinic	Sidheswari More, P.O. & P.S.: Kalna, Burdwan	Path, X-Ray
142	Sevasadan Ultra Sound Clinic	Sidheswari More, P.O. & P.S.: Kalna, Burdwan	Path, X-Ray
143	Sevasadan X-Ray	Sidheswari More, P.O. & P.S.: Kalna, Burdwan	Physiotherapy
144	Shanti Clinic	Vill. & P.O.: Laudoha, Burdwan	Physiotherapy
145	Shivam Scan Diagnostic	D/178, Shastri Avenue, Durgapur, Burdwan	U.S.G.
146	Shyam Sundar X-Ray Clinic	Shyam Sunder, P.O.: Sure Kalna, Burdwan	U.S.G.
147	Single Point Diagnostic Clinic	16/1, R. B. Ghosh Road, Khoshbagan, Burdwan-101	U.S.G.
148	Sonography Clinic & Leparoscopy Center	17, P.N. Malia Road, Raniganj, Burdwan	U.S.G.
149	Spandan Diagnostic Center (P)	Kenna, Burdwan	X-Ray
150	Sri Sri Bijoy Krishna Chakhu Chikitsha Kendra	Upper Japat, P.O.: Kalna, Burdwan	X-Ray
151	Srikrishna Diagnostic Center	Sure Kalna (Phatock Gora), P.O.: Sure Kalna, Burdwan	X-Ray
152	Standard Patho. Lab,	Panagarh Bazar, Old Kanksa Road, Mukherjee Market,	X-Ray
153	State Bank of India Officer's Association (Bengal Circle)	Krishnasayer Eco-Garden Mahatas Road, Burdwan	X-Ray
154	Subarna Diagnostic Center	Satgachia Bazar, P.O.: Satgachia, Memari, Burdwan	X-Ray
155	Subarna Polyclinic Center	Satgachia Bazar, P.O.: Satgachia, Memari, Burdwan	X-Ray
156	Subhas Clinic & USG Scan Center	Searsol Rajbari, Burdwan	X-Ray
157	Sudha Well Known Clinic	F, 46, Ispat Pally, Bidhannagar, Durgapur, Burdwan	X-Ray
158	Super X-Ray Clinic	36, Khoshbagan, Burdwan	X-Ray
159	Suraksha Diagnostic	25, Khoshbagan, Burdwan	X-Ray
160	Sure Kalna X-Ray Clinic	Vill & P.O.: Sure Kalna, Burdwan	X-Ray
161	The Katwa Scan Center	Duckbunglo Road, Katwa, Burdwan	X-Ray
162	The Katwa Scan Center	College Para, Dakbanglo Road, Katwa, Burdwan	X-Ray
163	The Patho Lab.	Roy Market, Muchip0ara, Durgapur-12, Burdwan	X-Ray
164	Tirupati Diagnostic Center	Ramkrishna Road, Ranisagar (North), Burdwan	X-Ray
165	Ukhra Diagnostic Center	NSB Road, Ukhra, Burdwan	X-Ray
166	United X-Ray & Scan Center	P.O.: Asansol, P.S.: Asansol (S), Burdwan	X-Ray
167	We Care	Sen Para, Madhuban, Kalna, Burdwan	Not specified
Numbers of Path Lab: 140 ; Blood Bank: 0 ; Dental Clinic: 1 ; Forensic Lab: 0 ;			
COOCHBEHAR			
1	Astha Diagnostic & Medical Research Center	262, Silver Jubilee Road, Cooch Behar	Path
2	B.B.S. Mediscan	40, Sunity Road, Cooch Behar	U.S.G
3	BBS Mediscanners Pvt. Ltd.	26A, Sunity Road By Lane, Coochbehar	Path
4	City X-Ray Clinic	Biswa Singha Road, P.O.: & Dist. Cooch Behar	X-Ray
5	Coochbehar Laboratory	R.R.N. Road, P.S.: Kotwali, Cooch Behar	Path
6	Coochbehar X-Ray Clinic	Rasaraj Building, BS Road, Coochbehar	X-Ray
7	Dey's X-Ray Clinic	Main Road (Opp. Fire Station) P.O.: Dainhat, Cooch Behar	X-Ray

LIST OF DIAGNOSTIC CENTRES BY DISTRICT

Sl. No	Name of the Units.	Address	Services Catered
8	Dhanya Laboratory	Mathabhanga, Cooch Behar	Path
9	Dhanya X-Ray Clinic	Coochbehar	X-Ray
10	Diagnostic X-Ray Scan	228, S, N. Road, Cooch Behar	X-Ray
11	Dinhata X-Ray & Diagnostic Center	Godhuli Bazar Main Road, Dinhata, Cooch Behar	X-Ray
12	Diya Diagnostic Center	Kachari More, P.O.: Coochbehar, P.S.: Kotwali, Coochbehar	Path
13	Guha Pathological Laboratory	Changrabandha, Cooch Behar	Path
14	India Laboratory	Biswas Para, Cooch Behar	Path
15	Joy Lakshmi Laboratory	Hospital Road, Mathabhanga, Cooch Behar	Path
16	Kasturi Ultra Sound Clinic	Sunity Road, P.S.: Kotawali, Coochbehar	U.S.G
17	Kosturi Ultrasound Clinic	Podder Seva Sadan Premises, Sunity Road, Cooch Behar	U.S.G
18	Laxmi Narayan X-Ray Clinic	Silver Jublee Road, P.O.: Coochbehar, Coochbehar	Path
19	Maa Pathological Laboratory	D. B. Para, Hospital Road, Mathabhanga, Cooch Behar	Path
20	Madan Mohan Laboratory	Main Road, Dainhat, Cooch Behar	Path
21	Madan Mohan X-Ray Clinic	Biswa Singha Road, P.O.: & Dist. Cooch Behar	X-Ray
22	Mathabhanga Pathological Laboratory	Deshbandhu Para, Mathabhanga, Cooch Behar	Path
23	Mathabhanga S.W.O, Lab & Diagnostic Center	Office Para, Mathabhanga, Cooch Behar	Path
24	Mathabhanga X-Ray Clinic	Hospital Road, Mathabhanga, Cooch Behar (Ward No. - 7)	X-Ray
25	Mathabhanga X-Ray Clinic	Deshbandhupara, Hospital Road, P.O.: Mathabhanga, (W-8)	X-Ray
26	Matri Clinical Laboratory	Rasaraj Building, BS Road, Coochbehar	Path
27	Mili Pathological Laboratory	D. B. Para, Hospital Road, Mathabhanga, Cooch Behar	Path
28	Mordern Diagnosic Center	Sunity Road bylane, Cooch Behar	Path
29	Nath Clinical Laboratory	5, Hitendra Narayan Road, Cooch Behar	Path
30	Nirnay Pathological Laboratory	Hospital Road, Mathabhanga, Cooch Behar	Path
31	Niyati Diagnostics	Sunity Road, Bylane, P.S.: Kotwali, Coochbehar	Path
32	North Bengal Diagnostic Center	B.S. Road (South), Coochbehar	Path
33	North Bengal X-Ray Clinic	Deshbandhupara, Hospital Road, P.O.: Mathabhanga, Cooch Behar	X-Ray
34	Panacca Diagnostic Center	Natun Bazar, B.S. Road, Cooch Behar	Path
35	Paul Clinic & Diagnostic Laboratory	Coochbehar	Path
36	Pauls Laboratory	7, N. N. Road, Coochbehar	Path
37	Paul's Laboratory	Naranarayan Road, Cooch Behar	Path
38	Podder Seva Sadan X-Ray Clinic	Sunity Road P.O.: & Dist Cooch Behar	X-Ray
39	R. K. Pathological Laboratory	H. Road, Coochbehar	Path
40	Ramkrishna Pathological Laboratory	Hospital Road, Mathabhanga, Cooch Behar (Ward No. - 7)	Path
41	S. B. Laboratory	Biswa Singha Road, P.O.: & Dist. Cooch Behar	Path
42	S. S. Laboratory	Sunity Road bylane, Cooch Behar	Path
43	S.B. Laboratory	Biswa Singha Road, P.O.: & Dist. Cooch Behar	Path
44	Sabitri Diagnostic Clinic	B.D.O. Office Road, P.O.: Tufangunj, Cooch Behar	Path, X-Ray
45	Sandhya Laboratory	Bazar Road, Haldibari, Cooch Behar	Path
46	Sathick Pathological Laboratory	D. B. Para, Hospital Road, Mathabhanga, Cooch Behar	Path
47	Sayan Pathological Laboratory	Hospital More, Ward No.: 5, P.O. & P.S.: Dinhata, Coochbehar	Path
48	Sebayan Laboratory	Main Road, Tufangunj, Cooch Behar	Path
49	Sebayan Laboratory	P.O.: Rampur, P.S.: Bakshirhat, Cooch Behar	Path
50	Soma Pathological Laboratory	Deshbandhu Para, Mathabhanga, Cooch Behar	Path
51	Spandan Diagnostic Clinic	234, B. S. Road, Tetultala, Cooch Behar	Path

LIST OF DIAGNOSTIC CENTRES BY DISTRICT

Sl. No	Name of the Units.	Address	Services Catered
52	Spot Pathological Laboratory	M.N.J. Road, Cooch Behar	Path
53	SS Laboratory	Sunity Road bylane, Cooch Behar	Path
54	Subham Hospital & Diagnostics Center (P) Ltd.	N.N. Road, P.S.: Kotowali, Cooch behar	Path
55	Subham Scan	59, Naranarayan Road, Cooch Behar	U.S.G
56	Suma Pathological lab	Hospital Road, Coochbehar	Path
57	Sunny Laboratory	Thanarmore, Dainhat, Cooch Behar	Path
58	Swasti Pathological Laboratory	Hospital Road, P.O. & P.S.: Mathabhanga, Coochbehar	Path
59	The Clinical Laboratory	Biswa Singha Road, P.O. : & Dist. Cooch Behar	Path
60	The Laboratory	R.R.N. Road, Cooch Behar	Path
61	The Sun Clinical & Diagnostic Laboratory	Sudhanshi Market, Gunjabari, Coochbehar	Path
62	Ultrasonography Clinic	Main Road, (Opp. Fire St.), Dinahata, Cooch Behar	U.S.G
63	Unique X-Ray Clinic	Tufanganj Mini Bus Stand, Cooch Behar	Path, X-Ray
64	Usha Diagnostic Center	M.J.N. Road, Cooch Behar	U.S.G
65	Usha Diagnostic Center	M.J.N. Road, Cooch Behar	Path, X-Ray
66	Coochbehar Laboratory	R.N. Road, P.O.: Cooch Behar, P.S.: Kotwali,	Path
67	X-Ray Clinic of Subham Hospital	Naranarayan Road, Cooch Behar	Path, X-Ray
Numbers of Path Lab: 50 ; Blood Bank: 0 ; Dental Clinic: 0 ; Forensic Lab: 0 ;			
DAKSHIN DINAJPUR			
1	Buniadpur X-Ray Clinic	Buniadpur, Dakshin Dinajpur	X-Ray
2	Delta Pathological Laboratory	Harirampur, Dakshin Dinajpur	Path
3	Dhar Clinic & Lab.	Moktarpara Road, Balurghat, Dakshin Dinajpur	Path
4	Gangarampur Medical Center	Gangarampur (kaldihi), Dakshin Dinajpur	Path
5	Gangarampur Pathological Center	Gangarampur (kaldihi), Dakshin Dinajpur	Path
6	Gangarampur X-Ray Clinic	Durgabaripara, Gangarampur, Dakshin Dinajpur	X-Ray
7	Kushmondi Pathological Center	P.O.: Kushmondi, Dakshin Dinajpur	Path
8	Kusumati Patho Center	Dakshin Dinajpur	Path
9	Pratima Polyclinic	P.O.: Raiganj, Dakshin Dinajpur	Path
10	Raghunathpur Diagnostic Center	Raghunathpur, P.O.: B.T. Park, Dakshin Dinajpur	Path
11	Raghunathpur X-Ray Clinic	P.O.: B. T. Park, Dakshin Dinajpur	X-Ray
12	Sebika Pathological Laboratory	Trimohini, Dakshin Dinajpur	Path
13	Sonoscan Diagnostic Center	Matri Sadan Building, Sova majumder Sarani, Balurghat,	Path
14	Sraddaha Pathological Center	Kajebhag, P.O. & P.S.: Tapan, Dakshin Dinajpur	Path
15	The Quest X-Ray Clinic (Tapan Hospital)	P.O.: Tapan, Dakshin Dinajpur	X-Ray
16	Usha Pathological Lab.	P.O.: Gangarampur, Dakshin Dinajpur	Path
Numbers of Path Lab: 12 ; Blood Bank: 0 ; Dental Clinic: 0 ; Forensic Lab: 0 ;			
DARJEELING			
1	Anandalok Medical & Research Center (P) Ltd.	3/3, Hill Cart Road, Siliguri, Darjeeling	path
2	Anweshan	309/1, S. F. Road, Siliguri	Path
3	B. B. S. Mediscanners (P) Ltd.	Children Park, Siliguri, Darjeeling	X-Ray
4	B. S. Diagnostic Center	Bidhan Road, Siliguri, Darjeeling	Path
5	Barnali X-Ray	Bidhan Road, Siliguri, Darjeeling	X-Ray
6	Beekshan Clinical Pathological Laboratory	Seal Bhawan, Sibmandir, P.O.: Kadamtala, Siliguri, Darjeeling	Path
7	Bio Clinical Laboratory	Kalibari Road, Siliguri, Darjeeling	Path
8	Bio Pathological Laboratory	H. No. 450/695, Ward No. 21, P.O.: Rabindra Nagar, Siliguri,	Path

LIST OF DIAGNOSTIC CENTRES BY DISTRICT

Sl. No	Name of the Units.	Address	Services Catered
9	Bossh Diagnostic Center	C/o Basu Clinic, Nandalal Basu Sarani, College Para, Siliguri,	Path
10	Chowdhury X-Ray & Pathological Clinic	Ballen Villa Road, Darjeeling	Path, X-Ray
11	Daignostic Clinical Laboratory	Military Road, Shiv Mandir, P.O.: Kadamtala, Darjeeling	Path
12	Darjeeling & Dooars Medical Association	Neheru Raod, Darjeeling	U.S.G
13	Dey's Laboratory	B.S. Sarani, Hakimpara, Siliguri, Darjeeling	Path
14	Diagnostic & X-Ray Center	57, Hill Cart Road, Kurseong, Darjeeling	Path, X-Ray
15	Diagnostic Center	Babupara Main Road, Siliguri, Darjeeling	Path
16	Diagnostic Clinic Laboratory	Military Road, Shiv Mandir, P.O.: Kadamtala, Darjeeling	Path
17	Down Town Diagnostic	Main Road, Lower Bagdogra, Darjeeling	Path
18	Dr. Ghosh Laboratory	Rishi Arobinda Road, Siliguri, Darjeeling	Path
19	Dr. Kalpana Roy (Ghosh) Laboratory	Haren Mukherjee Road, Siliguri, Darjeeling	Path
20	Dr. Mallick's Pathlogy Lab	K. C. Dey Road (Hill Cart Road), Siliguri, Darjeeling	Path
21	Dr. Rudra. N. Agarwal Diagnostic & Research Center	Kurseong, Darjeeling	Path
22	Echo Mediscanners	371, Hill Cart Road, Bara Kakjhora, P.O. & P.S.: Darjeeling,	Path
23	Eko Imaging Institute	C/o North Bengal Clinic (P) Ltd., Pradhan Nagar, Siliguri, Darjeeling	Path
24	Eric Paul Clinical Laboratory	41, B. D. Raod, Kurseong, Darjeeling	Path
25	Good Luck Clinical Pathology Laboratory	39, Burdwan Road, Kalimpong	Path
26	Hanuman Pathlogical Laboratory	Ward No.- 18, Nibedita Market, Kachari Road, Siliguri,	Path
27	Hill Vue Medicare (P) Ltd.	Haren Mukherjee Road, Siliguri, Darjeeling	Path
28	Holly Palace Christan Center Health Clinic	Naxalbari, Darjeeling	Path
29	Human Pathological Laboratory	Siliguri, Darjeeling	Path
30	Jamgon Kongtrul Eye Center	8th Mile, Lower Bridle Road, P.O. & P.S.: Kalimpong,	Path
31	Life Line Diagnostic Center	Kimbadanti Building, Lower Bagdogra, Darjeeling	Path
32	Life Line Diagnostic Center	Judge Bazar, Darjeeling	Path
33	Ma Kamakhsya Clinical Investigation Center	2nd Mile, Sevok Road, Siliguri, Darjeeling	Path
34	Matri Clinical Laboratory	Railway Market, Alipurduar Jn. Jalpaiguri	Path
35	Matri Sangha Janakalyan Ashram	Siliguri Branch, 1 Balai Das Chatterjee Road, Hakimpara, Siliguri	Path
36	Mitras Clinic & Nursing Home	Hakimpara, Siliguri, Darjeeling	U.S.G
37	N. B. Diagnostic Center	Pradhan Nagar, Siliguri, Darjeeling	Path
38	Omkar Ultrasonography Center	Anjuman-E-Eslamia Buliding, Darjeeling	U.S.G
39	Pariksha Diagnostic Laboratory	Yadav Samiti Building, Hill Cart Road, Siliguri, Darjeeling	Path
40	Pathology Laboratory	Burdwan Road, Kurseong, P.S.: Kurseong, Darjeeling	Path
41	Rama Diagnostic Center	Sreema Sarani, Babu Para, Siliguri, Darjeeling	Path
42	S & B Polyclinic	Sukanta Pally, Pratikhya, P.O.: Bagdogra, Darjeeling	Path
43	S. S. Diagnostic Laboratory	Shib Mandir, Kadamtala, Darjeeling	Path
44	Sanjeevani Health & Hygine (P) Ltd.	Bidhan Road, Siliguri, Darjeeling	Path
45	Sankalpa Diagnostic Ltd.	Apollo Towers, 2nd floor, Sevok Road, Siliguri, Darjeeling	Path
46	Scientific Clinical Diagnostic Center	56, Hammond Road, P.O.: Kurseong, Darjeeling	Path
47	Sebayan Pathological Lab	Hakimpara, Siliguri, Darjeeling	Path
48	Sekhar Paul Diagnostic Center	Babupara, Siliguri, Darjeeling	Path
49	Sharmins Lab, Kalimpong	Rishi Raod (D. B. Giri Road), 10th Mile Kalimponj	Path
50	Siliguri Diagnostic Center	Nivedita Market, Kachari Road, Siliguri, Darjeeling	Path
51	Siliguri Scan Center	3, Rash Behari Sarani, Children Park, Siliguri	CT SCAN
52	Siliguri Welfare Organisation	4, Rabindra Angan, Kutchary Road, Siliguri, Darjeeling	Path

LIST OF DIAGNOSTIC CENTRES BY DISTRICT

Sl. No	Name of the Units.	Address	Services Catered
53	SonoDiagnostics, Frank Ross	14, J.N. Road, Darjeeling	Path
54	Star Diagnostic	10th Mile, S.D.B.G. Road, P.O.: Kalimpong, Darjeeling	Path
55	Suraksha Diagnostic & Eye Care Center (P) Ltd.	Ashrampara, Siliguri, Darjeeling	Path
56	T S L Pathological Center	Hakimpara, 23, Haren mukherjee Road, Siliguri, Darjeeling	Path
57	Tara Diagnostic Laboratory	3, Rash Behari Sarani, Children Park, Siliguri	Path
58	Tarun Roy's Pathological Laboratory	Sisir Bhaduri Sarani, Siliguri, Darjeeling	Path
59	The Microbes	Ramkrishna Road, IST By Lane Ashrampara, Siliguri,	Path
60	Town Laboratory, Siliguri	S. D. Hospital Road, Siliguri, Darjeeling	Path
61	Ugen Mindrol Saantenling Clinic	Gompa Dara, P.O.: Gitadabbling, Kalimpong, Darjeeling	Path
62	Ultrasonix	C/o. North Bengal Clinic, Pradhan Nagar, Siliguri, Darjeeling	U.S.G
63	Upkar Clinical Laboratory	Mirik, Darjeeling	Path
64	Yelung Diagnostic & Polyclinic	Damber, Chowk, Kalimpong	Path
65	Yuma Diagnostic Center	7A, Pallen Villa Road, Darjeeling	U.S.G
Numbers of Path Lab: 57 ; Blood Bank: 0 ; Dental Clinic: 0 ; Forensic Lab: 0 ;			
E. MIDNAPUR			
1	Amardyuti X-Ray Clinic	Durgachak, Haldia, Purba Medinipore	X-Ray
2	Analysis	Dharinda Rail Gate, P.O. & P.S.: Tamluk, Midnapore (E)	Path
3	Angur Diagnostic Center	Madhakhali, P.O.: Bhupatinagar, East Midnapore	Path
4	Anwesan	School Bazar, P.O. & P.S.: Contai, Midnapore (E)	Path
5	Anwasha Pathology Lab.	Vill.: Padumbasan, P.O. & P.S.: Tamluk, Purba Medinipore	Path
6	Anwasha Pathology Lab.	Athilagori, P.O. & P.S.: Contai, Midnapore	Path
7	Aparajita Pathological Laboratory	Paniparui Bus Stand, P.O.: Kasba, P.S.: Egra, Midnapore (E)	Path
8	Arogya Niketan	Padmabhusan, P.O. & P.S.: Tamluk, East Midnapore	Path
9	Arogya Niketan Medical Institute	Daharpur, P.O. & P.S.: Tamluk, Midnapore (E)	Path
10	Ashirbad X-Ray Clinic	P.O.: Nandigram, East Medinipore	Path
11	Assembly Diagnostic & Research	Vill.: Sankarara, P.O. & P.S.: Tamluk, Purba Medinipore	Path
12	Astideepa Path. Lab.	Daharpur, P.O. & P.S.: Tamluk, Midnapore (E)	Path
13	Banerjee Patho Lab.	Kakdihi, P.O.: Mechada, P.S.: Kolaghat, Purba Medinipore	Path
14	Bargabhima X-Ray & U.S.G. Clinic	Parbatipur, P.O. & P.S.: Tamluk, Midnapore (E)	X-Ray & USG
15	Basanti Diagnostic Center	Garkamalpur, P.O. & P.S.: Mahisadal, East Midnapore	Path
16	Bikhan Laboratory	Vill.: Garsabat, P.O. & P.S.: Moyna, Purba Medinipore	path
17	Bikshan (Pathological Laboratory)	Daharpur, P.O. & P.S.: Tamluk, Midnapore (E)	Path
18	Care & Cure	P.O.: Mathchandapur, P.S.: Chandipur, Midnapore (E)	Path
19	Chemico Lanboratory	Rampur, P.O.: Chaitanyapur, P.S.: Sutahata, Midnapore (E)	Path
20	Chena Pathological Laboratory	P.O. & P.S.: Sutahata, Midnapore (E)	Path
21	City Diagnostic Center	Brajanathchak, P.O.: haldia, Purba Medinipore	Path
22	Contai Pahological Research Center	Serpur kharkibar, P.O.: Monoharchak, P.S.: Contai, Midnapore (E)	Path
23	Darpan Pathological Lab	School Bazar, P.O. & P.S.: Contai, Midnapore (E)	Path
24	Deshbandhu Pathological Laboratory	Vill.: Dharinda, P.O. & P.S.: Tamluk, Purba Medinipore	Path
25	Dey's X-Ray & Pathological Laboratory	P.O.: Chaitanyapur, Sutahata, East Midnapore	Path
26	Diagnostic Center (Pathological Laboratory)	Vill.: Santipur, P.O.: Mechada, P.S.: Kolaghat, Midnapore (E)	Path
27	Dishari Pathological Laboratory	Vill. & P.O. & P.S.: Egra, Purba Medinipore	Path
28	Divine Diagnostic Center	Athilagori, P.O. & P.S.: Contai, Midnapore	Path
29	Doctor (Pathological Dept.)	P.O.: Chaitanyapur, Sutahata, East Midnapore	Path

LIST OF DIAGNOSTIC CENTRES BY DISTRICT

Sl. No	Name of the Units.	Address	Services Catered
30	Eco Diagnostic Centre	Vill. & P.O.: Haria, P.S.: Khejuri, Purba Medinipore	Path
31	Edilink Pathological Laboratory	Sudhirdas Sarani, P.O. & P.S.: Contai, Purba Medinipore	Path
32	Egra X-Ray Clinic & Pathological Laboratory	Dalalua, P.O. & P.S.: Egra, Midnapore (E)	Path, X-Ray
33	Green Land Clinic	Terapekhya, Mahishadal, East Midnapore	Path
34	Greenview Diagnostic Center	P.O.: Haria, P.S.: Khejuri, East Midnapore	Path
35	Hatai Medical Diagnostic Center	Bahargram, P.O.: Panskura, East Midnapur	Path
36	Health Care Clinical Laboratory	Vill.: Kakdih, P.O.: Mechada, P.S: Kolaghat, Midnapore (E)	Path
37	Health Care X-Ray Clinic	Pannalaya, Daharpur, Tamluk, East Midnapore	Path
38	ICARE Clinic	Dr. B.R. Ambedkar Bhavan, City Center, Debhog, Haldia, Purba	Path
39	Ideal Pathological Laboratory	P.O.: Sudampur, P.S.: Moyna, East Midnapore	Path
40	Indu X-Ray Clinic & Path Lab.	Debra Bazar, Purba Medinipur	Path
41	Janaki Diagnostic Center	Ramkrishna Bazar, Kalikakhali, Mathchandapur, Midnapore (E)	Path
42	Jeevandeep Clinical Laboratory & Diagnostic Center	Vill.: Machinan, P.O.: Gopalnagar, P.S.: Kolaghat, Purba Medinipore	Path
43	Jeevandeep Pathological Laboratory	P.O.: Sudampur, P.S.: Moyna, East Midnapore	Path
44	Jeevanrekha Diagnostic & Research Center (P) Ltd.	Khanjanchak, Haldia, East Midnapore	Path
45	Joyguru Diagnostic Center	Vill.: Brajalalpur, P.O.: Amashi, P.S.: Patashpur, Midnapore (E)	Path
46	Kiran Diagnostic Center	Udhakhali, P.O.: Haria, O.S.: Khejuri, East Midnapore	Path
47	Life Care Diagnostic Center	Chaltatala, P.O.: Janka, P.S.: Khejuri, East Midnapore	Path
48	Life Diagnostic Center	Basudebpur, Khanjanchak, Durgachak, East Midnapore	Path
49	Life Pathological Laboratory	Vill.: Sankarara, P.O. & P.S.: Tamluk, Purba Medinipore	Path
50	Ma Saradamoyee Laboratory	Bastia, P.O. & P.S.: Egra, Midnapore (E)	Path
51	Maa Diagnostic Laboratory	Vill. & P.O. & P.S.: Bhupatinagar, Purba Medinipore	Path
52	Maa Laboratory	Dharinda, P.O. & P.S.: Tamluk, Midnapore (E)	Path
53	Maa Mamata Pathology	Purusottampur, P.O. Raghunathbari, P.S. Panskura, Midnapore (E)	Path
54	Manju Pathological Laboratory	Gokulchak, P.O.: Jalchak, East Midnapore	Path
55	Manna Laboratory	Daharpur, P.O. & P.S.: Tamluk, Midnapore (E)	Path
56	Medicare Laboratory	P.O. & P.S.: Digha, East Midnapore	Path
57	Medico Pathological Laboratory	P.O.: Basulia, P.S.; Mahishadal, Purba Medinipore	Path
58	Medicure Pathological Diagnostic Center	P.O.: Sudampur, P.S.: Moyna, East Midnapore	Path
59	Medilab Diagnostic & Polyclinic (P) Ltd.	Manjushree Cinema, P.O. Khanjanchak, Durgachak, Midnapore (E)	Path
60	Medilink Pathological Laboratory	P.O. & P.S.: Contai, East Midnapore	Path
61	Medinova Diagnostic Servicing Center	Durgachak, 'A'-Block, P.O. & P.S.: Durgachak, Midnapore (E)	Path
62	Medipath Diagnostic Center	P.O. & P.S.: Sutahata, Midnapore (E)	Path
63	Mediview Pathological Laboratory	Vill.: Daharpur, P.O. & P.S.: Tamluk, Purba Medinipore	Path
64	Medysist Hospital & Research Center (P) Ltd.	Serpur, Etwaribar, P.O. & P.S.: Contai, Purba Medinipore	Path
65	Merry Land Diagnostic Center	School Bazar, P.O. & P.S.: Contai, Midnapore (E)	Path
66	Micro (Pathological Laboratory)	Vill.: Barhadumbasan, P.O. & P.S.: Tamluk, Purba Medinipore	Path
67	Micro Clinical Laboratory	Basudebpur, P.O.: Khanjanchak, P.S.: Durgachak, Midnapore (E)	Path
68	Micro Laboratory	Hatabari, Swaraswatitala, Contai, East Midnapore	Path
69	Micro Vision	P.O.: Nagua School Bazar, P.S.: Egra, East Midnapore	Path
70	Modern Pathological Laboratory	Deulihat, P.O.: Sagareswar, P.S.: Ramnagar, Purba Medinipore	Path
71	Modern X-Ray Clinic	Deulihat, P.O.: Sagareswar, P.S.: Ramnagar, Purba Medinipore	X-Ray
72	Mordern Clinical Laboratory	Basudebpur, P.O.: Khanjanchak, P.S.: Durgachak, Midnapore (E)	Path

LIST OF DIAGNOSTIC CENTRES BY DISTRICT

Sl. No	Name of the Units.	Address	Services Catered
73	Mordern Diagnostic Center	Kumarapur, P.O. & P.S.: Contai, East Midnapore	Path
74	Mordern Diagnostic Center	Sankarara (Hospital More), Tamluk, East Midnapore	Path
75	Mordern Diagnostic Center	Hatishal, P.O.: Keshapat, P.S.: Panskura, East Midnapur	Path
76	Modern Laboratory	Shankara, Badamtala, Tamluk, Dist. East Midnapore.	Path
77	Mother Teresa Nursing Home	Mechogram, Dehati, Dist.Purba Medinipore	Path
78	National X-ray Clinic	Basudebpur, P.O.: Khanjanchak, P.S.: Durgachak, Midnapore(E)	Path
79	New Bargabhima X-Ray & Pathology	Garhmoyna, P.O. & P.S.: Moyna, Midnapore(E)	Path, X-Ray
80	New Bikshan Clinical Laboratory	Hatabari, P.O. & P.S.: Contai, Purba Medinipore	Path
81	New Micro Lab	Bastia, P.O. & P.S.: Egra, Midnapore (E)	Path
82	New Nivedita Laboratory	P.O.: Nonakuri, P.S.: Tamluk, East Midnapore	Path
83	New Oxford Pathological Laboratory	Shibbazar, P.O. & P.S.: Bhagwanpur, Purba Medinipore	Path
84	New Research Laboratory	Santipur, P.O.: Mecheda, P.S.: Kolaghat, Midnapore (E)	Path
85	New Sahayak Pathlab.	Garkamalpur, P.O. & P.S.: Mahisadal, east Midnapore	Path
86	New Spandan X-Ray & Pathology Center	Daharpur, P.O. & P.S.: Tamluk, Midnapore (E)	Path
87	Nirikshan Path Lab	Hatabari, Contai, East Midnapore	Path
88	Nirnayan Pathological Laboratory	P.O. & P.S.: Mahishadal, East Midnapore	Path
89	Nirnay	Bahargram, P.O.: Panskura, East Midnapur	Path
90	Nirnay Diagnostic center	Dalalua, P.O. & P.S.: Egra, Midnapore (E)	Path
91	Paradise Diagnostic & Research Center	Dharinda, P.O. & P.S.: Tamluk, Midnapore (E)	Path
92	Parikshan Clinical Laboratory	Brajalalchak, P.O.: Dakhinchak, P.S.: Bhabanipur, Midnapore (E)	Path
93	Parikshan Laboratory	Terapekhya, Mahishadal, East Midnapore	Path
94	Pasteur Laboratory & Diagnostic	Kalikakhalli, Mathchandapur, Midnapore (E)	Path
95	Pathowind Diagnostic System	HPL Link Road, Khanjanchak, Haldia, East Midnapore	Path
96	Popular X-Ray Clinic	Santipur, P.O.: Mecheda, P.S.: Kolaghat, Midnapore (E)	X-Ray
97	Pradhan Clinical Laboratory	Kalikakhalli, Mathchandapur, Midnapore (E)	Path
98	Prafulla Medical Clinic	Egra, Dist. East Midnapore	Path
99	Raj Pathological Laboratory	Garkamalpur, P.O. & P.S.: Mahisadal, East Midnapore	Path
100	Ramkrishna X-Ray	Kalikakhalli, Mathchandapur, Midnapore (E)	X-Ray
101	Real Diagnostic Center	Barpadumbasan, P.O.: & P.S.: Tamluk, Midnapore (E)	Path
102	Research Pathological Laboratory	3 no. Mini Market, P.O.: Mecheda, P.S.: Kolaghat, Midnapore(E)	Path
103	Rotary Polyclinic Laboratory	Vill.: Kumarapur, P.O. & P.S.: Contai, Purba Medinipore	Path
104	Sarada Pathological Lab.	Talgachhari, P.O. & P.S.: Ramnagar, East Midnapore	Path
105	Scientific Laboratory	Sudhir Bus Road, P.O. & P.S.: Cointai, Purba Medinipore	Path
106	Serobacto Clinicalo Laboratory	Hatabari, P.O. & P.S.: Contai, Purba Medinipore	Path
107	Serum Diagnostic Center	Padmabhusan, P.O. & P.S.: Tamluk, East Midnapore	Path
108	Seva Pathological Laboratory	Serpur, Kharkibar, P.O. & P.S.: Contai, Purba Medinipore	Path
109	Shova Path Lab.	Paramanandapur, P.S.: Mayna, East Midnapore	Path
110	Shyama Clinical Lab.	P.O.: Chaitanyapur, Sutahata, East Midnapore	Path
111	Sova Pathological Laboratory	Kasba, P.O. & P.S.: Egra, Purba Medinipore	Path
112	Sreema Pathology Lab.	P.O.: Kharagpur, Midnapore (E)	Path
113	Sri Krishna X-Ray Clinic	Hatabari, P.O. & P.S.: Contai, Purba Medinipore	Path
114	Supreem Diagnostic Laboratory	Kalikakhalli, Mathchandapur, Midnapore (E)	Path
115	Tamluk Paramedical Tranning Society	Daharpur, P.O. & P.S.: Tamluk, Midnapore (E)	Training Institute
116	The Associate	Salgachhia, P.O. & P.S.: Tamluk, East Midnapore	Path

LIST OF DIAGNOSTIC CENTRES BY DISTRICT

Sl. No	Name of the Units.	Address	Services Catered
117	The New Riverview Diagnostic Center & Clinic	Kola, P.O. & P.S.: Kolaghat, Purba Medinipore	Path
118	Tropico Laboratory	Kumarpur, P.O. & P.S.: Contai, East Midnapore	Path
119	Ultra Sono Diagnostic Center	Salgachhia, P.O. & P.S.: Tamluk, East Midnapore	Path
120	Ultra Sonography Clinic	Hatabari, P.O. & P.S.: Contai, Purba Medinipore	Path
121	Urmila Polyclinic & Diagnostic Center	Serpur, Etwaribar, P.O. & P.S.: Contai, Purba Medinipore	Path
122	Usha Pathology	Salgachhia, P.O. & P.S.: Tamluk, East Midnapore	Path
Numbers of Path Lab: 116 ; Blood Bank: 0 ; Dental Clinic: 0 ; Forensic Lab: 0 ;			
HOOGHLY			
1	A. M. Diagnostic Center & Polyclinic	47/1, Raja Rammohan Roy Sarani, P.O. & P.S.: Serampore,	C.T.Scan
2	Abhijan Eye Care Center	57, Khasbagan Lane, Serampore, Hooghly	Collection Cent.
3	Abishkar Diagnostic Center	Chanditala, Hooghly	Dental
4	Accurate Diagnostic Centre,	Nandi Market, Station Road, Mogra	Dental
5	Active Diagnostic Center	Jagatpur, P.S.: Khanakul, Hooghly	Dental
6	A-D. Scan	Chinsura, Hooghly	Dental
7	Advanced Immuno-Genetic Diagnostic Clinic,	2(178), K.G.R.S. Path, Sonargan Pally, Bhadreswar	Dental
8	Ambee Multicare Clinic	Dongal More, Gourhati, P.O.: Gourhati, P.S.: Arambagh,	Dental
9	Amrita Clinic & Diagnostic Center	28, G. T. Road, Bhadrakali, Uttarpara, Hooghly	E.C.G
10	Analysis	Nirala Apartment, Bidyalanka Road, Chandernagar, Hooghly	Eye
11	Angel Homeo Research Lab. (P) Ltd.	Bhadrakali, Uttarpara, Hooghly	First-Aid Room
12	Anilchandra Clinical Laboratory,	Vill & P.O. Dankuni.	First-Aid Room
13	Animal Planet Veterinary Clinic	19, Library Road (Talikhala), P.O. & P.S.: Chinsura, Hooghly	Ortho-Centre
14	Anindita Diagnostic Point	111, New Park, G. T. Road, Bandel, Hooghly	Ortho-Centre
15	Anonya Diagnostic	1, Amulya Kanan, Serampore, Hooghly	Ortho-Centre
16	Anubikshan Diagnostic Center	Dasghora, P.S.: Dhaniakhali, Hooghly	Path
17	Anwesa	461, G. T. Road, Barabazar, Chandernagar, Hooghly	Path
18	Arambag Diagnostic Center	Taltala Bazar (Near B.K.Roy Super Market), P.O. Arambagh.	Path
19	Arambag X-Ray & Ultrasonography Clinic	Link Road, Near S.B.I. Arambagh, Hooghly	Path
20	Arambagh Phaco Center	Triol Road, Arambagh, Hooghly	Path
21	Arati Clinical Laboratory & Polyclinic,	Vill. & P.O. Begumpur.	Path
22	Arogya Policlinic	Purshura, Hooghly	Path
23	Arogya Sathi Diagnostic Center	Makalpur More, Hooghly	Path
24	Arogyaniketan (P) Ltd.	105, R. S.Verma Road, Uttarpara, Hooghly	Path
25	Asha Physiotherapy Center	Kanailal Pally, Garer Dhar, Chandernagar, Hooghly	Path
26	Ashima Diagnostic Center	1, Rupchand Chaprasi Lane, Kalitala, Serampore, Hooghly	Path
27	Astha Diagnostic Center	Arambagh, Hooghly	Path
28	Astha polyclinic	Mogra Station Road (Katapukur), Magra, Hooghly	Path
29	Atulya Ghosh Memorial Diagnostic Centre,	Vill. & P.O. Jejur.	Path
30	Auckland Pathological Center	Arambagh (Gourhati More), Hooghly	Path
31	B. L. Diagnostic (P) Ltd.	124, B.B.D. Road, P.S.: Hind Motor, Hooghly	Path
32	B.M.C. Diagnostic	Khanka Sarifi Road, Arambagh, Hooghly	Path
33	Bagbazar Doctor's Clinic	Nilkanta Sarkar Street, Chandernagar, Hooghly	Path
34	Balagi Pathological Center	Arambag, Hooghly	Path
35	Bandel Diagnostic Center	Bandel, Hooghly	Path

LIST OF DIAGNOSTIC CENTRES BY DISTRICT

Sl. No	Name of the Units.	Address	Services Catered
36	Bandle X-Ray Clinic	G. T. Road, New Park, Bandle, Hooghly	Path
37	Bangio Physiotherapy Seva Kendra	363, M. G. Road, P.O. & P.S.: Chinsura, Hooghly	Path
38	Bengal Clinical Laboratory	Chanditala, Hooghly	Path
39	Bhadrakali X-Ray Clinic & Medical Center	2, Banerjee Para St. Hooghly	Path
40	Bharati Diagnostic Centre,	Jugipara More, Akhanbazar, Chinsura	Path
41	Bharati Diagnostic Centre,	Bagbazar, Chandernagar	Path
42	Bhattacharjee's Pathological Laboratories	202, Criper Road, P.O. Konnagar.	Path
43	Bidhan Diagnostic	Kayapat, Badangunj, Hooghly	Path
44	Bidisha Diagnostic Center	120, G. T. Road, Bagbazar, Chandernagar, Hooghly	Path
45	Bijay Krishna Saraswati Dental Clinic	15, Vivekananda Road, Bansberia, Hooghly	Path
46	Bimala X-Ray Clinic & Diagnostic Center	Khanakul, Hooghly	Path
47	Bina Diagnostic Center	115/114, New Hospital Road, Chinsura, Hooghly	Path
48	Bio-chem Clinical Laboratory,	50,Raj Krishna Street,P.O. Uttarpara.	Path
49	Birla NGK Insulators (P) Ltd. First-Aid Room	Rishra, P.O.: Prabashnagar, Hooghly	Path
50	Biswas Diagnostic Clinic	143, Station Road, Bhadreswar, Hooghly	Path
51	Biswas Pathological Centre,	Akhanbazar (Opposite Sadar Hospital), P.O. Chinsurah.	Path
52	Blue Veil Diagnostic Services	Chinsura, Hooghly	Path
53	Bombaywala Life Guard Pharmacy & Polyclinic	Bhagawati pur Bazar Road, P.O.: Nawabpur, Hooghly	Path
54	Calcutta Medical Center	15, M.G.M. Sarani, New Laldighi, Chandernagar, Hooghly	Path
55	Care & Cure	70, Dey Street, P.O. & P.S.: Serampore, Hooghly	Path
56	Care & Cure Diagnostic Centre,	S. N. Mallick Road, P.O. Singur.	Path
57	Care Diagnostic Center	Pratappur (Bhajangali), Hooghly	Path
58	Careplus Diagnostic Centre,	43/44, Saratchandra Chatterjee Sarani, Serampore-3.	Path
59	Champdanga Diagnostic Laboratory,	Vill. & P.O. Champadanga.	Path
60	Champdani Diagnostic	27/3, G. T. Raod, Champadani, Hooghly	Path
61	Chandennagar EEG & Diagnostic Center	Golapbag, Chandernagar, Hooghly	Path
62	Chandernagar X-Ray Clinic	G.T. Road, Bara Bazar, Chandernagar, Hooghly	Path
63	Chandernagore Diagnostic Laboratory,	Barabazar, P.O. Chandernagore.	Path
64	Chandernagore X-Ray Clinic	Barabazar, Chandernagar, Hooghly	Path
65	Chanditala Diagnostic Center (P) Ltd.	Barijhaty, P.O. & P.S.: Chanditala, Hooghly	Path
66	Chinmaya Diagnostic & Research Centre,	Mithapukur, P.O. Adconagar.	Path
67	Chinsura Medical Center	Old Hospital Road, Chinsura, Hooghly	Path
68	Chinsura Pathology Center	Chinsura, Hooghly	Path
69	Chinsurah Diagnostic Centre,	Avinandan Apartment, Chinsura	Path
70	Chitra Chahaya Clinic	340, Kanaipur Colony, Kanaipur, Hooghly	Path
71	Chuchura PortableX-Ray Center	44, Hsridham Lane, Akhanbazar, Hooghly	Path
72	Chuchura X-Ray Clinic,	Phulpukur Road, P.O. Chinsurah.	Path
73	City Diagnostic Center	Court Road, Arambagh, Hooghly	Path
74	Clinical Laboratory,	652, G. T. Road, Kalitala, Serampore	Path
75	Clinical Laboratory,	91, Sujan Bagan (Old Hospital Road), Chinsura, Hooghly	Path
76	Consulting Clinical Pathology	10/B, A.K..C. Bhatteejee St. Serampore, Hooghly	Path
77	Cure Diagnostic Center	Sree Ramkrishna Bhawan, G. T. Road, Hooghly	Path
78	Cure Patholab.	Bagbazar, Chandernagar, Hooghly	Path
79	Daisy Diagnostic Centre,	15, Deshbandhu Road, B, Block, P.O. Nabagram.	Path

LIST OF DIAGNOSTIC CENTRES BY DISTRICT

Sl. No	Name of the Units.	Address	Services Catered
80	Damodar Diagnostic Clinic & Research Centre,	Pallishree, P.O. Arambagh.	Path
81	Damodar Jeeu Medical Laboratory	P.O. & P.S.: Arambagh, Hooghly	Path
82	Dankuni Medical Centre,	Monohar Pur, (East), S. S. Pally, P.O. Dankuni.	Path
83	Das Clinic,	19, S.C.Deb Lane, P.O. Konnagar.	Path
84	Dasghora Pathological Centre,	Vill. & P.O. Dasghora.	Path
85	Dasghora X-Ray Clinic	Dasghora, P.S.: Dhaniakhali, Hooghly	Path
86	Dasgupta E. C. G. Clinic	Vidyasagar Road, Nabagram, Bara Bahar, Rishra, Hooghly	Path
87	Dasgupta Valorem clinic,	55, Bandel Station Road, Bandle	Path
88	Data Diagnostics, Gupta Shopping Complex,	Govt. Housing, Dankuni.	Path
89	Debabrata Medicare & Diagnostic Center	Nabagram, Hooghly	Path
90	Debsishu Diagnostic Center	Chaupathy, T. C. Road, Tarakeswar, Hooghly	Path
91	Deepa Diagnostic	New Hospital Road, Chinsura, Hooghly	Path
92	Dental Clinic,	Hospital Road, P.O. Chinsurah.	Path
93	Dey's Clinical Laboratory	Rajbalhat, Hooghly	Path
94	Diagnostic Research Centre,	Taltala Bazar (Near B.K.Roy Super Market), P.O. Arambagh.	Path
95	Diagnosics	Burabazar, Chandernagar, Hooghly	Path
96	Dinabandhu Diagnostic Center	Mogra, Hooghly	Path
97	Doctor's Diagnostic Center	21, Charakdanga Road, Uttarpara	Path
98	Doctor's, Lab	48, S.C.M Road, Sheoraphuli.	Path
99	Doctor's Clinic	Chandernagar, Hooghly	Path
100	Doctor's Diagnostic Center	Jirat Bus Stand, Balagarh, Hooghly	Path
101	Doctor's Diagnostic Center	Dhaniakhali, Cinematola, Hooghly	Path
102	Doctors' Laboratory,	Court Road, Bus Stand, P.O.-Arambagh.	Path
103	Dolphin Pathological Laboratory	31A, Gandhi Sarak, Rishra, Hooghly	Path
104	Dr. A. K. Dasgupta pathological Laboratory	Netaji Subhas Road, Chinsura, Hooghly	Path
105	Dr. Alok Ray Chaudhuri Orthopedic Clinic	Amantran, Palpara Road, Chandernagar, Hooghly	Path
106	Dr. Arijit Ghosh Dental Clinic	Sportview Apartment, Tunu Mukherjee Sarani, Chandernagar,	Path
107	Dr. Arup Kumar Bose,	Barabazar, Duttalodge, Chinsura	Path
108	Dr. Bhaskar Das Orthpedic Clinic	Gopalbag, Chandernagar, Hooghly	Path
109	Dr. D.K. Mandal's Laboratory,	2/D, Mahatma Gandhi Road, Serampore	Path
110	Dr. Deboprasad Ghosh-Dental Clinic	3, Charu Chandra Roy Road, Bagbazar, Chandernagar,	Path
111	Dr. Dilip Kr. Das - Dental Clinic	Laxmigaunj Bazar, P.O.: Chandernagar, Hooghly	Path
112	Dr. Dinobandhu Diagnostic Centre,	Mogra Tribeni Road, P.O. Mogra.	Path
113	Dr. Dutta's Clinic	Barabazar, Chandernagar, Hooghly	Path
114	Dr. Gopal Das Nag Memorial Unit	58, Rishi Bankim Sarani, Battala, Serampore, Hooghly	Path
115	Dr. Nirmal Kr. Halder Laboratory	Chinsura, Hooghly	Path
116	Dr. Roy's Pathological Laboratory	Burra Bazar, Chandernagar, Hooghly	Path
117	Dr. S.K. Maiti-Dental Clinic	Station Road, Bagbazar, Chandernagar, Hooghly	Path
118	Dr. Sandip Banerjee-Dental Clinic	Apanjan, Nibedita Sarani, Station Road, Chandernagar,	Path
119	Dr. Sarkar Pathological Laboratory & Diagnostic Center	100/1, T. N. Mukherjee Road, Makhla, Maniktala, Hooghly	Path
120	Dr. Sipra Ray Chaudhury Gynochologist / Obstetrician	Amantran, Palpara Road, Chandernagar, Hooghly	Path
121	Dr. Tarak Chandra Ghosh, (X - Ray Clinic	J.N. Chowdhury Road, Chinsura	Path
122	Dristi Eye Care & Medical Center	P.O. & P.S.: Mogra, Hooghly	Path
123	Drug House Dioagnostic Center	48A, Dey Street, P.O.: Serampore, Hooghly	Path

LIST OF DIAGNOSTIC CENTRES BY DISTRICT

Sl. No	Name of the Units.	Address	Services Catered
124	Drug House Dioagnostic Center	2No., Ganendra Avenue, Uttarpara, Hooghly	Path
125	Drughouse Diagnostic Center	Mainak Abasan, Tarakeswar, Hooghly	Path
126	Duce Diagnostic Centre,	P.O. Arambagh.	Path
127	Dynamic Investigation Centre,	50, Shibtala Street, P.O. Uttarpara.	Path
128	Dynamik Diagnostic Center	141 (11), Birla Road, Makhla, P.S.: Uttarpara, Hooghly	Path
129	Eko Ultra	Doctor Bagan Lane, Hooghly	Path
130	Eureka Diagnostic Centre,	117/1, J.C. Khan Road, Mankundu	Path
131	Florida Health Care & Research Center	Baidyabati, Hooghly	Path
132	G. C. Diagnostic Center	Vill. & P.O.: Sodepur, P.S.: Pursurah, Hooghly	Path
133	G. D. Pahtological Laboratory	Konnagar, Hooghly	Path
134	G.D. Diagnostic Centre,	Mogra Amodghati, P.O. Mogra.	Path
135	Gajar More Poly Clinic,	Vill. Gajar More, P.O. Dalapatipur.	Path
136	Ganga Pathological Laboratory,	Vill. Krishnannagar, P.O. Jangipara.	Path
137	Ganguly Clinic	4C, Padmapukur, Tarakeswar, Hooghly	Path
138	Ghosh Clinical Laboratory,	Hospital Road, Super Market, Stall No. - 27, Arambag	Path
139	Ghosh's Dental Clinic & Laboratory,	"Ganga-Darshan". 4. Raja K.L. Goswami Street, Serampore.	Path
140	Green Land Medical Center	Harit, Dadpur, Hooghly	Path
141	Green View Clinical Laboratory,	Vill. & P.O. Borai.	Path
142	Guide Polyclinic & Diagnostic Centre,	G.T. Road, Bandel.	Path
143	Gurap X-Ray Clinic	Gurap Bazar, Hooghly	Path
144	Halder Polyclinic	Janai Raod, Chikrand, Hooghly	Path
145	Happy Clinic,	3, Old Court Lane, Serampore.	Path
146	Haripal Medical Services	Haripal , Hooghly	Path
147	Haripal Mordern Diagnostic Center	P.O. & P.S.: Haripal, Hooghly	Path
148	Haripal Pathological Clinic,	P.O. Khamarchandi.	Path
149	Haripal Poly Clinic,	Haripal Station Road, Haripal, Hooghly	Path
150	Hazipur Diagnostic Center	Goghat, Hooghly	Path
151	Health Care (Polyclinic, Pathology, X-Ray & Imaging)	S.P.Mallick Road, Satmandirtala, P.O. & P.S.: Singur,	Path
152	Health Care Diagnostic Center	Link Road, Arambagh, P.O. Arambagh., Hooghly	Path
153	Health Care Polyclinic & Diagnostic Center	49/4A, Rabindra Sarani, Rishra, Hooghly	Path
154	Health Care,	136/1, Rajendra Avenue, Uttarpara	Path
155	Health Point	T. C. Road, Padma Pukur, Hooghly	Path
156	Health View Ployclinic Diagnostic Center	Monoharpur (East), Dankuni, Hooghly	Path
157	Hooghly Pathology Centre,	Pratappur, Old Hospital Road, Chinsura	Path
158	Ilsoa Jnan Seba Kendra	Ilsoa-Mondlai, Hooghly	Path
159	Image	26, S. C. Mukherjee Road, Konnagar, Hooghly	Path
160	Indian Rayon (Unit of Jayashree Textiles) First Aid	Rishra, P.O.: Prabashnagar, Hooghly	Path
161	Ivy Clinic	Old Hospital Road, Chinsura, Hooghly	Path
162	Janakalyan Patho Lab	S. N. Mallick Road, Singur, Hooghly	Path
163	Janakalyan Scientific Laboratory,	27, R.N. Neogi Lane, Bhadreswar	Path
164	Janakalyan X-Ray Clinic	Bionchi, P.S.: Panduah, Hooghly	Path
165	Janaseva X-Ray Clinic	Singur, Hooghly	Path
166	Jangipara Clinical Laboratory,	Meghamala Bhawan, P.O.Jangipara, Hooghly	Path
167	Janiva Diagnostic Center	Champadanga, Tarakeswar, Hooghly	Path

LIST OF DIAGNOSTIC CENTRES BY DISTRICT

Sl. No	Name of the Units.	Address	Services Catered
168	Jeevandeep Seva Sadan	Kamarkundu, Singur, Hooghly	Path
169	Jharna Diagnostic Center & Polyclinic	Ramnagar, P.O. & P.S.: Khanakul, Hooghly	Path
170	Jibak Polyclinic	1B, Desh Bandhu Road, Nabagram, Hooghly	Path
171	Jiban Central Clinical Pathological Laboratory	Binodini Villa, Arambagh, Hooghly	Path
172	Jiban Central Laboratory,	Arambagh, P.O. Arambagh.	Path
173	Jivandeep Pathological Laboratory	Badangunj, Hooghly	Path
174	Jivandeep X-Ray Clinic	Badanganj, Goghat, Hooghly	Path
175	Joystna Diagnostic	Bhadreswar, Hooghly	Path
176	Jyotirmoyee Arogya Bhawan	Vill. & P.O.: Sheakhala, Hooghly - 710 706	Path
177	K. M. X-Ray Clinic	Old Hospital Road, Chinsura, Hooghly	Path
178	Kalpana X-Ray Clinic & Pathological Center	Deulpara, Hooghly	Path
179	Kalpataru Pathological Laboratory,	G.T. Road, Samanta Goli, Pandua	Path
180	Kalyan Path Lab	Birla Road, Near Baro Shib Mandir, Shastri Nagar, Barabahaera,	Path
181	Kamala X-Ray Clinic & Diagnostic Center	Jangipara Hospital Road, Hooghly	Path
182	Kanak Seba Sadan	Gourhati Raod, Arambag, Hooghly	Path
183	Kanak SurjA X-Ray Clinic	Pallishree, Arambag, Hooghly	Path
184	Kiran Diagnostic Center	204, Indira Gandhi Road, Hooghly	Path
185	Konnagar Poly Clinic,	208, Cripur Road, P.O. Konnagar.	Path
186	Kum Kum Immuno Diagnostics,	138, N.S. Road, P.O. Uttarpara.	Path
187	Laha Polyclinic	Begampur, Hooghly	Path
188	Life Care Clinical Laboratory,	Boinchi, Hooghly	Path
189	Life Care Polyclinic & Pathological Laboratory,	Vill. & P.O. Jangipara.	Path
190	Life Line Diagnostic Centre,	Benepukur Road, Nutan Bazar, P.O. Arambagh.	Path
191	Life Line Diagnostic Centre,	Joy Krishna Bazar, Tarakeswar, Hooghly	Path
192	Life Line Diagnostic Centre,	Tematha, Chandernagar, Hooghly	Path
193	Lokenath X-Ray Clinic	Rishra, Hooghly	Path
194	Loknath Poly Clinic	156, S. C. Chatterjee St. Konnagar, Hooghly	Path
195	Loknath X-Ray & Diagnostic Center	172/2, Gopal Bag, Satyapirtala, Chandernagar, Hooghly	Path
196	M.C. Pathological Laboratory,	41, Netaji Subhas Avenue, Serampore	Path
197	Magra X-Ray Clinic	Mogra Station Road (Katapukur), Magra, Hooghly	Path
198	Mahamilon Seva Trust	Arambagh, Gourhati More, Hooghly	Path
199	Maitreye Ultra Sonic Centre,	Sujan Bagan, Old Hospital Road, P.O. Chinsurah.	Path
200	Mamta Diagnostic & polyclinic	49, A. Dey Street, Battala, Serampur, Hooghly	Path
201	Maternity & Diagnostic Clinic,	73, Ferry Ghat Street, Babur Bazar, Telenipara, Bhadreswar	Path
202	Medi Lab,	Vill.- Dhaniakhali, Cinematala, Dhaniakhali	Path
203	Medi Path Diagnostic Center	Khanakul, Hooghly	Path
204	Medi Span Diagnostic Center	Konnagar, Hooghly	Path
205	Medi-Aid Diagnostic Center	Barijhati, Chanditala, Hooghly	Path
206	Medicare Clinic & Laboratory,	Link Road, P.O. Arambagh.	Path
207	Medicare Diagnostic & Polyclinic	169, KGRS, Bhadreswar, Hooghly	Path
208	Medicare Pathological Laboratoty,	Vill. & P.O. Baruipara. Singur	Path
209	Medilab Diagnostic	Park View, Kuthirmath West, Bagbazar, P.O. Chandannagore.	Path
210	Medilab Diagnostic & Research Centre,	P.O. Dankuni.	Path
211	Medilab Diagnostic Centre,	85/9, G. T. Road, Serampore, Hooghly	Path

LIST OF DIAGNOSTIC CENTRES BY DISTRICT

Sl. No	Name of the Units.	Address	Services Catered
212	Mediland Diagnostic Center	Daulat Bazar, Tribeni, Hooghly	Path
213	Mediland Diagnostic Center	Parul Kanan, Dankuni, Hooghly	Path
214	Medinova Collection Center	Swapnabazar, P.O. Chandannagar.	Path
215	Medisearch Pathological Laboratory	Bajua, Hooghly	Path
216	Meditek Center	Durgacharan Rakhit Road, Sridurga More, Chandernagar,	Path
217	Meditest Clinical Laboratory,	Vill. Muthadanga, P.O. Mayapur.	Path
218	Mediview Pathology & Polyclinic	Barabazar, S. C. Rakshit Road, Chandernagar, Hooghly	Path
219	Medivision Diagnostic Center	Garalgzcha, Chanditala, Hooghly	Path
220	Micro Pathological Laboratory,	75A, Ghosh Para Lane, Bhadrakali	Path
221	Microvision Diagnostic Centre,	Swapnabazar, Mankundu Station Road, P.O. Chandannagar.	Path
222	Mile Stone Clinic	93 Old Hospital Road, Sugan Bagan, Chinsura, Hooghly	Path
223	Mile Stone Clinic (X-Ray)	Chandernagar, Hooghly	Path
224	Mitra Diagnostic Centre,	Chawk Bazar, P.O. Hooghly.	Path
225	Modern Laboratory	Vill & P.O.: Balipur, P.S.: Khanakul, Hooghly	Path
226	Modern Diagnostic Centre,	Rishra, Hooghly	Path
227	Modern Diagnostic Centre,	1/1, Bazar Lane, P.O. Uttarpara.	Path
228	Modern Diagnostic Centre,	(Bhadreswar), 48, G.T.Road, Tentultala, P.O. Bhadreswar.	Path
229	Modern Pathological Laboratory,	200/B, Gourhati More, P.O. Arambagh.	Path
230	Modern Pathological Laboratory,	Samata Gali, G.T.Road, P.O. Pandua.	Path
231	Mondal Diagnostic Centre,	Natungram, Mogra-Khanpur Road, P.O. Mogra.	Path
232	Mordern X-Ray Clinic	Jangipara (Natun Pally), Hooghly	Path
233	Mordern X-Ray Clinic	Moshat Bazar, Hooghly	Path
234	Mugdha Polyclinic & Doctor's Chamber	T. N. Mukherjee Road, Kalipur, Garalgacha, Hooghly	Path
235	Mujadded Charitable Dispensary,	Vill. Par-Harinkhola, P.O. Harinkhola, Arambagh	Path
236	Mukherjee Diagnostic Center	Dabpur, Hooghly	Path
237	Nabajeeban Pathological Laboratory,	Vill & P.O.: Ballypore, P.S. Khanakul, Hooghly	Path
238	Nabarun Clinical Laboratory,	Pallishree, P.O. Arambagh.	Path
239	Nalikul Path Center	Nalikul Bus Stand, Nalikul, P.S. Haripal, Hooghly	Path
240	Narayan Clinic (X-Ray),	Station Road, P.O. Dankuni.	Path
241	Narayan Pathological Laboratory,	Vill. & P.O. Jangalpara Bazar.	Path
242	Narcissus Medical Center (P) Ltd.	Vill & P. O.: Pursura, Arambagh Hooghly	Path
243	Narcissus Radiological Centre,	12, Dr. G.C. Goswami Street, Serampore, Hooghly	Path
244	National Diagnostic Center	Rajhati Bhandar, Khanakul, Hooghly	Path
245	New Chychra Pathological Center	Chinsura, Hooghly	Path
246	New Life Diagnostic Centre,	Urdibazar, Chandannagar.	Path
247	New Life Pathological Center	Boinchi, Hooghly	Path
248	New Life Polyclinic & Diagnostic Center	49/52/1, N. K. Banerjee St. Rishra, Hooghly	Path
249	New Life Sonoscan Centre,	New Hospital Road, (Sadar Hospital Main Gate), Chinsurah.	Path
250	New Nivedita Diagnostic Services	M.G.M. Sarani, Talpukur, Baghbazar, Hooghly	Path
251	New Pathological Center	P.O.: Boinchi, Hooghly - 712134	Path
252	New Pathology Centre,	Bagbazar, Kalibari More, Chandernagar	Path
253	New Poly Clinic	Bagbazar, Nilkanta Sarkar St.Chandernagar, Hooghly	Path
254	New Scientific Clinical Laboratory	Khanakul, Hooghly	Path
255	New United Diagnostic Clinic	Bara Bazar Main Road, Chandernagar, Hooghly	Path

LIST OF DIAGNOSTIC CENTRES BY DISTRICT

Sl. No	Name of the Units.	Address	Services Catered
256	New X-Ray Clinic	Nilkanta Sarkar Street, Chandernagar, Hooghly	Path
257	Nibedita Diagnostic Center & Polyclinic	Nilkanta Sarkar Road, Chandernagar, Hooghly	Path
258	Night Angel X-Ray Clinic	Link Road,, Arambag, Hooghly	Path
259	Nilima Matrisadan	22, Shibsankar Road, Uttarpara, Hooghly	Path
260	Nilkanta Diagnostic & Research Centre,	B.T.C. Road, P.O. Tarakeswar.	Path
261	Nilratan Pathological Laboratory	Khanakul, Hooghly	Path
262	Nirala X-Ray Clinic	New Hospital Road, P.O. & P.S.:Chinsura, Hooghly	Path
263	Niramoy Pathological Laboratory,	Nutan Bazar Bus Stand, P.O. Arambagh, Hooghly	Path
264	Nirikhnan Clinical Laboratory	Hospital Road, Arambagh, Hooghly	Path
265	Nirikshan Clinical Laboratory	Dakshin Narayanpur, P.O.: Narayanpur, Arambagh, Hooghly	Path
266	Nirnay Pathological Laboratory,	S.N. Mallick Road, Singur Bazar 1st Floor, Singur	Path
267	Nirnay X-Ray Clinic	Janai Raod, Hooghly	Path
268	Nirnaya	Khajurdah Nabnkur United Club, Khajurdah, Hooghly	Path
269	Nirnoy Pathological laboratory	353, S. N. Mallick Raod, 1st floor Singur	Path
270	Nirnoy,	Peara Bagan, P.O. Hooghly.	Path
271	Nirog Diagnostic	Arambagh (Court Road), Hooghly - 712601.	Path
272	Nivedita Diagnostic Center	Akhan Bazar, Chinsura, Hooghly	Path
273	NMB Diagnostics	Mahesh, Serampore, Hooghly	Path
274	Osh White Medical Center	Prabhas Nagar, Rishra, Hooghly	Path
275	Pal Pathology Centre,	Pratappur, Old Hospital Road, Chinsura	Path
276	Pandua Pathological Laboratory,	Hattala, G.T.Road, Pandua.	Path
277	Pandua X-Ray Clinic	G. T. Road,Pandua, Hooghly	Path
278	Pankajini X-Ray Clinic	Dankuni, Hooghly	Path
279	Pariksha Diagnostic Center	Sarada Pally, Tarakeswar, Hooghly	Path
280	Parikshan	Diara, Hooghly	Path
281	Pariseba	Khanakul, Hooghly	Path
282	Park Diagnostics	30A/162, Dr. P. T. Laha St. Rishra, Hooghly	Path
283	Park Medicare & Research Centre (P) Ltd.,	30A/148, Dr. P.T. Laha Street, Rishra	Path
284	Park Poly Clinic	Green Park (South), G. T. Raod, Bandel, Hooghly	Path
285	Pasteured Diagnostic Center	Naskarpur, Champadanga, Hooghly	Path
286	Pastur Pathology	Akhan Bazar, Hori Dham Goli, Hospital Road, Chinsura, Hooghly	Path
287	Patho –O-Lab Medical Centre,	230, N.C. Ghosh Sarani, Sheoraphuli	Path
288	Pathological Center	Nilkanta Sarkar Street, Chandernagar, Hooghly	Path
289	Pathological Laboratory & X-Ray Clinic,	78, F.G. Street, P.O. Telinipara, Hooghly	Path
290	Pathological Laboratory,	750, G.T.Road (W), Barabazar, Chandernagar	Path
291	Pioneer Medical & Service Center Clinic	1st Floor Matara Market, 5, Bhadreswar Station Road, Hooghly	Path
292	Popular Clinical Laboratory,	6, K.C. Sen Road (Main), Morepukur, Rishra	Path
293	Pursurah Diagnostic Laboratory,	Vill. & P.O. Pursurah.	Path
294	Radha Rani Ultra Scan,	Vill. Bhadurpur, P.O. Belmuri, Daniakhali.	Path
295	Radiogenesis	55, Beni Banerjee Lane, Baidyabati, P.O. Sheoraphuli.	Path
296	Raj Laboratory & Polyclinic	Arambagh, Hooghly	Path
297	Raj Rajeshwar Medical Clinic & Diagnostic Centre,	15/42, Lenin Sarani, Mallick Para, Serampore.	Path
298	Rajhati pathological Clinic	Khanakul, Rajhati Bandar, Hooghly	Path
299	Ramkrishna Clinical Lab	Konnagar, Hooghly	Path

LIST OF DIAGNOSTIC CENTRES BY DISTRICT

Sl. No	Name of the Units.	Address	Services Catered
300	Ramkrishna Mission Pallimangal	Kamarpukur, Hooghly	Path
301	Ramkrishna Pathological Lab & X-Ray Clinic	Champadanga, Tarakeswar, Hooghly	Path
302	Ramkrishna Ultra Sound Scan Center	Arambag, Hooghly	Path
303	Ramkrishna X-Ray Clinic	Arambag, Hooghly	Path
304	Rampara Beharilal Dey Charitable Dispensary	Rampara, Dakshindihi, Jangipara, Hooghly	Path
305	Regional Diagnostic (Belongs to Municipality)	G. T. Road, Telenipara, Hooghly	Path
306	Remit	N-1/A, C.S. Mukherjee Bye Lane (North), P.O.: Konnagar,	Path
307	Renuka Poly Clinic and Diagnostic Centre,	Vill. & P.O. Bora.	Path
308	Rishra Medical Service,	9/4 K. C. Sen Road, P.O.: Morepukur, Rishra, Hooghly	Path
309	Rog Nirnoy Kendra,	55, Beni Banerjee Lane, Baidyabati, P.O. Sheoraphuli.	Path
310	Rotary Club of Chandernagar (Health Care Unit)	Bhadreswar, Hooghly	Path
311	Rotary Club of Hooghly Welfare Trust,	61, Hanseswari Road, P.O. Bansberia	Path
312	Royal Clinical Laboratory	Nayasarai, Hooghly	Path
313	Royal Diagnostic Center	Chinsura, Hooghly	Path
314	Royal X-Ray Clinic	Samata Gali, G.T.Road, P.O. Pandua.	Path
315	Roy's Clinical Laboratory	Barabazar, Chandernagar, Hooghly	Path
316	S. J. Diagnostic Center	Majher Golapara, P.O.: Angus, Hooghly	Path
317	Sabyasachi Diagnostic Center	Krishnagar, Arambag, Hooghly	Path
318	Samui Seva Sadan	Vill & P.O.: Nandanpur, P.S.: Khanakul, Arambagh, Hooghly	Path
319	Sandhya Medipath with Polyclinic,	89/53, Bangur, 2nd Lane, P.O. Rishra, Hooghly	Path
320	Sanjeeban Diagnostic Clinic	Latbagan, P.O: Sahagunj, Hooghly	Path
321	Santra Pathological Laboratory,	Vill. Barijahati, P.O. Chanditala.	Path
322	Sarada Clinicare System	86, Rash Behari Avenue, Station Road, Fatakgora, Chandernagar,	Path
323	Sarada Diagnostic Center	T. C. Road, Jpadmapukur, Tarakeswar, Hooghly	Path
324	Sarada X-Ray Clinic	Kamarkundu, Hooghly	Path
325	Scientific Diagnostic & Research Centre,	Kamarkundu Nutan Bazar, Kamarkundu	Path, X-Ray
326	Scientific Pathological Laboratory,	Vill. Dihibatipur, P.O. Alati.	Path, X-Ray
327	Scientific Pathological Laboratory,	23, New G.T.Road, Uttarpara.	Path, X-Ray
328	Scientific Pathological Laboratory,	4/2, Shibtala Street, Uttarpara, Hooghly, Hooghly - 712 258	Path, X-Ray
329	Scientific Pathological Laboratory,	Tokipur, Nimdingi, Arambag, Hooghly	Path, X-Ray
330	Seba Diagnostic Center & Polyclinic	Monohar Pur, (East), S. S. Pally, P.O. Dankuni. Hooghly	Path, X-Ray
331	Sebayan	Room No.: 8 & 9, Panchyat Bhawan, Vill & P.O.: Uttarpara,	Path, X-Ray
332	Sebayan Pathology	Khanyan Station Road, Khanyan, P.S. Pandua, Hooghly	Path, X-Ray
333	Sebayan Polyclinic	Dhaniakhali, Hooghly	Path, X-Ray
334	Sebayan X-Ray Clinic	P.O.: Polba, Hooghly	Path, X-Ray
335	Sensitive Diagnostics,	Rathersarak, Sombola- Shibtala, Chandernagar	Path, X-Ray
336	Serampore Medical & Diagnostic Centre,	12, Dr. G.C. Goswami Street, Serampore	Path, X-Ray
337	Serampore Medical & Diagnostic Centre,	Serampore, Hooghly	Path, X-Ray
338	Serampore Pathological Laboratory,	5, Rajendra Bag Road, Serampore	Path, X-Ray
339	Serampore Treatment Center	81, G. T. Road, Serampore, Hooghly	Path, X-Ray
340	Serampur Radiological Clinic	627, G.T. Road, Serampur, Hooghly	Path, X-Ray
341	Seva Diagnostic & Research Clinic	30A, T. C. Goswami Street, Serampore, Hooghly	Path, X-Ray
342	Seva Hospital X-Ray Clinic	T. C. Road, Joy Krishna Bazar, Tarakeswar, Hooghly	Path, X-Ray
343	Seva Pathology Center	Pandua, Hooghly	Path, X-Ray

LIST OF DIAGNOSTIC CENTRES BY DISTRICT

Sl. No	Name of the Units.	Address	Services Catered
344	Sevayan (N) X-Ray Clinic	Nalikul Station Bazar, Nalikul, P.S. Haripal, Hooghly	Path, X-Ray
345	Sevayan Pathological Laboratory	Arambagh, Hooghly	U.S.G
346	Sevayan X-Ray Clinic	Station Road, Singur, Hooghly	U.S.G
347	Sevayatan (Patho- Lab),	Ratanpur-II, P.O. Singur.	U.S.G
348	Shanti Scan Center	61/1/A, Rajmohon Road, Uttarpara, Hooghly	U.S.G
349	Shanti Scan Center	61/1/0, Rajmohan Road, Uttarpara, Hooghly	U.S.G
350	Shekhala Medical Center	Shekhala Bazar, Hooghly	U.S.G
351	Shekhala Medical Center & X-Ray Clinic	Shekhala Bazar, Hooghly	U.S.G
352	Sheoraphully Bacto Clinical Laboratory,	16/1, Goswami Bagan Lane, Sheoraphuli	U.S.G.
353	Sheoraphully Diagnostic Center	Sheoraphully, Hooghly	U.S.G.
354	Sheraphully X-Ray Clinic,	16/1, Goswami Bagan Lane, Sheoraphully	Veterinary
355	Shine & Smile Dental Clinic	124, BBD Road, P.O.: Hindmotor, Hooghly	X-Ray
356	Shri Guru Diagnostic Center	Gurap, Barabazar Road, Hooghly	X-Ray
357	Shyamoli Clinical Laboratory,	17, Santinagar Road, P.O. Bhadrakali	X-Ray
358	Sibani Pathological Laboratory	Paschimpara, Nimdangi, Pursura, Hooghly	X-Ray
359	Singur Seva Sadan	Sat Mandirtala, Singur, Hooghly	X-Ray
360	Sonamoni X-Ray Clinic	Hospital Road, Jirat, Vill. Ahmedpur, P.O. Patuligram.	X-Ray
361	Spandan Diagnostic Center	Link Road, Arambag, Hooghly	X-Ray
362	Speciality Diagnostics	Bagbazar, Chandernagar, Hooghly	X-Ray
363	Sree Krishna Polyclinic	P.O.: Baruipara, P.S.: Singur, Hooghly	X-Ray
364	Sree Ram Pathology Center	Sujan Gali, Chinsura, Hooghly	X-Ray
365	Sriguru Diagnostic Center	Konnagar, Hooghly	X-Ray
366	Star X-Ray Clinic & Diagnostic Center	Balidaha, Gurap, Hooghly	X-Ray
367	Su Swasthya Pathological Laboratory	Circus maidan, Gourhati More, Arambag, Hooghly	X-Ray
368	Subarban Sono Clinic	85, A. K. Dutta Sarani, Sakher Bazar, Bhadrakali, Hooghly	X-Ray
369	Suchetana Diagnostic	87B / 15, G. T. Road (West), Serampore, hooghly	X-Ray
370	Sukla X-Ray Clinic,	Barabazar, P.O. Chandernagar.	X-Ray
371	Sumangal Polyclinic	Mankundu Station Road, Chandernagar, Hooghly	X-Ray
372	Sun Diagnostics,	447/2, G.T. Road, Lichutala, P.O. Chandannagar	X-Ray
373	Sunayan Eye Clinic & Micro Surgery Center	32, B.N.N.S. Sarani, Uttarpara, Hooghly	X-Ray
374	Sunimoy Diagnostic Center	Das Super Market, Pandua, Hooghly	X-Ray
375	Suraksha Diagnostic Center	Bhandarhati, Dhaniakhali, Hooghly	X-Ray
376	Suraksha Pathological Laboratory	Baligori, P.S.: Tarakeswar, Hooghly	X-Ray
377	Sure & Cure Diagnostic Center	Helan, Khanakul, Hooghly	X-Ray
378	Sushma Diagnostic Center	P.O.: Guptipara, P.S.: Balagarh, Hooghly	X-Ray
379	Swagata Scientific Laboratory	T. C. Road, Padmapukur, Tarakeswar, Hooghly	X-Ray
380	Swamiji X-Ray Clinic	Sigur Bazar, Singur, Hooghly	X-Ray
381	Swasti Diagnostic Laboratory	Alinagar, P.O.: Kaswara, Hooghly	X-Ray
382	Swasti X-Ray & Laboratory	Sheoraphully, Hooghly	X-Ray
383	Sweta Clinic	77/C, N. C. Banerjee Road, Baidyabati, P.S.: Serampore,	X-Ray
384	Tapan Kr. Banerjee (Pathological Laboratory),	G.T. Road, Barabazar, Chandernagar	X-Ray
385	Tara Pathology	Khanpur, Hooghly	X-Ray
386	Tarakeswar Diagnostic Clinic,	Tarakeswar Choulpatty, P.O.: Tarakeswar, Hooghly	X-Ray
387	Tarakeswar Ultrascan	Choulpatty, Tarekeswar, Hooghly	X-Ray

LIST OF DIAGNOSTIC CENTRES BY DISTRICT

Sl. No	Name of the Units.	Address	Services Catered
388	Taraknath Pathological Laboratory,	G.T. Road (Debidastala), Rabindranagar.	X-Ray
389	Taraknath Pathological Laboratory,	Padmapukur, P.O. & P.S.: Tarakeswar, Hooghly	X-Ray
390	Tentultala X-Ray Clinic	Champadanga, Tarakeswar, Hooghly	X-Ray
391	Teresa Medical Center	Arambagh Hospital Road, P.O.: Arambagh, Hooghly	X-Ray
392	The Bacto Clinical Laboratory,	184, B.B.D. Road, P.O. Hindmotor.	X-Ray
393	The Cure Investigation Centre,	Vill. & P.O. Kamarkundua.	X-Ray
394	The Laboratories,	Hospital Road, Jirat, Vill. Ahmedpur, P.O. Patuligram.	X-Ray
395	The Life Pathological diagnostic Center	Hospital road, Chinsura, Hooghly	X-Ray
396	The Meditech	Akhanbajar, Hooghly	X-Ray
397	The Nabajeeban Clinical Laboratory,	Natun Bazar, P.O. Arambagh.	X-Ray
398	The New Life Polyclinic	Nilkantaz Sarkar Road, Chandernagar, Hooghly	X-Ray
399	The New Nursing Home (Pathological & X-Ray Unit),	Bagbazar (Kalibari), Chandernagar	X-Ray
400	The Nirikshan Clinical Laboratory	Arambagh, Hooghly	X-Ray
401	The Pathological Laboratory	G. T. Road, Chandernagar, Hooghly	X-Ray
402	The Poly Clinic (Dr. Hari Mohan Kundu),	Gourhati More, P.O. Arambagh.	X-Ray
403	The Raj Research Laboratory	Rajbati Bandar, Khanakul, Hooghly	X-Ray
404	Tirupati Ultrascan	Arambagh, Hooghly	X-Ray
405	Tribeni Medical Center	Tribeni, Hooghly	X-Ray
406	Tribeni Patho Lab	99, Daulat Bazar, Tribeni, Hooghly	X-Ray
407	Ultimate Diagnostic Centre,	Jirat Station Road, Vill. Hasimpur, Balagarh	X-Ray
408	United Diagnostic Clinic	Barabazar, Chandernagar, Hooghly	X-Ray
409	United Pathology & Diagnostic Center	89/93, Bangur 3rd Lane, P.O.: Rishra, Hooghly	X-Ray
410	United X-Ray Clinic	Pandua, Hooghly	X-Ray
411	Upasana Health & Medicare Center	Sujan Bagan, P.O. Chinsurah.	X-Ray
412	Uttarpara Eye Care	44, Bafar Lane, P.O.: Uttarpara, Hooghly	X-Ray
413	Vivekananda X-Ray Clinic	79, Desh Bandhu Road, Hindmotor, Hooghly	X-Ray
414	X-Ray & Diagnostic Clinic	Madanmohantala, Dhaniakhali, Hooghly	X-Ray
415	X-Ray & Surgical Clinic,	Basudevpur, P.O. Arambagh.	X-Ray
416	X-Ray Clinic	New Hospital Road, Chinsura, Hooghly	X-Ray
Numbers of Path Lab: 329 ; Blood Bank: 0 ; Dental Clinic: 6 ; Forensic Lab: 0 ; Eye Clinic: 1 ; Collection Centre: 1			
HOWRAH			
1	Abhishak X-Ray & Pathological Clinic	14/1 & 14/7, Meckenjee Lane, Howrah	Path
2	Aloka Pathological Laboratory	Jujersa (Mini Bus Stand), Panchala, Howrah	path
3	Alpha Medical Service (P) Ltd.	21/1, Moulana Abul Kalam Azad Road, Howrah	Path
4	Amta Polyclinic	Bagnan Station Road.	Path
5	Amta Thana People's Clinic	Jhikira	Eye
6	Amta X Ray Clinic	Amta Saha Para	X - Ray
7	Andul Path Center	Andul bazar, Hoarah - 711 302	path
8	Angel Pathological Lab.	Panchala, Howrah	path
9	Anubikshan Diag. Center	P - 25, Benaras Road, Howrah	path
10	Anubikshan Pathological Laboratory	Ekkari Singha Roy Road, Phuleswar, Vill & P.O.: Kushberia,	Path
11	Aparna Diagnostic & Res. Center	Jagacha, G.I.P. Colony, Howrah	path
12	Apex Club Of Bally	1, Dr. Bimla Charan Laha lane, Bally, Howrah	path
13	Apollo DiagnosticCenter	Vivek Vihar Block - G, 493/C/A G. T. Rd., Howrah	path

LIST OF DIAGNOSTIC CENTRES BY DISTRICT

Sl. No	Name of the Units.	Address	Services Catered
14	Arnavik Diagnostic & Pathology Center	52, Khetra Mitra Lane, P.O.: Salkia, Howrah - 711 106	Path
15	Asha Medical Center	121 / 95-98, J. N. Mukherjee Road, Ghusury, Howrah	Path
16	B. S. Diag Center	Dharsha Govt. Colony, Howrah - 12	path
17	Bagnan Clinical Laboratory	Bagnan Statipn Road (N), P.O.: Bagnan, Howrah	Path
18	Bagnan Pathological Laboratory	G. T. Road, P.O.: Bagnan, Howrah	Path
19	Bally Jana Serayatan	123, G. T. Road, Bally	path
20	Bally Kedarnath Arogya Bhawa	403, G. T. Road, Bally, Howrah	Path
21	Bansal Medical Service	268/2/B2, G. T. Road, Liluah, Howrah	path
22	Bargachia Clinical Lab.	Vill & P.O.: Bargachia, Howrah	Path
23	Bargachia Medical Center	Bargachia	Path
24	Bauria Pathological lab.	Bauria	path
25	Bikshan (Clinic & Day Care Center)	28/5, Nabanari Tala Lane (Old), Buxarah, Howrah	Path
26	Bikshan Lab	391 (4BII), G. T. Road, Bally, Howrah	path
27	Biswayan Diagnostic Center	94, Deshpran Sasmal Road, Howrah - 711 101.	Path
28	Blue Heaven Diagnostic & Polyclinic Center	Vill.: Panchla Bazar, P.O. & P.S.: Panchla, Howrah - 711322	Path
29	Blueview Clinic (P) Ltd.	4/2, Padmapukur Lane, Bally, Howrah	Path, X-Ray
30	Care & Cure Medical Center	12 / 21, Dharmatala Road Belurmath	Path, X-Ray
31	Central Medical Polyclinic	8, G.T. Road (S)	Path
32	Central Society of Optomaty	51, Kali Kumar Mukherjee Lane	Eye
33	Central X - Ray Clinic	24/1, G.T. Road (S)	X - Ray
34	Central X-Ray & Laboratory	Vill. & P.O.: Khadinan, Bagnan, Howrah	Path
35	Chikitsha Diag Center	Dhulaguri, Shibtala, Howrah	path
36	Chowdhury Pathological Laboratory	Gamago Chak, Howrah	path
37	Citicare Diagnostic Center	214, G. T. Road, Shibpur, Howrah - 102	Path
38	Clinico Path Lab	28, Arobindo Rd, Salkia	Path
39	Dakshin Sankrail Diagnostic Center	Vill. & P.O.: South Sankrail, Howrah - 711 313	Path
40	Dasnagar Medical Center	Howrah, Amta Road, Dasnagar, How - 05	path
41	Debojoyti X - Ray Clinic	266/4, G. T. Rd. Lilua	X - Ray
42	Deshopriya Polyclinic & X - Ray Clinic	Meghora, Howrah	Path, X-Ray
43	Dewanti Diagnostic Center	281/27/A/2, G. T. Road, Liluah, Howrah	Path
44	Dey Diag, Lab.	110, N. S. Road	Path
45	Dhara Poly clinic	Amta, Howrah	Path
46	Diagnosis Path Clinic	24, Belilius Rd. Howrah - 01	Path
47	Diagnostic	Andul Dakshonpara Andul Mouri	Path
48	Diganta Path Lab & Bio Chemicwal Res Lab.	Amta Saha Para	Path
49	Dinonath Sishu Sadan	21, Joydeb Kundu Lane	Path
50	Disha Pathological Lab	Deulpur, Panchala	Path
51	Dishari Clinical Laboratory	Sardarpara, Sankrail Station Road, P.S.: Sankrail, Howrah	Path
52	Doctors lab	5, Monilal Chaterjee Lane	Path
53	Doctors Laboratory	Jagatballavpur, Howrah	Path
54	Domjur Clinical & Research Laboratory	Domjur, Howrah	Path
55	Domjur Diag, Clinic	Jhapardah, Domjur	Path, X-Ray
56	Dr. Hari Har Roy Clinic	16/1, Kshetra Mitra Lane, Salkia, Howrah	Path
57	Dr. Mrs. Keka Dutta	272/2, Sarat Chatterjee Rd. How - 02	path

LIST OF DIAGNOSTIC CENTRES BY DISTRICT

Sl. No	Name of the Units.	Address	Services Catered
58	Dr. N. L. Ghosh Polyclinic	50, Khetra Mitra Lane, Salkia	Path
59	Dr. Sengupta's Pathological Laboratory	100, M. C. Lane, Howrah - 1	Path
60	Euro Medical Service	Stadium, 5B, Mahatma Gandhi Rd., How - 01	path
61	Eye Lab,	Gitanjali Aparentment, Ram Charan Seth Rd.	Eye
62	Friends Clinic & Laboratory	Uluberia	Path
63	Future Clinical Laboratory	Khurgachi, 58 Gate, Shyampur, Howrah	Path
64	Genesis Pathological Laboratory	23/7, P.K. Roy Chowdhury, 2nd Bye Lane, Howrah -103.	Path
65	Gitanjali Pathological Laboratory	Nabghora	Path
66	Green View Day Care & Eye Micro Surgery Center	Jangalpara, U. N. Pur	Eye
67	Health Care laboratory & Research Center.	Station Road, Bazarpara, Uluberia, Howrah	path
68	Howrah Diag. Clinic & Res. Cent.	2/6, Laxmi Narayan Chakraborty lane	Path
69	Howrah Medical Center	25, Guitendal lane, How - 1	Path
70	Howrah Pathological	515, G. T. Road (S)	Path
71	Ideal X-Ray & U.S.G. Clinic	Vill. & P.O.: Amta, Howrah	X - Ray
72	Indus Diagnostic Center	Padma, Andul Road, Howrah	Path
73	J. B. Clinical Laboratory	Bagnan Station Rd.	Path
74	Jagdhan Health care P. Ltd.	168, G. T. Road (S), Howrah - 102	path
75	Jana Pathological & Diag. Center	Khalisani, Kalitala, Howrah	path
76	Jibanjoyti Polyclinic	varona Bhwan, Amta	Path
77	Kalpana Clinic cum Lab.	14/3, Ramcharan Seth Rd.	Path
78	kalyani Clinical Lab	872 Sarat Chaterjee Rd.	Path
79	Kolkata medical Center (Andul Unit)	Andul Bazar, (Opposite UBl.)	Path, X-Ray
80	Kumar Danga Diag. Center	Ichapur, Sibatala	Path
81	Lakhotia medical Center	10, Dr. Abani Dutta Road, How - 01	path
82	Lakhotia medical Center	149, Beneras Road Salkia Howrah - 01	path
83	Lesco Enterprise (P) Ltd.	9, Kali Charan Singha Lane	Path
84	Life Care Complex	Baltikuri	path
85	Life Diagnostics	Nabghora, P. S.: Sankrail, Howrah - 711 322	Path
86	Life Guard Pathology	32, Swami Vivekanda Road, How - 2	Path
87	Life Line Diag. Center	Goalpara, J. B. pur	Path
88	Life Path Laboratory	Jujersah, Bhangore, Panchala	Path
89	Lilua Lions Medi aid Center	7, Guha Park, Lilua	Path
90	Liluah Charitable Dispensary & Belur Jubilee Clinical	230, G. T. Road, Belur, Howrah	Path
91	Lord Enterprise	545, G. T. Road (South), Howrah - 1	Path
92	Maa Sarada Eye Care	Amorjoyti Apartment, 1St Floor, Andul Rd. Danesh Sk. Lane,	path
93	Medi Aid Diagnostic Center	Shankrail, Howrah	path
94	Medi Land Diagnostic & Research Center	297/1, Bellious Road, Howrah	Path
95	Medi Star Diagnostic & Res. Cent.	3, N. D. Mukherjee Road, Howrah - 711 101	Path
96	Medicare Clinic & Research Center P. Ltd.	138, G. T. Road (S), Oppsite Howrah Jute Mill, How - 02	path
97	Medicare X - Ray & Pathology	Bagnan Station Road, P.O. & P.S.: Bagnan, Howrah	Path, X-Ray
98	Medicurve Diagnostic & Res. Center	P.O.: Makardah, Howrah	Path
99	Medisafe Diagnostic Center	297/1, Belius Road.	path
100	Meena Harmon Laboratory	162/163/1 Sastri N.N. Ganguly Road, Howrah	path
101	Met life medico	53, Sastri N.N. Mukherjee Lane	path

LIST OF DIAGNOSTIC CENTRES BY DISTRICT

Sl. No	Name of the Units.	Address	Services Catered
102	Micro Surgical Eye Clinic	1/4/2,Watkans Lane, How - 01	path
103	Middaya Diagnostic Center	Manshir Hat	path
104	Modern X-Ray Clinic	255 Panchanan Tala Road	X - Ray
105	Mohua Diagnostic Center	Buxarah, L.M.C. Sarani, Howrah - 110	Path
106	Mondal X - Ray & Pathology	Bazarpara, P.O. & P.S.: Uluberia, Howrah	X - Ray
107	Mordern Diagnostic Center & Clinic	96, Shibpur Road, Howrah - 711 102.	Path
108	Mordern Diagnostic Lab	103/1/2, KalaiKundu lane	path
109	Mordern X - Ray Clinic	Bazarpara, Uluberia	X - Ray
110	N. P. Medical Center	248/2, G. T. Road, P.O.: Liluah, Howrah	X - Ray
111	Nabajiban Clinical Lab.	3, N. D. Mukherjee Lane	Path, X-Ray
112	National Diagnostic Center	Bazarpara, Uluberia, Howrah	Path
113	National X - Ray Lab.	Banipur	X - Ray
114	New Life pathological laboratory	Amta Super market, Amta	path
115	New U. N. Pur X - Ray Clinic	U, N. Pur	X - Ray
116	Nibadita Physiotherapy Center	218/5, Mahendra Bhattacharjee Rd.	Physiotherapy
117	Nibedita Diagnostic Lab.	20, N. S. Bose Rd. Lilua	path
118	Nimble Diagnostic Center	34, Laxmi Narayan Chakraborty lane	Path
119	Niramoy Clinical lab.	Bazarpara, Uluberia, Howrah	Path
120	Niriksha Diagnostic Center	Belpukur, P.O.: Ajoydhya, Shyampur, Howrah	Path
121	Nirikshin Path Clinic	40, Dabshow Road	path
122	Nirnoy Pathology	Gabberia Hazi Market	Path
123	Nischinda X-Ray & Diagnostic Clinic	Sapuria, Bally, Howrah	Path, X-Ray
124	North Bank Diagnostic Center	320, G. T. Road.(N), Salkia Howrah - 06	path
125	Olin Diagnostic & Research Center	Bazarpara, Uluberia, Howrah	Path
126	Orchid Laboratory	229/7, N. S. Road, Howrah	Path
127	Pan Diagnostic Clinic & Lab	259 Panchanan Tala Road	X - Ray
128	Param Diagnostic	Bazarpara, P.O. & P.S.: Uluberia, Howrah	Path
129	Pariksha Clinical lab.	Bazarpara, Uluberia, Howrah	path
130	Pariksha Diagnostic Center(P). Ltd.	493/C/A, G. T. Rd., Shibpur, Howrah	path
131	Paul Eye Care	4/2/1, Chowdhuri Para Lane, How - 04	Eye
132	Popular Clinical Lab	Andul Rd. Shibpur, Bakultala	path
133	Probhati Laboratory	Zakaria Apertment,Thanamakua, Bakultala	path
134	R.N.R Diagonostic	453, Sarat chattarjee Road	Path
135	Raipro Diagnostic Center	Abhoynagar	X - Ray
136	Ramraja Tala X-Ray	Station Road (north)	X - Ray
137	Ruby Baby Clinic	108, Rabindra Sarani, Liluah, Howrah	Path
138	S. B. Pathological Laboratory	9/4, N - Type Quarter, Baltikuri, Bankra Bazar, P.S. Domjur,	Path
139	Sadin Eye Care & Micro Surgery Research Center	2, Bibi Bagan Lane, Salkia, Howrah	Path
140	Sai Care Diagnostic	432, G. T. Road (S), How - 02	path
141	Satya Sundari Path Lab	Khusberia, Uluberia	Path
142	Seba pathological laboratory	Belpukur, P.O.: Ajoydhya, Shyampur, Howrah	path
143	Sebalaya Cklinik & Res. Center	North Mill, B-Block, P.O.: Radhanagar, Bauria, Howrah	path
144	Sebayan Diagnostic Service (P) Ltd.	Garmirajipur (Andul Road), P.O.: Mashila, Howrah	Path
145	Seva Diagnostic Centr	Baltikuri, Bakultala, Howrah - 711402	Path

LIST OF DIAGNOSTIC CENTRES BY DISTRICT

Sl. No	Name of the Units.	Address	Services Catered
146	Shyamali Clinical Lab	Dhujursha,	Path
147	Shyampur X-Ray & Pathological Clinic	Vill.: Narikelbar, P.O.: Shyampur, Howrah	Path, X-Ray
148	Soham Clinic	Santragachi Station Road, Jagacha, Howrah	Path
149	Sonatala Milan Sangha Village Health Center	Bhawanipur, P.O.: Chitrasenpur, P.S.: Udaynarayanpur, Howrah	Path
150	South End Diag. Res. Center	71, Andul Road, Bakultala, Howrah	Path
151	South Point Diag. Res. Center	458, G. T. Road, Shibpur, Tramdepot, Howrah	Path
152	Span Diagnostic Center	Balpukur, P.O.: Ajothya, Shyampukur, Howrah	path
153	Standard Path Laboratory	Andul Bus Stand	Path
154	Suraksha Diagnostic & Research	Andul Chopwdhury Para, Andul-Mouri, Howra - 711 302	path
155	Swadin Eye Care	2, Hrishikesh Ghosh Lane, Salkia, Howrah-06	Path
156	Taj Diagnostics	Habib Markat, Bankra	X - Ray
157	Tara Clinic & Res. Center	Amta, Howrah	Path
158	The Bacto Laboratory	Bazarpara, Uluberia, Howrah	Path
159	The Bantra Co - Operative Bank Ltd.	15/1/1A, Bantra Public Sarani	Path
160	The Care & Cure Diagnostic Center	Bazarpara, Uluberia, Howrah	Path
161	The Howrah National Clinical lab.	225, Panchanantala Road.	Path
162	The Kalpana Clinic & Laboratory	14/3, Ram Charan Seth Road, How - 04	path
163	The Life Medical Center	391/B, G. T. Road (S), P.O.: B. Garden, Shibpur, Howrah	path
164	The Research Laboratory	10, Bharpara Road	path
165	Uluberia Pathological Clinic	P.O.: Jadurberia, Uluberia	path
166	Uluberia Station Rd. X - Ray Clinic	Bazarpara, Uluberia	Path, X-Ray
167	Uluberia X - Ray Clinic	Bazarpara, Uluberia	X - Ray
168	United X - Ray Clinic	Andul Bus Stand	X - Ray
Numbers of Path Lab: 146 ; Blood Bank: 0 ; Dental Clinic: 0 ; Forensic Lab: 0 ; Eye Clinic: 0 ;			
JALPAIGURI			
1	A. P. Laboratory	Hospital Road, Kamakshaguri, Jalpaiguri	Path
2	Anandalok Medical & Res. Center (P) Ltd.	2nd Mile, Sevok Road, Siiliguri	Path
3	Astha (A Diagnostic Clinic)	Kalibari Road, P.O.: Birpara, Jalpaiguri	Path
4	Bactro Clinical Lab	Mahakalnagar, Aslipurduar, Jalpaiguri	Path
5	Bengal Medical Laboratory	Kumargramduar, Jalpaiguri	Path
6	Bengal Pathological Laboratory	Hospital Road, Kamakshaguri, P.S.: Kamakshaguri, Jalpaiguri	Path
7	Bimala Diagnostic Center	Dhupguri, Jalpaiguri	Path
8	Bimala Imaging Center	Bairatiguri, Dhupguri, Jalpaiguri	X-Ray
9	Bimala Imaging Center	Kadamtala, Jalpaiguri	Path
10	Biotick Clinical Laboratory	Hospital Road, Alipurduar, Jalpaiguri	Path
11	Biswajit X-Ray Clinic	Hospital Road, Alipurduar, Jalpaiguri	X-Ray
12	Care Pathological Laboratory	New Town, Alipurduar, Jalpaiguri	Path
13	City Clinical Laboratory	Surjannagar, P.O.: Alipurduar Court, Jalpaiguri	Path
14	Deb Clinical laboratory	Hospital Raod, Alipurduar, Jalpaiguri	Path
15	Dey's Clinic	Hospital Raod, Alipurduar, Jalpaiguri	Path
16	Dey's Pathological Lab.	Mal Road, Maynaguri, Jalpaiguri	Path
17	Diag Clinical Lab.	Rly Bazar, P.O.: Alipurduar Junction, Jalpaiguri	Path
18	Diagnostic Laboratory	Mainaguri, Jalpaiguri	Path
19	Diagnostic Pathological Laboratory	Hakimpara Hospital Road	Path

LIST OF DIAGNOSTIC CENTRES BY DISTRICT

Sl. No	Name of the Units.	Address	Services Catered
20	Diagnostic Pathological Laboratory	Lanka Road, Birpara, Jalpaiguri	Path
21	Dolphin Pathological Laboratory	Ukilpara More, Jalpaiguri	Path
22	Dooars Clinical Lab	Hospital Road, Alipurduar, Jalpaiguri	Path
23	Dooars Pathological Laboratory	P.O.: Kumargramduar, Jalpaiguri	Path
24	Dooars X-Ray	P.O. & P.S.: Birpara, Jalpaiguri	Path
25	Dr. P. C. Ghosh's Lab	Goswami Bhawan, Natunpara, Jalpaiguri	Path
26	Dr. Ranjit Sarkar's Lab	Kadamtala, Jalpaiguri	Path
27	Dutta USG Unit	Bairatiguri, Dhupguri, Jalpaiguri	U.S.G
28	Dutta X Ray Clinic & Pathological Lab.	Bairatiguri, Dhupguri, Jalpaiguri	Path, X-Ray
29	Eveland Clinic (P) Ltd.	Hospital Road, Jalpaiguri	Path
30	Falakata Pathological Laboratory	Madari Road Bus Stand, P.O.: Falakata, Jalpaiguri	Path
31	Falakata X-Ray Clinic	Babupara, Falakata, Jalpaiguri	X-Ray
32	G. D. X-Ray & Diagnostic Center	Hospital Road, Kamakshyaguri, Jalpaiguri	Path
33	G. S. Laboratory	P.O.: Barobisha, P.S.: Kumargram, Jalpaiguri	Path
34	Ghosh Pathological Laboratory	Lanka Road, Birpara, Jalpaiguri	Path
35	Himalayan Pathological Laboratory	Samuktala, Durgabari, P.O.: Soantalpur, Jalpaiguri	Path
36	Jai Clinical Pathology	Kumargram Road, Jalpaiguri	Path
37	Jaigoan Pathological Lab	Jaigoan, Jalpaiguri	Path
38	Jalpaiguri Eye Foundation	Raikatpara, Jalpaiguri	Path
39	Jeeban Suraksha Diagnostic Center	P.O.: Mal, Jalpaiguri	Path
40	Jeeban Suraksha Laboratory	Alipurduar, Jalpaiguri	Path
41	Jeebandeep Pathological Laboratory	Lanka Road, Birpara, Jalpaiguri	Path
42	Jeevan Deep Pathological Laboratory	Kamakshyaguri Hospital Road, Jalpaiguri	Path
43	Jeevan Suraksha USG Unit	Thana Road, Jalpaiguri	U.S.G
44	Jiban Suraksha Pathological Lab	Maynaguri, Jalpaiguri	Path
45	K.D. X-Ray	P.O. & P.S.: Birpara, Dist.: Jalpaiguri	X-Ray
46	Kosturi (C/o Green Land N. Home)	Hospital Road, Alipurduar, Jalpaiguri	Path
47	Kushmandi Pathological Laboratory	Kushmandi, Dakshin Dinajpur	Path
48	Life Line Clinical Laboratory	Binnaguri, Jalpaiguri	Path
49	Linos Club of Gairkata (C/o Lions seva Sadan)	P.O.: Gairkata, Jalpaiguri	Path
50	Lion Service Center	Dharmasala Road, Banarhat, Jalpaiguri	Path
51	Lions Eye Research Center	Alipurduar, Jalpaiguri	Path
52	Lions Service Center	Banarhat, Jalpaiguri	Path
53	Little Flower Pathological Lab.	Falakata, Jalpaiguri	Path
54	Maa Kamakshya Clinical Investigation Center	2nd Mile, Sevok Road, Jalpaiguri	Path
55	Mandal Pathological Laboratory	P.O.: Bhutanirghat, P.S.: Falakata, Jalpaiguri	Path
56	Medinova Diagnostic Center	Alipurduar Hospital Road, Jalpaiguri	Path
57	Mediscan	Hakimpara, Jalpaiguri	Path
58	Merina Medicare & Research Center (P) Ltd.	Babupara, Falakata, Jalpaiguri	Path
59	Merina Sonography	Alipurduar, Jalpaiguri	Path
60	Micro-Ray diagnostic Laboratory & X-Ray Center	Hospital Road, Kamakshaguri, P.S.: Kamakshaguri, Jalpaiguri	Path, X-Ray
61	Moon Laboratory	Hospital Road, Falakata, Jalpaiguri	Path
62	Moon Light Laboratory	P.O.: Jateswar, P.S. Falakata, Jalpaiguri	Path
63	Mordern Clinical Lab	Hospital Road, Alipurduar, Jalpaiguri	Path

LIST OF DIAGNOSTIC CENTRES BY DISTRICT

Sl. No	Name of the Units.	Address	Services Catered
64	Mordern Diagnostic & Research Center	Rajapara, P.O.: Malbazar, Jalpaiguri	Path
65	New A.T.S. Laboratory	Samuktala Bus Stand, P.O.: Soantalpur, Jalpaiguri	Path
66	New Birpara Diagnostic Center	P.O. & P.S.: Birpara, Jalpaiguri	Path
67	Nirikha Pathological Laboratory	Netaji Para, P.O. & Dist.: Jalpaiguri	Path
68	Nirmala Laboratory	Dinabazar, Jalpaiguri	Path
69	Nirmala Laboratory	Pin Bazar, Jalpaiguri	Path
70	Nirnayan Pathological Lab	Thana Road, Falakata, Jalpaiguri	Path
71	Nivedita Lab	Natunbazar, Hospital Road, Mainaguri, Jalpaiguri	Path
72	P.S. Laboraotry	Khidirpur, P.O.: Madhya Rangali Bazna, Jalpaiguri	Path
73	P.S. Pathological Laboratory	P.O.: Barobisha, Jalpaiguri	Path
74	Palash Diagnostic Center	Palas Lari, Shilbarihat, Jalpaiguri	Path
75	Panna Diagnostic Center	Banarhat Bazar, Jalpaiguri	Path
76	Pastur Clinical Laboratory	Banarhat, Jalpaiguri	Path
77	Pastur Lab	Debinagar, Mainaguri, Jalpaiguri	Path
78	Pathological Laboratory	Kadamtala, Jalpaiguri	Path
79	Pragati Laboratory	Kartick Chowpathi, Jalpaiguri	Path
80	Prasanthi Ultra Scan	2nd Mile, Sevok Road, Jalpaiguri	Path
81	Prime Lab.	Lanka Road, Birpara, Jalpaiguri	Path
82	Priya Clinical Laboratory	2nd Gate, Hopital Road, Alipurduar, Jalpaiguri	Path
83	R. C. Pathological Laboratory	Hospital Road, Kamakshaguri, P.S.: Kamakshaguri, Jalpaiguri	Path
84	R. D. Diagnostica	Tinbatti More, Siliguri Bazar, Jalpaiguri	Path
85	R.D. Clinic	Birpara, Jalpaiguri	Path
86	R.D. Diagnostica	Tinbatti More, Siliguri Bazar, Jalpaiguri	Path
87	Ramkrishna Mission Charitable Dispensary	Mission Road, Ashrampara, Jalpaiguri	Path
88	RD Diagnostic Lab	Deshbandhupara, Siliguri, Jalpaiguri	Path
89	RNR X-Ray Clinic	Thana Road, Jalpaiguri	X-Ray
90	Roy Chowdhury Laboratory	Hospital Road, Kamakshaguri, Jalpaiguri	Path
91	S.S. Laboratory	P.O.: Bhatibari, Hospital Road, Jalpaiguri	Path
92	Samrat Pathological Lab	Hospital Road, Alipurduar, Jalpaiguri	Path
93	Sarkar Clinical Lab.	Bhatibari, Jalpaiguri	Path
94	Seba Laboratory	Hospital Road, Alipurduar, Jalpaiguri	Path
95	Sebayan Lab.	Lanka Road, Birpara, Jalpaiguri	Path
96	Sebayan Pathological Lab.	Jalpaiguri	Path
97	Sen's Pathological Laboratory	P.O. & P.S.: Banarhat, Jalpaiguri	Path
98	Sickle Pathological Laboratory	Banarhat, Jalpaiguri	Path
99	Siliguri Terai Lions Charitable Trust	2nd Mile, Sevok Road, Siliguri, Jalpaiguri	Blood Bank
100	SS Laboratory	Hospital Road, Bhatibari Alipurduar, Jalpaiguri	Path
101	Subha Clinical Lab	Hospital Road, Alipurduar, Jalpaiguri	Path
102	Subhashini Diagnostic Systems	Hospital Road, Birpara, Jalpaiguri	Path
103	Suhasini Diagnostic System	Hospital Road, P.O.: Birpara, Jalpaiguri	Path

LIST OF DIAGNOSTIC CENTRES BY DISTRICT

Sl. No	Name of the Units.	Address	Services Catered
104	Sunshine Diagnostic System	Hospital Road, Birpara, Jalpaiguri	X-Ray
105	Suraksha Clinical Lab	Hospital Road, Alipurduar, Jalpaiguri	Path
106	Suraksha Laboratory	Hospital Road, Kamakshaguri, P.S.: Kumargram, Jalpaiguri	Path
107	Suravi Diagnostic Center	Ghoshpara More, P.O.: Bairatiguri, P.S.: Dhupguri, Jalpaiguri	Path
108	T. K. Laboratory	Hospital Road, Kamakshaguri, P.S.: Kamakshaguri, Jalpaiguri	Path
109	T.R. Diagnostic Laboratory	Madhab More, New Town, P.O.: Alipurduar, Jalpaiguri	Path
110	The Devine Pathological Laboratory	P.O.: Mal, Jalpaiguri	Path
111	Tr Diagnostic Lab	Alipurduar, Jalpaiguri	Path
112	Uma X-Ray Clinic	Maynaguri, Jalpaiguri	Path
113	Verma Clinical Laboratory	P.O.: Kalchini, P.S.: Kalchini, Jalpaiguri	Path
Numbers of Path Lab: 104 ; Blood Bank: 1 ; Dental Clinic: 0 ; Forensic Lab: 0 ; Eye Clinic: 0 ;			
KOLKATA			
1	A.R.S. Specialty Clinic	79, Vivekananda Rd, Girish Park, Kol - 06,	Path
2	ABN Diagnostic Centre & Polyclinic	36D, Pramesh Mitra Road, Kolkata – 700 025	Path
3	Advance Medicare	118C, A.P.C. Road, Kol - 14	Path
4	Airway Care Clinic	P-103 C.I.T. Road (Gr H), Kolkata – 700 014	Path, X-Ray
5	Alipore Diagnostic & Research Centre	11/C, Chetla Central Road, Kolkata – 27	Path, ECG, X-Ray
6	Allergy & Asthma Treat. Centre	155A, AJC Bose Road; Kolkata – 700 014	Path
7	Aloka Medicare (P) Ltd.	114B, Sarat Bose Road, Kolkata – 700 029	Path
8	Amit Diagnostic	1/D, Sarada Maa Upanibesh, Kol - 60	Path
9	Amplicon JSN Advance Diagnostic & Research Center	6, Russel Street, Russel Mansion, 1st Floor, Kol - 71	Path
10	AMRI (Day Care)	97A, Southern Avenue, Kol - 29	Path
11	AMRI (Out Door)	97A, Southern Avenue, Kol - 29	Path
12	AMRI (Path)	97A, Southern Avenue, Kol - 29	Path
13	Analab	89, Satyen Roy Road, Cal-32 (Behala)	Path
14	Analytique Medicare	54/1B, Bakul Bagan Road, Kolkata – 700 025	Path
15	Analytic Medicare	6, Mullick Lane, Kolkata - 700 025	Path
16	Ananda Clinic	567/1, D. H. Road, Behala, Kolkata - 34	Path
17	Ani Polyclinic	111B, M. G. Road, Bidhan Pally, Kolkata - 700063.	Path
18	Anita Pathological Lab	46/F/7, 1st Floor, N. C. Mitra Road, Kol - 28	Path
19	Anwasha	86 Brajamoni Debya Road, Kolkata - 700061	Path
20	Apex Diagnostic Laboratory	92B, Fazlul Haque Sarani, Kolkata – 700 017	Path
21	Apollo Clinical Laboratory	116 / 1 / 1, M G Road, Kolkata – 700 007	Path
22	Apollo Gleneagles Clinic (Path)	48/1F Leela Roy Sarani Kol - 19	Path
23	Apollo Gleneagles Hosp Ltd. (Path)	58, Canal Circular Rd. Kol - 32	Path
24	Appex Diag Service(Unit of Dream Land Nursing	3B, Shyam Square (East), Kol - 03	Path
25	Aqua Pathline	7, Dr. Sudhir Bose Road, Kolkata – 700 023:	Path
26	Arati Electro Diagnostic Lab	28 A, Madan Mitra Lane, Kolkata – 700 006	E.E.G, X-Ray
27	Archive Pathology & Radiology Center	18/3, Dr. G. S. Bose Road, (Lalkuthi), Kolkata – 700 039	Path, X-Ray, USG
28	Archive Pathology & Radiology Centre	39 / 3B, R K Chatterjee Road, Kolkata – 700 042	Collection Center

LIST OF DIAGNOSTIC CENTRES BY DISTRICT

Sl. No	Name of the Units.	Address	Services Catered
29	Areva T & D (I) Ltd.	1, Taratala Road, Kolkata - 24	Path
30	Arham Clinics	70, C.R.Avenue, Kolkata –700012.	Path,ECG,X-Ray
31	Arogya Sanchar Clinical Laboratory	67B, New Santoshpur Main Road, Klo - 75	Path
32	Ashok Laboratory	1/368, Gariahat Road (S), Kolkata - 68	Path, X-Ray
33	Ashok Laboratory	308B, Jodhpur Park, Kolkata – 700 068	Blood Bank
34	Astha Medical Center	174/4C, N.S.C. Bose Road, Kol - 40	Path
35	Avenue Clinical Laboratory	69, Chowranghee Road, Kol - 20	Path
36	Avenue Xray Clinic	8B Jatindra Mohan Avenue: Kolkata – 700 006	X-Ray, U.S.G.
37	Avinash Diagnostics	310, Canal Street, Kolkata - 700048.	Path
38	Ayurbikshan	Haradhan Chakraborty Sarani, P.O. Sonarpur, Kolkata - 150	Path
39	B B Eye Foundation	512, Sarat Bose Rd. Kol - 26	Path
40	B B K Diagnostic Laboratory	42/1A, Harish Mukherjee Rd. Kol - 25	Path
41	B. K. Dutta Memorial Medical Cent.	4K Ballygunge Station Rd. Kol - 19	Path
42	B. M. Immunoresearch	7, Mohanbagan Lane, Kolkata – 700 004	Path
43	B.B.S. Mediscanners	1700, Rajdanga Main Road, Kasba, Kolkata - 107	Path
44	B.C.D.Medicare	743,D.H.Road, Kolkata – 700 008	Path
45	Bacto Clinical Laboratories	95, Vivekanda Road, Kol - 06	Path
46	Bacto Clinical Inst. & Lab.	4, Beliaghata Main Road, Kolkata – 700 085	Path
47	Baghbazar Chest Clinic (CMC)	78, Baghbazar Street, Kolkata – 700 003	Path
48	Baithakkhana Dispensary (C.M.C.)	92, Baithakkhana Road, Kolkata – 700 009	Path
49	Bakson's Homeopathic	31, Shakespeare Sarani, Kol - 17	Path
50	Balaji Diagnostic Center	188/35A, Lake Gardens, Gobindapur Road, Kol - 45	Path
51	Banerjee Laboratory	4, Mohan Chand Road, Kolkata – 700 023	Path
52	Bangur Medicare Research Institute	8A, D.H.Road, Kolkata –700063	Path
53	Bansal Diagnostics	P-27,Manicktala Main Road,C.I.T. Scheme - VIIM, Kol-54	Path
54	Bansal Diagnostics	3B, K.K.Tagore Street, Kolkata – 700 007	U.S.G, E.C.G
55	Behala Diagnostic Centre	73/1, D.H. Road, (Hindustan Park) Kolkata – 700 034	Path,ECG,X-Ray
56	Behala Xray Clinic	47B, Block-C, New Alipore, Kolkata –700 053	X-Ray, U.S.G.
57	Bengal Rural Welfare Society Pol. & Lab.(N. Home)	279, Kendua Main Road Kolkata - 700084.	Path
58	Bengal Tuberculosis Association	24, Dr. Sundarimohan Avenue, Kol - 14	Path
59	Beta Clinical Laboratory Pvt. Ltd.	98/5B, S N Bannerjee Road : Kolkta – 700 014	Path
60	Bhattacharjee Diagnostic & Doctor's Clinic	22A , Amrita Bannerjee Road, Kolkata – 700 026	Path
61	Bhoruka Res. Cent. For Hematology & Blood	63,R.A.Kidwai Road, Kolkata- 700 016	Blood Bank
62	Bikomed Diagnostics	155A, Sarat Ghosh Garden Road, Kol - 31	Path
63	BIKSHAN CLINIC & DIAG.CENTRE	18 Ibrahim Road : Kol:23	Path
64	Binayak Imaging & Diagnostic Pvt. Ltd.	59, Kali Charan Ghosh Road, Kol - 50	Path
65	Bio Clinic Research Centre	45/1, Rafi Ahmed Kidwai Road, Kolkata – 700 016	Path
66	Bio Equivalence Study Centre (J.U.)	26A/2, Central Road , Kol - 32	Path
67	Bio -Med Diagnostic.	155 - A, Sarat Ghosh Garden Rd.	Path
68	Bio Speciality Assay Lab.	13, Lala Lajpat Roy Sarani, Kol - 20	Path
69	Bioclinic Pathological Laboratory	567 D H Road, Kolkat – 700 034	Path
70	Bio-Seetal	20, Camac Street, Kolkata - 700 016	Path
71	Biotech Diagnostic & Imaging Centre	71A, Charu Chandra Avenue, Kolkata - 700 033	Path
72	Biswa Xray & Ultrasonography	40A, S. R. Das Road, Kolkata – 700 026	X-Ray, U.S.G.

LIST OF DIAGNOSTIC CENTRES BY DISTRICT

Sl. No	Name of the Units.	Address	Services Catered
73	Blue Print Lab	162A, A.J.C. Bose Road, Usha Kamal, Kol - 14	Path
74	Body Care Pathological Service (P) Ltd.	218, C. R. Avenue, 1st Floor, Kol - 6	Path
75	Bodycare Diagnostic Centre Pvt.Ltd.	276, Rabindra Sarani: Kolkata – 700 007,	X-Ray, U.S.G.
76	C. D. L. B. Out Patient Department	Nimak Mahal Road, P. S.: West Port, Kolkata - 700 043	Out Door
77	C.D.P Medicare (P) Ltd.	P-599,Keyatala Road, Kolkata – 700 029	U.S.G
78	C.I.T. X-Ray Clinic	139/1,Ananda Palit Rd,Blk-IV, Kolkata – 700 014	X-Ray
79	C.S.P.C.A. Dog & Cattle Hospital	276 B.B. Ganguly Street, Kol - 12	Path
80	Cal. Recerch Cent. Lab. (C. R. C.)	15/2C, Balaram Ghosh Street. Kolkata – 700 004	Path
81	Calcutta Bacterological Institute (P) Ltd	105 Vivekanada Road : Kolkata – 700 006 ,	Path
82	Calcutta Clinical Lab	36, Ritchie Road, Kolkata – 700 019	Path
83	Calcutta Clinical Laboratory	151, D H Road, Kolkata – 700 034	Path
84	Calcutta Diagnostic	79, Sambhunath Pandit Street, kol - 20	Path
85	Calcutta Diagnostic Laboratory	2 Dhapa Road (1st Floor) Kolkata – 700 105	Path
86	Calcutta Diagnostic Point	4D Tiljala Road, Kolkata – 700 046	Path
87	Calcutta Heart Research Centre	114B, Sarat Bose Road, Kolkata – 700 029	Path
88	Calcutta Hemeophilia Society (Both are Separate Unit)	E. M. By Pass, Kol - 99	Path
89	Calcutta Hemeophilia Society (It is not a Double Entry)	E. M. By Pass, Kol - 99	Path
90	Calcutta Investigation Centre	7, Kabitirtha Sarani : Kolkata – 700 023	Path
91	Calcutta Medical Center	12, Dr. U. N. Brahmchari Street, Kol - 17	Path
92	Calcutta Medical Imaging Institute Ltd.	54, Jawaharlal Nehru Rd, Kol-71	Diagnostic Centre
93	Calcutta Motor Dealers Association	8 Bow Street, Kolkata – 700 012	Doctor's Chamber
94	Calcutta Pathological Lab	31/B Pulin Khatik Rd, Kol-15	Path
95	Calcutta Pathology Inst.Diag & Res.Cent.	P-20 CIT Scheme: VIIM : Kol- 67	Path
96	Calcutta Serological Institute and Lab.	9/3, Jaharlal Nehru Road, Kolkata – 700 013	Path
97	Calcutta Skin Institute	169 CIT Scheme - VI M, Kolkata -7000 54 :	Out Door
98	Cardio Vascular Imaging Cent.	54, Jawaharlal Nehru Road: Kolkata -700071 .	ECG, EEG
99	Care	11 Seal Lane : Kolkata -7000 15	Path,X-Ray,USG
100	Care & Cure Diagnostic Centre	37, Gorachand Rd : Kol-14	Path
101	Care & Cure Medical Centre	412 B/1, NSC Bose Road : Kolkata –7000 47	Path,X-Ray,USG
102	Care & Cure Radiology	37 Gorachand Rd : Kol-14	X-Ray, E.C.G
103	Care Fertility Solution (P) Ltd. IVF	28B, Kalighat Road, Kolkata - 25	Path
104	Cent.For Tropical Medi.& Parasitology	8A, Peari Mohan Roy Rd : Kol -27.	B.M.Res.&Training
105	Central Diagnostics	68B , APC Road : Kolkata -700009.	Path
106	Central Forensic Science Laboratory	30, Gorachand Road, Kol - 14	Forensic Lab
107	Central X-Ray Clinic	58/2, Central Road Kolkata -700032.	Path,X-ry, USG,ECG
108	Centre For Digestive Diseases	54, J Nehru Road : Kolkata – 700 071	E.R.C.P
109	Chandrakona Cli. Lab.	26, Brindaban Paul Lane, Kolkata – 700 003	Path
110	Chandrakona Clinical Laboratory	12/1 Bagh Bazar Street: Kolkata -700 003.	Collection Center
111	Chikitsa Medicare Centre (P) Ltd.	6, D.H. Road Kol - 34	Path
112	Chowdhury Clinical Laboratory	173A/1C, Beliaghat Main Road: Kolkata –700010.	Path
113	Citizens Clinical Laboratory	45/5, Brawnfeld Row, Kolkata –700027.	Path
114	City Laboratories	120B/1B, A.J.C.Bose Road, Kol-14	Path

LIST OF DIAGNOSTIC CENTRES BY DISTRICT

Sl. No	Name of the Units.	Address	Services Catered
115	City Dental Hospital	241,B.B.Gangully Street, Kolkata – 700 012	Dental Withchair
116	City Diagnostics	9, C R Avenue, Kolkata -7000 72.	Path,X-ry,USG,ECG
117	City Diagnostics	1-215, Paharpur Road , Kolkata -7000 24. (Metiaburuz Branch)	U.S.G
118	City Diagnostics:	20B, Karl Marx Sarani, Kolkata -7000 23. (Khidderpur Branch)	Path,X-ry,USG,ECG
119	City Laboratories	31 Free School Strret , Kolkata-7000 16.	Path
120	City Laboratories	1 / 1, Collin Lane, Kol - 16	Path
121	Clini Test Pathological Laboratory	76 A, Lake View Road : Kolkata – 700 029	Path
122	Clinic & Laboratory	19 Ekdalia Place : Kolkata – 700 019	Path
123	Clinical Hematology Service	4 Gorky Terrace Kolkata – 700 017	Path
124	Clinical Laboratoriespvt.Ltd	2A C R Avn, Kol – 700 072 ,	Path
125	Clinical Laboratory	53, Jatindra Mohan Avenue, Kolkata – 700 005	Path
126	Clinicare Diagnostic Centre	69B, Santoshpur Avn, Kol – 75 ,	Path,ECG,X-Ray
127	Clinic-M Medical Diagnostics (P) Ltd	5, Sir Debaprada Row, Kolkata -: 14 (Suri Lane),	Path
128	Cliniquet Diagnostic	7B, Deshpran Shasmal Road, Kol - 33	Path
129	Cliniquet Diagnostic Centre	170, D.H.Road,Cal-63	Collection Center
130	Clinitest Pathological Laboratory	76A, Lake View Road, Kolkata – 700 029	Path
131	Complete Care	40/2/1Z, Lake Road, (1st Floor), Kolkata – 700 029	Endoscopy
132	CRC Diagnostic	15/2C Balaram Ghosh Street, Kol - 04	Path
133	D. D. HEALTH HOME	P-5, CIT Scheme IV MS 2, B. M. Rd : Kol ; 10	Path
134	D. G. Medicals	7/1,Bijoygarh (Uday Shankar Sarani),Golf Green Center,Kol-32	Path
135	DAS RES.CENT. & CLINICAL LAB:	52/1 Satyen Roy Road : Kol: 34	Path
136	Delta Diagnostic & Health Care	87/B, Elliot Road, Kolkata - 16	Path
137	Dental & Oral Health Clinic	18, Southern Avenue, 1St Filor, Kolkata - 26	Path
138	Dental Clinic	1, Dr. Suresh Sarkar Road,Cal-14	Dental Withchair
139	Dental Clinic	122/B, Karl Marx Sarani,Cal-23	Dental Withchair
140	Dental Clinic	34, Vivekananda Road,Cal-07	Dental Withchair
141	Dental Clinic	2, Brajendralal Ganguly Lane,Cal-33	Dental Withchair
142	Dental World	60/1, Chowringhee Road, Flat No.: 11, Kol - 20	Dental Withchair
143	Deshari	99/5/8C Bally Guange Place Kol - 19	Path
144	Dewan Medicare	48, Amdanga Colony, B.T. Road, Sukhchar, Kolkata - 700 115	Clinic
145	Dey's Eye Center	Debidarshan Buildidng 2nd fl, 83 S. P. Mukherjee Road, Kol - 26	Path
146	Diagnosis & Cure Centre	39, Gariahat Road (S),Cal-31	Path
147	DIAGNOSTIC CLINIC & LAB.	176 B B Ganguly Street : Kol - 12	Path
148	DIAGNOSTIC MICROCLINIC	18 / 1, Nimtala Ghat Street: Kol : 6	Path
149	Diagnostic Pathological Laboratories	13/5/A, Ariff Rd,Cal-67	Path
150	DIAGNOSTICS	190B Rash Behari Avenue : Kol:29	Path
151	DIAGONOSTIC CLINICAL LAB.	206 A, SP Mukherjee rd: Kol: 26	Path
152	Dimension Medicare Center	8A, Harish Mukherjee Road, Kol - 20	Path
153	DIPAK MEMORIAL TRUST	26 / 1, Gariahat Road (S) Kol : 31	Path
154	Divine Diagnostic Center (P) Ltd.	15B, Abinash Chandra Banerjee Lane, Beliaghata, Kol - 10	Path
155	Divine PolyClinic Res.Cent.	2c,North Road, Kolkata 700 032	Path
156	DOYEN DIAG.& RES. FOUNDATION	59 Bhupen Bose Avenue : Kol : 4	Path
157	Dr. A.m. Mukherjee & Dr. A.K. Mukherjee Path Lab	22A, Nalin Sarkar Street,Cal-04	Path

LIST OF DIAGNOSTIC CENTRES BY DISTRICT

Sl. No	Name of the Units.	Address	Services Catered
158	Dr. B. C. Roy Poly Clinic, Dept. of H & FW, GoWB.	Wellington Square, Kol-13	Path,ECG,X-Ray
159	DR. BARAT's MEMORIAL CLINIC	2/3 B, Southern Avenue: Kol: 26	Doctor's Chamber
160	Dr. Batras Possitive Health Clinic (Doc. Chem)	227/1A, AJC Bose Road : Kol: 20	Homeopathy
161	Dr. Batras Possitive Health Clinic	17/1, D Alipore Road , Kolkata - 700 027	Poly Clinic
162	Dr. Bhabesh ch Lahiri Memo medi res cent	36B, Lala Lajpat rai Sarani: Kol: 20	Path
163	Dr. Bhola Nath Chakraborty Memorial Clinic &	30A, Jahar lal Nehru Road, Kolkata - 700 016.	Path
164	Dr. Bhutta's Dental Clinic	159/1, M.G. Road Kol - 07	Dental Withchair
165	Dr. Chowdhury's Dg. Lab.	550/2, D.H. Road, Kolkata - 34, Manton	Path
166	Dr. Dasgupta's Clinic (Laboratory)	78, Ballygunge Garden,Cal- 700 019	Path
167	Dr. De's Clinical Laboratory	162/64 (D 596), Lake Gardens, Kolkata - 700 045	Path
168	Dr. Ghosh Pathological Laboratory	Q562/A, S. A. Farooquie Road, P.O.: Metiaburuz, Kol - 24.	Path
169	Dr. Jayanta Kr. Chakraborty	19, Babubagan Lane,Cal-31	Path
170	Dr. K. C .Basu Mullick Memorial Cl.	P-185,CIT Rd.Schm-VI-M, Cal-54	Doctor's Chamber
171	Dr. K.K.Thakkar's Lab.	59, Bentick Street,Cal-69	Path
172	Dr. Lal's Path	44, Bhupen Bose Avenue, Kolkata - 04	Path
173	DR. M C PAUL'S BACTERIOLOGICAL LAB	131-C, Bidhan Sarani : Kol : 4	Path
174	Dr. M. C. Paul's Bacteriological Lab.	35,Robert Street, Kol-12	Collection Center
175	Dr. Manjira Bhattachrya DENTAL Chember	28/1, Gariahat Road (South): Kol:31	Path
176	DR. MANNA's XRAY & ULTRASOUND Clinic	143D, Lenin Sarani: Kol: 13	X-Ray, U.S.G.
177	DR. RANJAN KUMAR MITRA'S LAB.	35 A, Kailash Bose Road : Kol : 6 (College St. More)	Path
178	Dr. Roys Diagnostic Centre	136/1, B. K. Paul Avenue, Kol - 05	Path
179	Dr. Sarders Laboratory	23 College street : Kolkata -7000 73.	Path
180	Dr. Sudarshan Chak.Memo Cent.For Res.&Treat.	P-198 CIT Sch:VII M , Ultadanga Main Road : Kol: 67	Path,ECG,X-Ray
181	Dr. Tribedi & Banarjee Clinical Lab.	14/4,Gariahat Road, Cal – 19	Path
182	DR.DIPTENDU MUKHERJEE'S CLINIC	126 Harish Mukherjee Road : (Ground Floor) : Kol: 25	Path
183	Dr.Haresh Jasani	18/1A Balaram Bose Street Kol - 20	Path
184	DRS. TRIBEDI & ROY DIAGNOSTIC LAB	93 , Park street : Kol : 16	Path
185	DRS. TRIBEDI & ROY DIAGNOSTIC LAB	48A D H Road: Kol:- 27	Collection Center
186	E. M. BYPASS POLYCLINIC & DIAG. CENT.	4/1, VIP Nagar : Tiljala: Kol: 100	Path, E.C.G,
187	East India Health Care Pvt Ltd.	1470 , Rajdanga Main Road Kol - 107	Path
188	Eastern Clinical Complex	285/1, S. K. Deb Road, Kol - 48	Path
189	EASTERN DIAG & Mediacal CENTRE LTD	13C, Mirza Galib Street : Kol : 16	Path
190	Eastern Diagnostic & Medical Centre	6, Vivekananda, Kol - 07	Path
191	Eastern Diagnostic & Medical Centre Ltd.	41B, S.P. Mukherjee Road, Kolkata - 700 026	Path
192	Ecstasy Clinic	27/9C, Chandighosh Road,Cal-40	Doctor's Chamber
193	Eden Medical Complex	B-68, Survey Park, Kolkata - 75	Path
194	EEG CENTRE (Ushakamal)	162 / A, A J C Bose Road : Kol: 14	E.E.G
195	EKO DIAGNOSTICS (P) LTD	54 J L Nehru Road : Kol : 71	X-Ray, U.S.G.
196	EKOX-Ray & Imaging Institute	54, Jawaharlal Nehuru Road, Cal-71	X-Ray, U.S.G.
197	Endoscan Diagnostic Center & Doctors Chember	Unit - IIA, Sambhunath Pandit Street, Kol - 20	Path
198	ENDOSCOPY CLINIC	155 A J C Bose Road : Kol : 14	Endoscopy

LIST OF DIAGNOSTIC CENTRES BY DISTRICT

Sl. No	Name of the Units.	Address	Services Catered
199	Escanavision	115, Khudiram Bose Road, Kolkata - 04	Path
200	Everest India Ltd.	1, Taratala Road, Kolkata - 24	Path
201	Eye Microsurgery & Diagnostic Center	29A, Kali Kumar, Banerjee Lane, Kolkata - 2	Path
202	F. M. C. Health Center	207, N. S. C. Bose Road, Kol - 47	Path
203	FAIRCARE	82A, Dr Sudhir Bose Road Kol - 23	Path
204	Fare Care X-Ray & Clinical Lab.	82/A/H/5, Dr Sudhir Bose Road Kol - 22	X-Ray
205	Family Planning Centre	171, B.B.Ganguly Street, Cal-12	Path
206	FATEHPURIA MEDICAL FOUNDATION	87 / 1B, K G Basu Sarani: Kol: 85	E. C. G
207	Florance Diag. Centre	10/1, B.N.Rd. Cal-60	Path
208	FLORENCE DIAGNOSTIC CENTRE	274/1 D H Road : Kol: 34	Path, ECG, X-Ray
209	FLORENCE POLYCLINIC & DIAGNOSTIC	19 B T Road: Kol:2	Path
210	G K HEMKA MEMO. (O.D) EYE CLINIC	12 A, Nilmoni Mitra Street : Kol : 6	Doctor's Chamber
211	Galaxy Medicals Center	1, Baikuntha Saha Road, Santoshpur, Kolkata - 75	Path
212	Gama Spect	33, DR. Sundari Mohan Avenue, Kol - 14	Path
213	Garia Eye Clinic & Eye Microsurgery Center	173, Kanungo Park, Kolkata - 700 084	Path
214	GAUTAM LABORATORIES	9A, kali Krishna Tagore Street : Kol: 7	Path
215	GAUTAM LABORATORIES Imaging & Research	7, Kali Krishna Tagore Street : Kol: 7	Path
216	Gautam Laboratory	56A, Hariram Goyanka St., Cal-07	Path
217	GEMINI'S IMAGING CLINIC (P) LTD	Flat 2 D: Suparna : 131A R B Avenue : Kol: 29	Path
218	Genix Laboratory	11/1, Vivekananda Road, Bansdrani, Regent Park, Kol - 70	Path
219	Glory Diagnostic centre	33A, Durgapur Colony, Kol - 53,	Path
220	Goethals Memorial Health Center	3, Lenin Sarani, Kol - 13	Path
221	GONARD SPECIALIST CENTRE	C 36 Lakshinarayan Colony Kol - 47	Doctor's Chamber
222	GOPAL LABORATORY	38 B K Pal Avenue: Kol: 5	Path
223	Grand Chemist & Druggist (Medicine Shop)	97/1, Bidhan Sarani, Cal-06	Medicine Shop
224	HARIPRIYA PAUL JANA SEVA ANGAN	102 A, Sree Aurobinda Sarani : Kol: 6	X-Ray, E.C.G
225	HARLEM POINT :	56, Chowringhee Road : Kol : 7,	Path
226	HARMONY : UFWC	1, S N Roy Road : Kol: 38	Family Welfare
227	HARRINGTON XRAY CLINIC	6, Ho Chi Minh Sarani : Kol:71	X-Ray
228	Harvard Medicare Res.Inst	42, Circus Avenue, Kolkata - 17	Path
229	Healing Touch Poly Clinic	45, Shibaji Road, West Rajpur, kol - 32	Path
230	Health Diagnostic Center	Balia Main Road (Middle), Kolkata - 84	Path
231	Health Line Diagnostic Centre.	27/9, Chandi Ghosh Road, Cal-40	Path
232	Health Point	548/1, Diamond Harbour Road, Behala, Kolkata - 34	Path
233	Health Point Diagnostic Centre	62/3, M.G.Road, Cal-82	Path
234	Health Spot Polyclinic & Diagnostic Centre	126/11, D. H. Road, 1st Floor, Kolkata - 63	Path
235	Health Zone	31A, S. P. Mukherjee Road, Kolkata - 700 025.	Path
236	HEATH CARE DIAGNOSTIC CENTRE	14T , Sreenath Mukherjee Road : Kol: 30	Path
237	Heilen Cross Diag.P.Ltd.	40-A, Hindusthan Park, Cal-29	Path
238	Help & Care Pathological Lab.	8, Kali Bari Lane, Dhakuria, Kol - 31	Path
239	Hematology Clini & Diagnostic Laboratory	3, Sambhunath Pandit Street, Kolkata - 20	Path
240	Herlem Point	56, Chowringhee Road, Cal-16	Path

LIST OF DIAGNOSTIC CENTRES BY DISTRICT

Sl. No	Name of the Units.	Address	Services Catered
241	HINDUSTAN CHARITY TRUST	6B Ultadanga main Road : Kol: 67	Family Welfare
242	Hindusthan Diagnostic Center	Mahamayatala, Garia, Kolkata - 84	Path
243	Horizon Diagnostic Center (P) Ltd.	P-34, Nanigopal Roy Chowdhury Avenue,(C.I.T. Road), Kol-14	Path
244	Human Genetic Engineering Research Center	11, Gangapuri, Purba Putiary ,Cal-93	Path
245	HYATT DIAGNOSTIC CENTRE	51 Syed Amir Ali Avenue : Kol: 19	Path
246	IMMUNO MEDICAL CENT. RES. (P) LTD	185 /1B, NSC Bose Road : Kol: 40	Path
247	IMPLANT HOUSE LASER & DIAG. CENT.	40 A, Beck Bagan Row : Kol: 17	Path
248	Indian Association of Blood Concern & A.D.	81C, Narkeldanga Main Road,Cal-54	Path
249	Indian Vateriaary Research Institute	37, Belgachia Road, Kol - 37	Path
250	INSIGHT DIAGNOSTIC CENTRE	968/2, D H Road, Silpara, Barisha, Kol : 8	Path
251	Institute of Allergic & Immunological Skin Diseases	27/2C, Bakultala Lane, Kasba, Kolkata - 42	Path
252	Institute Of Blood Transfusion, (CentralBlood Bank)	205, Vivekananda Rd,Cal-04	Path
253	ITC Ltd.	93 / 1, Karl Marx Sarani, Kidderpore, Kol - 43	Path
254	J.J. Diagnostic	92, Kabi Nabin Sen Sarani, Kolkata - 700038	Path
255	J.K. Pathological Centre	40A, Darga Road, Kolkata - 700 007	Path
256	JAIN KALYAN SANGHA	265E, Rabindra Sarani : Kol: 7	Path
257	JANAKALYAN:	1, Chandni Chowk Street : Kol; :72	X-Ray, U.S.G.
258	Jeevak	117-A. A.J.C.Bose Road, Cal-14	Collectn Cent,X-
259	Jeevak	31/1, Tangra Road, Kol - 15	Path
260	Jeevan Suraksha Diagnostic Center	42, Badridas Temple Street, Kol - 4	Path
261	James Long Clinic (P) Ltd.	33, James Long Sarani, P.O. & P.S.: Behala, Kol-700 034.	Path
262	JMD MEDICARE LTD	P-335, CIT Road: Scheme : VI M : Kol: 54 ,	Path
263	JUPITER SCAN CENTRE	155/A, A J C Bose Road : Kol: 14	X-Ray, U.S.G.
264	K.C.M. Clinical Digonistic Research Cent.	38, Bechu Chatterjee Street,Cal-09	Path
265	K.C.M.Ultra Sound Clinic	38A, Bechu Chatterjee Street,Cal-09	Path
266	K.M.Clinic	89B, Ballygunge Place,Cal-19	Path
267	KAMAL MEDICAL HALL	2, Jorapukur Lane : Kol: 6	Path,ECG,X-Ray
268	KANCHI SHANKARA MEDICAL CENTER	D-629 (146 / 8E), Lake Gardens : Kol: 45	Path
269	Karim Diag. Centre	13, Haji md. Mahsin Sq. Kol - 16	Path
270	Karunamoyee Laboratories	13/1, M.G. Road, Cal-41	Path
271	Khidirpore Dispensary, C.M.C.	15, Dent Mission Road, Cal-23	Path
272	Kidderpore Clinic	10/D, Kabitirtha Sarani, Cal - 23	Path
273	Kolkata Immuno Medicare	21/12B, Purbachal South Canal Kol - 78	Path
274	Kolkata Pathological Centre	301, Sarat Bose Rd. Kol - 24	Path
275	Kolkata Pathology Center	2/1C, Miajan Ostagar Lane, Kolkata - 17	Path
276	Kumar Surgical & Leproscopy Clinic	235/3/1, N.S.C. Bose Rd.Kol - 47	Path
277	KUMARTOLLY SEVA SAMITY	519A, Rabindra Sarani: Kol: 3	Path,ECG,X-Ray
278	KURUVILLA DIAGNOSTICS :	703 D H Road : Kol: 34	Path
279	KVC Clinic	623/1/B/1, D. H. Road, Behala Manton, Kol - 34	Path
280	Labbaik Pathological Laboratory	40, Kavi Mohammad Eqbal Road, Kolkata - 700 023.	Path
281	Laboratory Centre	148A, N.S.C.Bose Rd. Kol – 40	Path
282	LABORATORY DIAGNOSIS	1, R G Kar Road : Kol: 4	Path
283	Landmark Diagnostics	13B, Bright Street, Kolkata - 700 017	Path
284	Lansdowne Pathology	195B, Sarat Bose Road, Kol - 29	Path

LIST OF DIAGNOSTIC CENTRES BY DISTRICT

Sl. No	Name of the Units.	Address	Services Catered
285	LIFE (A house of Health Care)	94 Topsia Road : Kol: 39	Path
286	Life Care Medical Blood Bank	204/1 B,Linton St. Kol - 14	Blood Bank
287	Life Guard diag & Research Cent.	27, Jhamapukur Lane, Kol - 09	Path,ECG,X-Ray
288	Life Line Diagnostics	9, N.C. Mitra Road, Dum Dum Cantt., Gorabazar, Kol - 02	Path
289	LIFELINE NURSING HOME (It has a Diag)	2, Shyamlal Street : Kol: 4,	Path
290	Lion District 322 B 1 Blood Bank	27/8A, Waterloo Street, Kol - 69	Path
291	Lions Orthop.Resh. Centr	160, NSC.B.R,Cal - 40	Path
292	LOKENATH DIAGNOSTICS	98 B K Pal Avenue : Kol: 5	Path
293	Lokenath Diagnostics	462A, Rabindra Sarani,Cal-05	Path
294	Lokenath Medicare Services	1/1, Haltu Main Road, Kolkata - 700 078	Path
295	Love N Care For Animals	96/1, N.G. Saha Road, Kol - 61	Vatinary
296	M. Bhattacharjee & Co. (Homeo Medi Shop)	133, Bidhan Sarani,Cal-06	Medicine Shop
297	M. F. Diagnostic Center	10, Gomes Lane, Kolkata - 14	Path
298	M. F. Diagnostic Center	10, Kabinabuin Sea Lane, Kolkata - 14	Path
299	M. G. Medicare	126, Bansdroni New Govt. Colony, Bansdroni, Kol - 70	Path
300	M.M.Medical Centre	256,Rash Behari Avenue,Cal-19	Path,ECG,X-Ray
301	MAA DURGA DIAG.CENT.	Good Luck House, P-62 CIT Scheme VII(M): Kol: 54	Path
302	Maa Medicare	514/2, D. H. Road, Vidyasagar Biapni, Behala, Kol - 34	Collection Center
303	Majumdar Clinic Laboratory	3, Chowranghee Square,Cal-72	Path
304	Makali Medical Hall	2, Kalibari Lane,Cal-31	Path
305	Manastala Chest Clinic (KMC)	6, Manshatala Lane,Cal-23	Path, X-Ray
306	MANISHA ULTRASOUND CLINIC	10B CIT Road :Kolkata: 700014	Path
307	Ma-O-Sishu Seva Gabeshana Kendra	127/10, Manicktala Main Road, Kolkata - 54	Path
308	Mayor's Chest Clinic (Tollygunj Unit) (KMC)	Lalka Road, Kol - 92 (Between Ranikuthi & Baghajatin)	Path, X-Ray
309	Mayor's TB Clinic	15/1, Gobinda Khatick Road, Kolkata – 700 046	Path, X-Ray
310	Medassure Diagnostic & Clinic	38, Ganesh Chandra Avenue, Kolkata - 13	Path
311	Medi Aid	9, Anandapally, Jadavpur,Cal-32	Path
312	Medi Base Health Care (P) Ltd.	180/A, D. H. Road, Sarkar Bazar, Kol - 8	Path
313	Medi Lab.	23, Raja S.C.Mallick Road,Cal-84	Path
314	Medicade Diagnostic Centre	17/27, N. S. C. Bose Road, Kol - 40	Path
315	Medical Aid Centre	42,Biren Roy Road(E),Cal-8	Path, E.C.G,
316	Medical Bank (A unit of Hathkhola Institute)	7, Rasik Lal Ghosh Lane, Cal-05	Path, USG, ECG
317	MEDICAL LAB& CLINIC P. LTD.	497/D, Block M, New Alipore, Kol - 53,	Path
318	Medicare & Polyclinic	126, Bansdroni New Govt. Colony, Bansdroni, Kol - 70	Path
319	Medicare Center	19/2, Banamali Naskar Road, Kolkata - 700060	Path
320	Medicare Clinic	57, Rash Behari Avenue,Cal-26	Doctor's Chamber
321	Medicave Diag. Centre	48B, B.T.Road, Cal-50	Path
322	Mediclue Research & Diagnostic Pvt. Ltd.	68 Chowrenghee Road Kol - 20	Path
323	Medicos Clinical Laboratory	21, Kalakar Street, Cal-07	Path
324	Mediland Diag. Res. Inst.	7, Panditya Place, Kol - 29	Path
325	Medilink	138A, D.H. Road, Kol - 63	Collection Center
326	Medilink Diagnostic.	1/2A/1H, R. K. Naskar Lane, Kol - 10	Path

LIST OF DIAGNOSTIC CENTRES BY DISTRICT

Sl. No	Name of the Units.	Address	Services Catered
327	Medinova Diagnostic Services Ltd.	1, Sarat Chatterjee Avenue, Cal-29	Path, ECG, X-Ray
328	Medipath	34A, Raja Nabakrishna St. Cal-05	Path
329	MEDIPIYX	P-219 Lake Terrace Extn: Kol: 29	Path
330	MEDISCAN	455, D H Road : Kol: 34	U.S.G
331	MEDISEARCH DIAGNOSTIC CENTRE	596B, Parnasree Pally : Kol: 60	Path
332	Mediview Clinic & Reas Cent. Pvt. Ltd.	74, Broad St. Kol - 19	Path
333	Mediview Clinic Pvt. Ltd.(CLOSED)	4D / 1, Tollygunge Circular Road, Kol - 19	Path
334	Medstar Clinic Pvt. Ltd.	39, Shakespeare Sarani, Kol - 17	Path
335	Meenakshi Diagnostic Centre	785, D.H.Road, Cal-08	Path
336	MEERA XRAY & DIAGNOSTIC CLINIC	48/D, B T Road : Kol: 50	Path
337	Megha Clinic	6A, Rani Bhabani Road, Kol - 26	Path
338	Mentaur Health Care Pvt. Ltd.	57/14 Ballygunge Circular Road : Kol: 19	Poly Clinic, Physio
339	METIBURZJ MEDICAL CENTRE	P-2, Garden Reach Road : Kol: 24	Path
340	METIBURZJ MEDICAL CENTRE :	N-7, Paharpur Road : Kol: 24	Path
341	METROPOLITAN DIAG.XRAY CLINIC & LAB.	6B, Parboti Chakraborty Lane, Kol: 26	Path, X-Ray
342	Metropolitan Medical Center	48, Kustia Masjid Bari Lane, Kolkata - 39	Path
343	MICROLAB	52, HalderPara Road : Kol: 26	Path
344	MICROVIEW LABORATORY & CLINIC	18 A, Sree Mohan Lane Kol: 26 :	Path
345	Miracle	Santoshpur, P.O. & P.S.: Bidhannagar,	Path
346	MM DIAGNOSTIC CENTRE	1E G J Khan Road : Kol:39	X-Ray
347	Modern Clinic	1/A, Grant Street, Cal-13	Path
348	MODERN DIAG. CLINICAL LAB.	1375/N, Vidyasagar Saranim, Kol: 63	Path
349	Modern Diagnostic	72, R.A.Kidawai Road, Cal-16	Path
350	MODERN EYE SCAN & LASER CENTRE	95A, Chittaranjan Avenue : Kol: 73	Doctor's Chamber
351	Mohini Diagnostic Center	35B, Deshpran shasmal Road, Kol - 33	Path
352	Molecular Research & Investigation Centre	45, Shakespeare Sarani, Kolkata - 700 017.	Path
353	MOMINPUR XRAY CLINIC & DIAGNOSTIC Center	136, Jyotish Roy Road, Kolkata - 53	Path
354	MOMINPUR XRAY CLINIC:	46/1B, Diamond Harbour Road : Kol:27	X-Ray
355	Mondal Dental Hall	61/8, Stn.Road, Cal-31	Dental Withchair
356	MONI XRAY HALL	210/1A, R B Avenue : Kol: 29	X-Ray, U.S.G.
357	MONTU"S CLINIC (Physiotherapy Centre)	1/T, Chhatu Babu lane : Kol: 14	Physiotherapy
358	Moonlight Diagnostic Center	69/2/3, Biren Roy Road (East), Kol - 41	Path
359	Mou Diagnostics	117 / 1 Garden Reach Rd, Kol - 24, 24698674	Path
360	Narendra Seva Trust	26, Gariahat Road Kolkata - 31	Path
361	National Carbon Plant	5, Rustomji Parsee Road, Cossipore, Kol - 2	Path
362	National Clinic	4, Sadananda Road, Cal-26	Path
363	National Homeo Laboratory(Medicine Lab.)	110, A.J.C.Bose Road, Cal-14 ,	Medi. Manufacturer
364	NEEL KUTHI MEDICAL COMPLEX	48/2M, B T Road : Kol: 700 050	Path
365	Neo Bacto Clinical Laboratories (P) Ltd.	46, Park Street, Kol - 16	Path
366	Neo Clinic & Diagnostic ,	B 71, Garden Reach Road, Kol - 24	Path, ECG, X-Ray
367	Neotia Elbit Hospital Vnture Ltd.	86C, Topsia Road (S), Kolkata - 700 046	Poly Clinic
368	New Dum Dum Clinical Laboratory	54, Bipin Ganguly Road, Kolkata - 700 020.	Path
369	New East Calcutta Lab.	36A, Kalimuddin Sarkar Lane, Cal-10 ,	Path

LIST OF DIAGNOSTIC CENTRES BY DISTRICT

Sl. No	Name of the Units.	Address	Services Catered
370	New Hayat Medical Center	18, Free School Street, Kol - 700 016	Path
371	NEW HEALTH CARE LABORATORY	100A, Ashutosh Mukherjee Road : Kol: 25	Path
372	NEW JANAKAKYAN LAB. & XRAY	1, Jatindra Mohan Avenue : Kol: 6	Path
373	New Scientific Clinical Laboratory	382/N, M.G.Road, Cal-82	Path
374	NEW SWASTI CLINIC WELFARE SOCIETY	28/1A, Nakuleshwar Bhattacharjee Lane, Kol: 26	Path
375	Nidan Clinic Diagnostic Laboratory	13A+B, Rama Nath Paul Road, Cal-23	Path
376	NIDAN CLINICAL LAB. CO.PVT.LTD.	21, Kalibari Lane Kol: 31	Path,X-Ray,USG
377	Nigtenangle Diag Eye Care Res. Cent	11,Shakespeare Sarani Kol - 71	Path
378	Nilam The Pathology Lab	56, Lower Range Kol - 19	Path
379	Nirikshan Collection Centre	103, Belgachia Road, Cal-37	Doctor's Chamber
380	Nirmayan Patho. Lab	27/1C. C.I.T.Rd, Kol - 14	Path
381	NIRNOY Computerised Path Test	226A & B, A.P.C.Road, Cal-04	Path
382	NIRNOY DIAG. CENTRE	D/127 Ramgarh : Kol: 47	Path, X-Ray
383	Nirog M. R. I.	155/A, A.J.C.Bose Road, Cal-14	MRI,
384	NIROG MR DIAGNOSTIC CENTRE Pvt. Ltd.	6, Ho Chi Minh Sarani : Kol: 71	Path
385	North Calcutta Scan Centre	P-41 Kshirode Vidyavinode Avenue : Kolkata –70003	Path,X-ry, USG,ECG
386	NORTH CITY DIAG.&RES.CENT.P. LTD.	35A, Canal West Road : Kol: 4	Path
387	North Point Diagnostic Center	119, Sri Arobinda Sarani, Kol - 08	Path
388	Northern Clinical Lab	T/14N/1C, Dum Dum Road, Cal-30	Path
389	NOVA	2/5A, Sarat Bose Road (Gr. Fl.): Sukh Sagar: Kolkata: 20	Laser Treatment
390	NPC Medical Sciences & Research Foundation	27, Weston Street, Kol - 12	Path
391	NS SCINTIFIC IMMUNOASSAY PVT.LTD	7 Puran Chandra Nahar avenue: Kol:13	Path
392	OPD Day Care Center of Punjabee Bradree	7, Shaheed Baghat Singh Sarani, Kol - 19	Path
393	Oral & Maxillofacial Pathology Clinic	3, Raja Manindra Road : Kol: 37	Path
394	Oral Cancer Foundation (KOLKATA)	93/3A/1, A.P.C. Road, Kol - 9	Path
395	Organ Histology & Cytology Res. Cent.	3A, Tara Road Kol - 26	Path
396	Orion Immunogenics (P) Ltd.	155A, A.J.C. Bose Road, Kol - 14	Path
397	Orocare Dental Clinic	46B, Chakraberia Road (South), Kol - 25	Path
398	Palsons Drugs & Chemical Industries	10/D/1, Ho-Chi_Minh Sarani, Kolkata - 700 071	Path
399	Paramount Clinic	90A, Beltala Road, Kol - 26	Path
400	Park Diagnostic Centre Pathology	204/1, Linton Street, Cal-14	Path
401	Park Poly Clinic	207/B, Park Street, Cal-17	Path
402	PARK Xray CLINIC:	4, Gorky Terrace: Kol:17	X-Ray
403	Parkview Clinic	25A, Lansdown, Cal-26	Doctor's Chamber
404	Parkview Clinic Cum Research Lab (P) Ltd.	21A, Gora Chand Lane, Kolkata - 700 014	Path
405	Path Study	15A, Kalighat Road, Cal – 26	Path, E.C.G,
406	Patho Care Clinical Laboratory	38 G, Chakraberia Road (S), Kol - 25	Path
407	PATHOCLINICAL LABORATORY (separate Unit)	14B, Gobinda Sen lane : Kol: 12	Path
408	PATHOCLINICAL LABORATORY (separate Unit)	15, Gobinda Sen lane : Kol: 13	Collection Center
409	PATHOWYND-CLINICAL & RES.LAB.	29A, Balaram Ghosh street: Kol: 4	Path
410	Pavlov Clinical Laboratory	1/1, Rani Debendrabala Rd, Cal-3	Path
411	PEERLESS Hospital City DIAGNOSTIC CENTRE	223 C R Avenue : Kol: 6	Path

LIST OF DIAGNOSTIC CENTRES BY DISTRICT

Sl. No	Name of the Units.	Address	Services Catered
412	Peerless Poly Clinic	5/2, Fukir Dey Lane, Cal-12	X-Ray, U.S.G.
413	Peerless Polyclinic	5/3-A, Dum Dum Road, Cal-30	Path, X-Ray, USG
414	People's Relief Committee	26C, Dilkhusa Street, Kol - 17	Path
415	Peoples Blood Bank	90A, S.P.Mukherjee Road, Cal – 26	Blood Bank
416	Peoples Clinical Laboratory Pvt. Ltd.	90A, S.P.Mukherjee Avenue, Cal – 26	Path
417	PHEARS LABORATORY	4, Black Burn Lane : Kol: 12	Path, E.C.G,
418	Plasma Diagnostic Center	22C, Gora Chand Road, Kolkata - 14	Path
419	Poonam Pharma (p) Ltd.	26, D. H. Road, Kol - 38	Path
420	PRANABANDA SEBA NIKETAN	237 Rash Behari Avenue: Kol: 19	Path, X-ry, USG, ECG
421	PRATHAMESH PATHOLOGY CLINIC	46, Raja S C Mullick Road Kol: 32	Path
422	Pratima Debi Memorial Medi Lab Diag.	115/2-A, A.J.C.Bose Road, Cal-14	Path
423	Precision Diagnostic Clinic	7A, Kalimohan Banerjee lane, Cal-26	Path
424	PROBE Diag.Res.Cent& Lab.	121/A, A.J.C.Bose Road, Cal-14.	Path
425	Pulse Diag.Res.Cent.P.Ltd	33A, Sd.Amir Ali Avn. Kol – 17	Path, X-ry, USG, ECG
426	PULSE DIAGNOSTICS (P) Ltd.	2, Rowdon Street, (1st Floor), Kol: 17	Path, X-ry, USG, ECG
427	Purwanchal Nagarik Samity	P-73, CIT Scheme, VIM, Kol - 54	Path
428	Puspanjali	72, Nalini Sett Road, Kol - 07	Path
429	QUADRA MEDICAL SERVICES PVT.LTD.	41, Hazra Road : Kol: 19	Path
430	R S DIAGNOSTIC LAB	114 T Beliaghata Main Rd, Kol 10	Path
431	R. K. Medical Center	16/3, Hindusthan Road, Kol - 29	Path
432	R. M. Clinical & Research Laboratory	23/37, Gariahat Road, Cal-29	Path, X-ry, USG, ECG
433	R.C.Sen Clinic	P- 404/7A , Gariahat Road, Cal-29	Path
434	RABINDRA MEDICAL CENTRE	5, Raja S C Mullick Road : Kol: 32:	X-Ray, USG, E.C.G
435	Radha Clinical Laboratory	743, D.H.Road, Cal-8	Path
436	RADIOASSAY	98, Dr Sundari Mohan Avenue: Kol: 14	Path
437	Raj Krishna Diagnostic Lab. & X-Ray Cl.	127-C, Raja S.C.Mullick Road, Cal-47	Path
438	Ramkrishna Clinical Lab.	44/1, Nilmani Mitra St. Kol - 06	Path
439	Ramkrishna Day Care Center & Polyclinic	2B, Bedon Street, Kol - 06	Path
440	Red Plus Society	22, Baghajatis Station Road, Kol - 32	Path
441	Regent Diagnostic Centre	174/2, N.S.C.Bose Road, Cal-40	Path
442	Regent Estate Dispensary, (Central Govt. Health	102, Regent Estate, Kolkata – 700032.	Path
443	Reliance Medi Care	85/2E, Ripon Street, Kol - 16	Path
444	RELY ON US DIAG.& RES.CENT.	P:6, Suhrawardy Avenue: Kol: 17	Path
445	Remedy	91A, Dr. L.M. Bhattacharya Road, Kolkata - 700 014	Polyclinic & Path.
446	Repromed Diag. Pvt. Ltd.	21/2A Gora Chand Rd. Kol - 14	Path
447	Review Diagnostics	13/3B, Raja Manindra Road, Kolkata - 700 037.	Path
448	Riddhi Seva Kendra	63/1, Dhakuria Stn. Road, Cal- 31	Doctor's Chamber
449	RISHI HEALTH CARE & RES. INST.P,LTD.	3/101, C R Colony :Kajipara :Baghajatin, Kol:32	Path
450	RITTIK Clinic Research Lab.	155 A, A.J.C.Bose Road, Cal-14	Path
451	Roop Polyclinic & Diagnostic Center	148/9, NS.C. Bose Road, Kol - 40	Path

LIST OF DIAGNOSTIC CENTRES BY DISTRICT

Sl. No	Name of the Units.	Address	Services Catered
452	Ross Clinical Laboratory	114A, Ashutosh Mukherjee Road, Kol - 25	Path
453	ROY'S INVESTIGATION CENTRE	G 11, Gariahat Market (212 R B Avenue) Kol: 19	Path
454	S.K. Ghosh Memorial Clinic	124 Rasbehari Avenue, Kolkata - 700 029	Path
455	S. R. G. Upasom	170, D. H. Road, Thakurpukur, Kolkata - 63	Path
456	SAB'S CLINIC	2A Chittaranjan Avenue: Kol: 72	Path,ECG,X-Ray
457	Sagarika Clinic	2B, W. C. Banerjee Street, Kol - 06	Path
458	Saini Diagnostic Centre	8/A, Hari Mohan Ghosh Road, Kolkata - 700 024	Path
459	SANJIBAN DIAG.& MEDI.RES.PVT.LTD.	4, Satyen Roy Road, Kol: 34	Path
460	Sanjivani Diagnostic Center	106/1A, S. N. Banerjee Road, Kol - 14	Path
461	Santosh Clinic	38U, Sultan Alam Road Kol - 33	Path
462	Sarada Patho Clinical Lab.	42/1, Dhakuria Stn.Road,Cal-31	Path
463	SARAJU XRAY CLINIC	46/1G, B T Road : Kolkata:2	X-Ray
464	Scanex	633, Biren Roy Road (W), Kol - 61	Path
465	School of Medical Technology	24, Girish Chandra Bose Road, Kolkata - 700 014	Path
466	Scientific Clinical Research Lab	2,Ram Chandra Das Row, Cal-13	Path
467	Scientific Laboratory	140/11, N.S.C.Bose Road,Cal-40	Path
468	Search Diagnostic Center	38, Raipur,Cal-84	Path
469	Sebakendra Poly Clinic	79A,Raja S.C.Mullick Rd. Kol – 84	Path, E.C.G,
470	Sebayan Meditech Medical Service	4, Panchanantala Lane, P.O.: Behala, Kolkata - 700 034.	Path
471	Sen Diagnostic (P) Ltd.	40, Luhsun Sarani, (Phears Lane), Kolkata - 700 012	Path
472	Sero Bacterological Lab	P-42,Khirode Bidya Binod Avn.C-03	Path
473	SERUM ANALYSIS CENTRE	13/1, Bhupen Bose Avenue : Kol: 4	Path
474	Sethi Diagnostic Medicare	69,D. H. Road,Cal-34	Path,X-ry, USG,ECG
475	Seva Centre	92A, D.H.Road, Kol - 23	Path
476	SEVA MEDICAL DIAG & RES CENT	127 Hemchandra Naskar Road Kol: 10	Path,X-ry, USG,ECG
477	Shaw Opomedics (P) Ltd.	146, Bidhan Sarani, Kolkata - 6	Path
478	Shibapan Diagnostic Centre	38, Raipur,Cal-84	Path
479	SHREEJI IMAGING CLINIC	38 D, Ramesh Mitra Road Kol: 25	U.S.G
480	Shusrut	3G, Naskarpara Lane, Kol - 31	Path
481	SHYAM PATH	392/D, Rabindra Sarani : Kol: 6	Path
482	Smile & Profile Dental Treatment Center (P) Ltd.	144A, Rash Behari Avenue, Kol - 29	Dental Withchair
483	Smile & Profile Dental Treatment Center (P) Ltd.	1458, Gartia Main Road, 1st Floor, Garia. Kolkata - 700084	Dental Withchair
484	Social Welfare Organisation Health Cent & Path	88/2, Rafi Ahmed Kidwai Road : Kol: 13	Path, U.S.G.
485	Social Welfare Organisation Health Cent & Path	88/2A, Rafi Ahmed Kidwai Road : Kol: 13	Out Door
486	SONO DIAGNOSTICS	190 A, Rash Behari Avenue Kol - 29	U.S.G
487	SONOLINE , Dr Kalyan Paul's Clinic :	77/1, Simla Street : Kol: 6	Path
488	South Calcutta Dental Hospital	154, S.P.Mukherjee Road,Cal-26	Path
489	SOUTH Calcutta SARADESWARI DENTAL CLINIC	73, D H Rd, Sakher Bazar Kol: 8	Path
490	South City Care Polyclinic & Digo centre	23B/40/1A, Blk-B,N.Alipore,Cal-53	Path
491	South Diagnostic Center	738, D. H. Road, Chowrastha, Kolkata - 8	Path
492	SOUTH END CLINIC	11, Raja SC Mullick Road Kol - 84	Path
493	South Kolkata Matri O Sishu Kalyan Samity	111B, Shyama Prasad Mukherjee Reoad:Kol:26	Family Welfare

LIST OF DIAGNOSTIC CENTRES BY DISTRICT

Sl. No	Name of the Units.	Address	Services Catered
494	South Kolkata Matri O Sishu Kalyan Samity (North Center)	28/2, Jhamapukur Lane : Kol: 9	Family Welfare
495	SOUTH POINT CLINICAL LAB	11/2, Maya Dasi Road : Behala : Kol: 60	Path
496	South View Clinical Lab.	307, Upen Banerjee Road Kol - 88	Path
497	SOUTHERN DIAGNOSTIC CENTRE	362 D H Road : Kol: 34	Path,X-Ray,USG
498	Southern Diagnostic Laboratory	489, Diamon Harbour Road, Kolkata - 34	Path
499	SOUTHERN DIAGNOSTICS	3, Dabur park: Ganguly Bagan : Kol: 84	Path
500	Southern Investigation (Laboratory)	18/11, Ballygunge Place (E), Cal – 19	Path, X-ray
501	Southern Polly Clinic	203, Sarat Bose Road,Cal-29	Path
502	SPANDAN DIAGNOSTIC POINT	3/A, Raicharan Sadhukhan Road : Kol: 4	Path, X-Ray
503	Specialist Corner & Diagnostic Laboratory	90, Santoshpur Avenue,Cal-75	Path, X-Ray
504	Specialist PolyClinic	107,Jadavpur Station Rd., Kol – 32	Path
505	Spectrum Clinic & Endoscopy Res. Inst.	28B, Shekespeare Sarani Kol - 17	Path
506	Spectrum Diagnostic Centre	2, Ashutosh Mukherjee Road, Kolkata - 700 020	Path
507	Spectrum Haematology Research Center	P-30, C.I.T. Road, Scheme-10M, Kolkata - 10	Path
508	Spiral Diagnostics Pvt.Ltd.	282,Rabindra Sarani,Cal-07	Path
509	Sree Guru Diagnostic Center	48, B.T.Road,Cal-02	Path,X-ry,USG,ECG
510	Sri Aurobinda Medicare	2/1 Kalibari Lane, Kolkata - 45	Path
511	Sri Krishna Pranami Janakalyan Trust	35A, 1C, Motilala basak Lane : Kol; 54	Path
512	Sristi	136/1, Bidhan Sarani Kol - 04	Path
513	SRL PATHOLOGY CLINIC	311/10A, Prince Anwar Shah Road : Kol:95	Path
514	SRL PATHOLOGY CLINIC	311/5, Prince Anwar Shah Road, Lake Gardens, Kolkata - 95	Path
515	SRL Ranbaxy Ltd	30B , J. L. Neheru Road Kol - 16	Path
516	Standard Clinical Lab	522,D.H.Rd., Kolkata – 34	Path
517	STAR CLINIC	124/1/B, Sarat Bose Road Kol: 29	Path
518	State Forensic Laboratory	37/1/2, Belgachia Road, Kol - 37	Forensic Lab
519	Students Health Home	142/2, A. J. C. Bose Road, Kol - 14	Path
520	Subarna Banik Samaj Poly Clinic	47, Ganesh Ch. Avenue. Kol - 13	Path, X-Ray
521	Subhasis Diagnostic	117, Baithakkhana Road, Kolkata – 700 009	Path
522	Suniti Diagnostic & Res. Cent.	25A, Rajendralala St. Kol - 06	Path
523	SUR DIAGNOSTICS PVT. LTD.	623/1-F, D H road : Kol: 34	Path
524	Suraksha Diag & Eye Res. P. Ltd.	P - 118, CIT Rd.Scheme - VIM Kol - 54	Path
525	Surgy Centre	149/4, Biren Roy Rd (West), Bakultala, Cal-61	U.S.G
526	SUSWASTHA DIAGNOSTIC PVT. LTD.:T	T - 48, Sree Mohan Lane : Kol: 26	Path
527	SUSWASTHA DIAGNOSTIC Centre	42/72/1, D Bebiadanya 2nd Lane, Klokata - 700 039	Path
528	Sutanati Manab Kalyan Samity	43/1B, Nimtola Ghat Street, Kol - 06	Path
529	Swasti Clinical Res.Lab.(Pvt) Ltd.	89, Sarat Bose Road,Cal-26	Path
530	Swastic Medicare	31, Picnic Garden Road, Kol - 39	Path
531	Taheri Diagnostic Centre	60, Rippon Street,Cal-16	Path, U.S.G.
532	Talapark Clinical Complex	26/C, Raja Manindra Road, Kol - 37	Path
533	Tech Lab	13/1C, Balaram Ghosh Street, Kolkata - 4	Path
534	THE CALCUTTA CLINICAL LAB	51/8, Rai Bahadur Road: Kol: 34	Path
535	THE CALCUTTA CLINIC-GASTRO	:2/5, Sarat Bose Road: Kol: 20, Sukhsagar (1st Floor)	Path, USG, ECG

LIST OF DIAGNOSTIC CENTRES BY DISTRICT

Sl. No	Name of the Units.	Address	Services Catered
536	The Calcutta Clinic - Gastro	7/1, Lord Sinha Road, Kolkata - 700 071	Polyclinic & Path.
537	THE DIAGNOSTIC CLINICAL LAB	107, Dr. K. S. Roy Road (2nd Floor), Kol: 32	Path
538	The Diagnostic Laboratory	4/A, Banamali Naskar Road, Behala, Kolkata - 60	Path
539	The Life Health care Diagnostic Centre	13B, Radhanath Mullick Lane, Kolkata - 700 012	Path
540	THE MEDIPATH	20 Raja Naba Krishna Street : Kol: 5	X-Ray, E.C.G
541	THE RELIEF	226/A, APC Road : Kol;4	X-Ray
542	THEISM POLYCLINIC	3A/6, B K Pal Avenue: Kol: 30	Doctor's Chamber
543	Theism Ultra-Sound Centre	16B, Dum Dum Road,Cal-30	Path
544	Thelasamia Hosp.	19B, Chetlahat Road Kol - 27	Path
545	Tiss Path Lab. & Clinic	48/55, Swiss Park,Cal-33	Path
546	Tollygunge Polly clinic	4/1, Moore Avenue,Cal-40	Path,X-ry,USG,ECG
547	Toronto Calcutta Association Cal-Chap	2/45, Naktala,Cal-47	Path
548	TRIBENI Clinical Lab	P-323 CIT Road Scheme:6M, Kankurgachi: Kol: 54	Path
549	TRISTAR LAB	P-198 CIT Road : SchNo:IV(M): Kol: 10	Path
550	TROPICAL CLINICS	2C, Tarachand Dutta Street Kol - 73	Path, X-Ray
551	Ultra Clinical Laboratory	5B, Karbala Tank Rd,Cal-06	Path
552	ULTRA DIAGNOSTIC & RES, CENTRE	151 D H Road : Kol: 34	U.S.G
553	Ultra X-ray Clinic	23, Vivekananda Road,Cal-07	X-Ray
554	ULTRASOUND DIAGNOSTIC CENTRE	227 A J C Bose Road : Kol: 20	U.S.G
555	Uma Polyclinic	12, Vivekananda Road,Cal-07	Path
556	UNIQUE MEDICAL SERVICES	46/1, Raja S C Mullick Rd : Kol: 32	X-Ray
557	UNIQUE XRAY CLINIC	16/M, Manohar Pukur Rd Kol: 26	X-Ray, U.S.G.
558	United Laboratory	123,Karl Marx Sarani Kol - 23	Path
559	Upkar Diagnostic Centre	31, College Street, Kolkata - 700 073	Path
560	URANUS MEDICAL CENTRE	B-185, Survey Park: Santoshpur: Kol: 75	Path,X-ry, USG,ECG
561	Vasundhara Delear (P) Ltd.	234/3A, AJC Bose Road, Kolkata - 700 020	Polyclinic & Path.
562	Venus Diagnostic Center	58/4, Raja Dinendra Street, Kol - 6	Path
563	Venus Diagnostic Laboratory	163,D.H.Road, Cal – 34	Path
564	VENUS X RAY:	163 D H Road : Kol: 34 (1st Floor)	X-Ray
565	VICTOR HEALTH CLINIC (P) LTD:	93A, Rash Behari Avenue Kol: 26	Path
566	WELCOME Dg & Thyroid Testing Centre	161 Banamali Naskar Rd : Kol:60	Path
567	WELLESLEY MEDICENTRE	44A, Rafi Ahmed Kidwai Road : Kol: 16	Path
568	Western Diagnostic & Research Centre.	10B,Shakespear Sarani,Cal-71	Path
569	Wimco Ltd.	P.O.: Alambazar, Kolkata - 700 035	Path
570	WOCKHARDT MEDICAL CENTRE	2/7 Sarat Bose Road : Kol: 20	Path
571	World Dental Center	153, Rash Behari Avenue, Kol - 29	Dental With chair
572	X RAY CLINIC	120 B/1B, AJC Bose Road Kol 14	X-Ray
573	X-Ray & Medical Relief Centre	213, B.B.Ganguly Street,Cal-12	Path
574	X-Ray Centre	14H, Dum Dum Road,Cal-30	Doctor's Chamber
575	XRAY CLINIC & ULTRASOUND SCAN CENTRE	130/1, B K pal Avenue : Kol: 5	X-Ray, U.S.G.

LIST OF DIAGNOSTIC CENTRES BY DISTRICT

Sl. No	Name of the Units.	Address	Services Catered
576	ZENITH CLINIC:	19/1, BaluHakkak Lane : Kol: 17	Path
577	Perfect Dignostic Centre	16, Kustia Road, Kolkata - 39	Diagnostic Centre
578	The Orthopadic & Fractura Clinic	15/2, Sarat Bose Road, Kolkata - 20	Orttho. Clinic
579	Advance Medicare & Research Institute Ltd.	38/1A, Gariahat Road, Kolkata -29	Path & Clinic
580	Park Circus Diagnostic Centre	100A, Jhawtala Road, Ward No. 64, Kolkata - 7	Collection Center
581	The Mediscan	82A, Chowranghee Road, Ward No. 70, Kolkata - 20	Path
582	Western Diagnostic Centre.	20, Ashutosh Mukherjee Road, Kolkata - 20	Radiology
583	Apollo X-Ray	116/1, MG Road, Kolkata - 7	Path
584	Special Assay Clinic	97A, APC Road, Ward No. 38, Kolkata - 9	Path
585	Jeevan Suraksha Diagnostic Center	6B, Rajdanga Gold Park, kolkata -107	Path
586	SRL Ranbaxy Ltd	30B, Chowranghee Mansion, Kolkata - 16	Path
587	Dey's Eye Center		Eye Care
588	Central Blood Bank	Manicktala	Blood Bank
Numbers of Path Lab: 474; Blood Bank: 5 ; Dental Clinic: 11 ; Forensic Lab: 2 ; Collection Centre: 10; Eye: 1			
MALDA			
1	Aritra Diagnostic Center	K.J. Sanyal Road, Mukdumpur, Malda	Path
2	B.R. Diagnostic Center (P) Ltd.	Old fire Brigade Station House, South Singatala, Malda	Path
3	Central Pahtological Lab.	Ratua Maxi Stand, Malda	Path
4	Chanchal Medicare & Diagnostic Center	Taratala, P.O.: Chanchal, Malda	Path
5	Chatterjee Pathology	Chanchal, Malda	Path
6	Gazol Diagnostic Center	P.O. & P.S.: Gazol, Malda	Path
7	Harishchandrapur X-Ray Clinic	Malda	Path
8	Jiban Sudha X-Ray Clinic	College Road, Chanchal, Malda	X-Ray
9	Karmakar X-Ray Clinic & Pathological Lab.	Singatala, Malda	Path
10	New Medilab	T.B.D. Lane, Mukdumpur, P.O.: Malda, English Bazar, Malda	Path
11	Nirmay (KBS Medicare Pvt.. Ltd.)	Chanchal, Malda	Path
12	Roy Medical Research Institute	Malda	Path
13	Saba Diagnostic Center	Pirajpur (N), Malda	Path
14	Sahara Pathological Center	Madipukur (Hospital Road), P.O.: Maheshpur, P.S.: Bamangola,	Path
15	Sebayan Scanning Center	Chanchal (Sibmandir), Malda	Path
16	Sevayan X-Ray Clinic	P.O.: Chanchal, Malda	X-Ray
17	Somnath Pathological Clinic	K.J. Sanyal Road, Mukdumpur, Malda	Path
18	Sono Scan Diagnostic Center	B. G. Road, Mokdumpur, Malda	Path
19	The Suraksha	Malda	Path
Numbers of Path Lab: 17; Blood Bank: 0 ; Dental Clinic: 0 ; Forensic Lab: 0 ;			
MURSHIDABAD			
1	Amtala Diagnostic Center	Amtala Hospital Road, P.O.; Amtala, P.S.: Nowda, Murshidabad	Path
2	Angel Diagnostic Center	1, Old Police Line Road, P.O. & P.S.: Berhampur, Murshidabad	Path
3	Ani Clinical Laboratory	Lalbag, Murshidabad	Path
4	Annapurna Diagnostic Center	Raninagar, Murshidabad	Path

LIST OF DIAGNOSTIC CENTRES BY DISTRICT

Sl. No	Name of the Units.	Address	Services Catered
5	Apex Diagnostics	K.N. Road, Berhampur, Murshidabad	Path
6	Ashadeep Diagnostic	Nowda, Murshidabad	Path
7	Ashadeep Diagnostic Center	Raghunathgunj, Murshidabad	Path
8	Astha Diagnostic Center	Laldighi, Berhampore, Murshidabad	Path
9	Astha Pathological Laboratory	Hariharpara (Hospital More), Murshidabad	Path
10	B.B. Diagnostic Center	Berhampore, Murshidabad	Path
11	B.C. Dhar Dental Polyclinic	35, R. M. Sen Road, Berhampur, Murshidabad	Path
12	Bacto Clinical Lab.	Beniagram, Murshidabad	Path
13	Behara Pathological Laboratory	Kandi, Murshidabad	Path
14	Beldanga Ultrasonography Center	Bazar Road, Baroyaritola, Murshidabad	U.S.G
15	Berhampore Diagnostic Laboratory	46/1, K. N. Road, P.O. & P.S.: Berhampore, Murshidabad	Path
16	Berhampore Pathological Laboratory	Berhampore, Murshidabad	Path
17	Berhampore TMT Center	Berhampore, Murshidabad	Path
18	Berhampore X-Ray Clinic	Berhanpore, Murshidabad	X-Ray
19	Bhagirathi X-Ray Clinic	Berhampore, Murshidabad	X-Ray
20	Bhai Bhai Diagnostic Center	Baganbari, Raghunathganj, Murshidabad	Path, X-Ray
21	Bioline Diagnostic Center	Vill & P.O.: Bharatpur, Murshidabad	Path
22	Biotron Diagnostic Center	Berhampore, Murshidabad	Path
23	Biswas Clinical laboratory	Golapbagh, Lalbagh, Murshidabad	Path
24	Biswas Pathological Laboratory	Amtala, Murshidabad	Path
25	Chandana X-Ray & Ultrasonography	92/6, Pilkhana Road, Berhampore, Murshidabad	Path
26	Chandra Pathological Laboratory	Berhampore, Murshidabad	Path
27	Chintamony Pathological Laboratory	11/5/F, K.K. Banerjee Road, Berhampore, Murshidabad	Path
28	Dafodil Medicare Center	25/26, Sahid Surya Sen Road, Berhampore, Murshidabad	Path
29	Das Pathological Laboratory	Kandi, Murshidabad	Path
30	Dey Pathological Center	Raninagar, Murshidabad	Path
31	Dhanwantari Diagnostic Center	Kandi Hospital Road, Murshidabad	Path
32	Dhar X-Ray Clinic & Diagnostic Center	Natun Jaladipara, Jiagunj, Murshidabad	Path, X-Ray
33	Dhulian USG Center	Biswas Market, Dhulian Main Road, Murshidabad	U.S.G
34	Diagnostic Center	Khargram, Murshidabad	Path
35	Diagnostic Center & Clinic	Vill.: Bablabone, P.O.: Rosulpur, P.S.: Domkol, Murshidabad	Path
36	Diagnostic Center X-Ray Clinic	Kandi, Murshidabad	Path
37	Diagnostic Pathological Laboratory	Saktipur, Kandi, Murshidabad	Path
38	Disha Diagnostics	Stall No.: 54, Netaji Road, Berampur, Murshidabad	Path
39	Dolphin Diagnostic Center	Burwan, Murshidabad	Path
40	Domkol Vikash Kendra	Domkal, Murshidabad	Path, X-Ray
41	Doyen Diagnostic & Research Foundation	Krishnapur R.H., Krishnapur, Mursidabad	Path
42	Dr. Banerjee & Islam PathoLab.	1/1, R. N. Tagor Road, Berhampore, Murshidabad	Path
43	Dr. Indranils Lab	Laldighi, Murshidabad	Path
44	Dr. Nihar Mukherjee Pathological Laboratory	11, Radhika Mohan Road, Berhamore, Murshidabad	Path
45	Dr. P. Banerjee's U.S.G. Chamber,	66/2, R. N. Tagore Road, P.O. & P.S. & P.S.: Berhampore,	U.S.G
46	Dr. P. Pramanik's Patholab	1/5, K.K. Banerjee Road, Gorabazar, Berhampore, Murshidabad	Path
47	Dr. Subrata Saudagar Path Lab.	Beldanga, Murshidabad	Path
48	Dutta X-Ray Clinic	Berhampore, Murshidabad	Path
49	Eden X-Ray Center	Lalbag, Murshidabad	X-Ray

LIST OF DIAGNOSTIC CENTRES BY DISTRICT

Sl. No	Name of the Units.	Address	Services Catered
50	EKO-Ultrasound Clinic	P.O. & P.S.: Islampur, Murshidabad	U.S.G
51	ERO Emaging Institute (EKO Diagnostic (P) Ltd.)	Berhampore, Murshidabad	Path, X-Ray
52	Farakka Poly Clinic	Farakka, Murshidabad	Path
53	Genebio Diagnostic Center	13, Madhupur Bazar, Berhampore, Murshidabad	Path
54	Health Care & X-Ray Center	Kandi, Murshidabad	Path
55	Hoque Diagnostic Center	Teghori, Murshidabad	Path
56	Indrani Pathology	Opp. Gour Gramin Bank, Gokarna, Murshidabad	Path
57	J. R. X-Ray Clinic	92/7, Pilkhana Road, Ranibagan, Berhampore, Murshidabad	Path
58	Jangipur Medical Center	P.O. & P.S.: Raghunathganj, Murshidabad	Path
59	Jeevan Deep Clinic	Lalbag, Murshidabad	Path
60	Jeevandeep Medical Center	Kandi Hospital Road, P.O. & P.S.: Kandi, Murshidabad	Path
61	Jeevandeep Special Care & Diagnostic Center(P)Ltd.	Vill.: Bhatkuri, P.S.; Berhampore, Murshidabad	Path
62	Jeevanrekha Pathological Laboratory	Vill. & P.O.: P.T. Rosulpur, Domkal, Murshidabad	Path
63	Jiaganj Medical Center	Jiaganj, Murshidabad	Path
64	Jibandeep X-Ray Clinic	190, R.N. Tagore Road, Berhampore, Murshidabad	X-Ray
65	Kandi Medical Center	Dargapara, Hospital Road, Kandi, Murshidabad	Path
66	Kundu Pathological Lab	92/6/1, Pilkhana Road, Ranibagan, Berhampore, Murshidabad	Path
67	Kusum Diagnostic Center	Farakka, Murshidabad	Path
68	Lalbag Medical Center	Golapbagh, Murshidabad	Path
69	Lalbagh X-Ray Clinic	Lalbag, Murshidabad	X-Ray
70	Laldighi Medical Center	7&5/4, R.N.Tagore Road, Berhamore, Murshidabad	Path
71	Life Care Pathological Laboratory	Vill. & P.O.: Islampur, Murshidabad	Path
72	Life Line	37, R. N. Tagore Road, Berhamore, Murshidabad	Path
73	Lions Club of Berhampore (Eye Care Center)	Cantonment Road, Club No.: 630750, P.O.& P.S.: Berhampore,	Eye Care
74	Lisha X-Ray Clinic	3/20/1, K.K. Banerjee Road, P.O. & P.S.: Berhampore,	X-Ray
75	M. Diagnostic Center	College Road, Beldanga, Murshidabad	Path
76	Maa Karunamoyee Imaging Center	Domkal, Murshidabad	X-Ray
77	Matri X-Ray Clinic	Burdwan Hospital Road, Burwan, Murshidabad	Path
78	Medi - lab	Kandi, Murshidabad	Path
79	Medi X-Ray & U.S.G Center	277, Hospital Road, Gopal Bag, P.O.& P.S.: Murshidabad,	X-Ray
80	Medicave Clinic	Raghunathgunj, Murshidabad	Path, X-Ray
81	Medinova	Raghunathgunj, Murshidabad	Path
82	Medirina Diagnostic Center	26/50, Sahid Surya Sen Road, Berhampore, Murshidabad	Path
83	Metro X-Ray Clinic	Gorabazar, Berhampore, Murshidabad	X-Ray
84	Microlab	NTPC More, Murshidabad	Path
85	Micron Diagnostic	R4, 117, R. N. Tagore Road, Berhampore, Murshidabad	Path
86	Mina X-Ray Clinic	Kandi, Murshidabad	X-Ray
87	Monalisa Diagnostic Center	Nabarun, Murshidabad	Path
88	Monalisa X-Ray Clinic	Berhampore, Murshidabad	X-Ray
89	Mondal Ortho Clinic	3/A, Churamani Chowdhury Lane, P.O. & P.S.; Berhampore,	Path
90	Mordern Pathological Lab.	Vill.: Hasrhoria, Palpara, P.O.: Islampore, Murshidabad	Path

LIST OF DIAGNOSTIC CENTRES BY DISTRICT

Sl. No	Name of the Units.	Address	Services Catered
91	Mordern Pathological Laboratory	Nabagram, Murshibad	Path
92	Mordern Pathological Laboratory	Lalbag, Murshidabad	Path
93	Mordern Pathological Laboratory	Bharatpur, Murshidabad	Path
94	Mordern X-Ray Clinic	Barwan, Murshidabad	X-Ray
95	Mordern X-Ray Clinic	Kandi, Murshidabad	X-Ray
96	Mother Diagnostic Center	Raninagar, Murshidabad	Path
97	Mother Land Scan Center	Raghunathgunj, Murshidabad	X-Ray
98	Mukherjee Enterprise	Kandi, Murshidabad	X-Ray
99	Murshidabad Sahid Khudiram Seva Niketan	Khagra, Murshidabad	Path
100	Murshidabad X-Ray Center & Clinic	P.O.: P.T. Rosulpur, P.S.: Domkal, Murshidabad	X-Ray
101	Naba Jeevan X-Ray Center	Domkal Hospital More, Murshidabad	Path
102	Nabagram Diagnostic Center	Nabagram, Murshibad	Path
103	Nagar Medical Center	Vill. & P.O.: Nagar, Murshidabad	Path
104	Narayan Ultrasound Center	Kandi, Bishramtala, Murshidabad	U.S.G
105	New Das Pathological Laboratory	Kandi Hospital Road, Murshidabad	Path
106	New Globe Diagnostic Center	Islampore, Murshidabad	Path
107	New Laxmi X-Ray Clinic	Dehigram, Murshidabad	X-Ray
108	New Medinova Path. Lab.	Nabagram, Murshibad	Path
109	New Suraksha Pathological Laqboratory	Hariharpara (Hospital More), Murshidabad	Path
110	Nightangle X-Ray & Scan Center	77, Vivekananda Road, Golapbagh, Lalbagh, Murshidabad	X-Ray
111	Nimta Clinical Laboratory	Vill. & P.O.: Dofhat (Nimta Rail Gate), P.S.: Suti, Murshidabad	Path
112	Niramoy Clinic	Basudebpur, Chachanda, Murshidabad	Path
113	Nirnoy Patho. Lab.	20/2, Sahid Surya Sen Road, Berhampur	Path
114	Nirnoy Pathological Laboratory	Khargram (Hospital More), Murshidabad	Path
115	Nirnoy X-Ray & Clinic Lab	Basudebpur, Murshidabad	X-Ray
116	Pathology Center	Salar (Bus Stand), Murshidabad	Path
117	Piew Ultrasonography Center	Vill.: Bablabone, P.O.: Rosulpur, P.S.; Domkol, Murshidabad	U.S.G
118	Pratibimba Clinical Laboratory	Vill. & P.O.: Domkal, Murshidabad	Path
119	R. K. U.S.G. Center	Kandi Hospital Road, Murshidabad	U.S.G
120	Remedy Diagnostic Center	Berhampore, Murshidabad	X-Ray
121	Remission Diagnostic Center	45/1, R.N. Tagore Road, Laldighi, Berhampore, Murshidabad	Path
122	Rog Nirnoy	Berhampore, Murshidabad	Path
123	S. Diagnostic Center	Bablabona, Domkal, Murshidabad	Path
124	S. P. Sama Chowdhury X-Ray Clinic	13A/1, R. N. Tagore Road, Berhampore, Murshidabad	X-Ray
125	Sahib Diagnostic Center	Farakka, Murshidabad	Path
126	Salar Medical Center	Salar, Murshidabad	Path
127	Sanjeevani Ultra Sonography Center	Berhampore, Murshidabad	U.S.G
128	Sarkar Pathological Laboratory	Nabarun, Murshibad	Path
129	Sarkar X-Ray Clinic	25, Radhika Mohan Sen Road, Berhampur, Murshidabad	Path
130	Scientific Pathological Laboratory	Kandi Hospital Road, P.O. & P.S.: Kandi, Murshidabad	Path
131	Seba Diagnostic Center	Raghunathgunj, Murshidabad	Path
132	Seba X-Ray Clinic	35, Radhika Mohan Sen Road, P.O. & P.S.: Berhampore,	X-Ray
133	Sengupta X-Ray Clinic	Berhampore, Murshidabad	X-Ray
134	Seva	Begamganj, P.S.: Jiaganj, Murshidabad	Path

LIST OF DIAGNOSTIC CENTRES BY DISTRICT

Sl. No	Name of the Units.	Address	Services Catered
135	Shanti Pathological Clinic	152, Vivekananda Road, Golapbag, Lalbag, Murshidabad	Path
136	Sitaram Health Point	Berhampore, Murshidabad	Path
137	Suraema Pathological Lab	Kandi, Murshidabad	Path
138	Suraksha Diagnostic Center	Jaiganj, Murshidabad	Path
139	Suraksha Imaging Center	70/7, Vivekananda Road, Lalbagh, Murshidabad	Path
140	Suraksha Pathological Laboratory	Berhampore, Murshidabad	Path
141	Suraksha Pathological Laboratory	Beldanga, Murshidabad	Path
142	Sureksha Pathological Laboratory	N. T. P. C. More, Murshidabad	Path
143	Surema Pathological Laboratory	Kandi Hospital Road, Murshidabad	Path
144	Surksha Pathological Laboratory	Kandi, Murshidabad	Path
145	Sushrut X-Ray Clinic	Station Road, Berachampa, Murshidabad	X-Ray
146	Sushrut X-Ray Clinic	Berhampore, Murshidabad	X-Ray
147	Suswastha Pathological Laboratory	Kandi Hospital Road, Murshidabad	Path
148	Swasti Medicare & Diagnostic Center	Barua Rail Bazar, Beldanga, Murshidabad	Path
149	Tithi Diagnostic Center	Raghunathgunj, Murshidabad	Path
150	Ultra Scan	1, Bazar Lane, Berhampore, Murshidabad	U.S.G
151	Urmila Pathological Laboratory	Vill. & P.O.: Panchgram, P.S.: Nabagram, Murshidabad	Path
152	Vinod Pathological Laboratory	Golapbagh, Murshidabad	Path
153	Women's Clinic	92/6/2, Pilkhana Road, Berhampur, Murshidabad	Path
Numbers of Path Lab: 118 ; Blood Bank: 0 ; Dental Clinic: 0 ; Forensic Lab: 0 ; Eye Care: 1			
NADIA			
1	Advance Dignostic & Polyclinic	Kalyani, Nadia	Path
2	Aloka X-Ray Clinic	Dhopwalimore Nabadwip	X-Ray
3	Applo Pathological Laboratory	Santipur, Nadia	Path
4	Appodiagnostic Center	A-9X/6 (CA), Kalyani, Nadia	Path
5	Appolo Diagnostic Center	A-9X/6 (CA), Kalyani, Nadia	X-Ray
6	Arogya (Path. Lab, Chapra Rural Hospital)	Chapra, Nadia	Path
7	Arogya (Path. Lab, Krishnaganj Rural Hospital)	Krishnaganj, Nadia	Path
8	Arogya (Path. Lab.)	Krishnanagar, Nadia	Path
9	Arogya Diagnostic Center	A-9X/3(S), Kalyani	C.T.Scan
10	Astha Lifecare & Diagnostic Hospital	43/6, D.N. Roy Road, Shantipur, Nadia	Path
11	Astha Medical Laboratory	Bethuadahari, Nadia	Path
12	Astha Medicare & Diagnostic Center	43/6, Debandranath Roy Road, Santipur, Nadia	Path
13	Baba Loknath Pathological Lab	Stand Road, Baralghat, Nabadwip, Nadia	Path
14	Baba Loknath X-Ray Clinic	37, D. L. Roay Road, Krishnanagar, Nadia	X-Ray
15	Baba Loknath X-Ray Clinic	Stand Raod, Baralghat, Nabadwip, Nadia	X-Ray
16	Badkulla Diagnostic Clinic	Station Road, Badkulla, Nadia	Path
17	Bagula X-Ray Clinic	College Raod, Hospital More, Bagula, Nadia	X-Ray
18	Belview X-Ray Clinic	Ram Kumar Mitra Lane, Patra Market, Krishnanagar, Nadia	X-Ray
19	Bengal Surgicals Ltd.	Industrial Area, Kalyani, Nadia	Path
20	Bhabani Pathlogy & Diagnostic Center	Nedirpara, Krishnanagar, Nadia	Path
21	Bhabani Pathological Laboratory	Subhash Avenue, Ranaghat, Naida	Path, X-Ray
22	Bhabani X-Ray Clinic	Nabadwip, Nadia	Path
23	Bhowmick Pathological Lab. & Diagnostic Center	P.O.: Karimpur, Nadia	Path

LIST OF DIAGNOSTIC CENTRES BY DISTRICT

Sl. No	Name of the Units.	Address	Services Catered
24	Bikshan Clinical Laboratory	Subhash Avenue, Ranaghat, Nadia	Path
25	Bikshan Pathological Laboratory	Krishnanagar, Nadia	Path
26	Biswas Pathological Laboratory	Maliapara, Krishnanagar, Nadia	Path
27	Biswas Pathology	Vill & P.O. Palashipara, P.S. Tehatta, Dist. Nadia	Pathology
28	Biswas X-Ray Clinic	Chakdaha, Nadia	X-Ray
29	Bose Pathological Center	283, K.B.M, PO. Chakdaha, Dist. Nadia	Path
30	Bose Pathological Clinic	A-9/14(S), Kalyani, Nadia	Path
31	Bose X-Ray	B-7/35(S), Kalyani, Nadia	X-Ray
32	Bose X-Ray & Pathological Clinic	Kalyani, Nadia	Path, X-Ray
33	Bose X-Ray Clinic	A-9/14(S), Kalyani, Nadia	X-Ray
34	Burima X-Ray Clinic	Patra Market, Krishnanagar, Nadia	X-Ray
35	C.B.D.A. Polyclinic & Diagnostic Center	Chakdaha, Nadia	Path
36	Calcutta Diagnostic Center	Sangam Cinema Hall Building, Kalyani, Nadia	Path, X-Ray
37	Calcutta Investigation Center	P.S.: Karimpur, Nadia	Path, X-Ray
38	Calcutta Research & Care Center	Kalyani, Nadia	Path, X-Ray
39	Care & Cure Pathological Center	Gokulpur Bazar, Katagunj, Nadia	Path
40	Carnival Pathological & Diagnostic Diviosion	A-9/16(S), Kalyani, Nadia	Path
41	Central Imaging Center	27, B. L. Chatterjee Road, Krishnanagar, Nadia	X-Ray
42	Central Laboratories	Krishnanagar, Nadia	Path
43	Central Path	77, B.L. Chatterjee Lane, Krishnanagar, Nadia	Path
44	Central X-Ray Clinic	P.O. & Vill.: Debgram, Nadia	X-Ray
45	Chakdah Clinical Laboratory	Ghosh Para, Chakdah, Nadia	Path
46	Chakdaha Clinical Laboratory	Chakdaha, Nadia	Path
47	Chakraborty Pathology	Sangam Cinema Hall Building, Kalyani, Nadia	Path
48	Chandra Diagnostic Clinic	17/1, Dr. K. B. Saha Road, Stragarh, Santipur, Nadia	Path
49	Chandra Diagnostic Clinic	Baigachhi More , Shantipur, Dist. Nadia	Path
50	Chandra X-Ray Clinic	37/1, Ram Kumar Goswami Street, Santipur, Nadia	X-Ray
51	Chandra's Diagnostic Center	86, Rabindra Sarani, Ranaghat, Nadia	Path
52	Charu Ultra Scan & X-Ray Center	N. S. Road, Chakdaha, Nadia	X-Ray
53	City Diagnostic Center	Station Approach Road, Krishnanagar, Nadia	Path
54	Clinic M - X-Ray	5/1, Anantahari Mitra Road, Krishnanagar	X-Ray
55	Clinical Laboratory {Eko Diagnostic (P) Ltd.}	A-9/12, Kalyani, Nadia	Path
56	Clinical Pathological Lab	B - 12/11(S), Kalyani, Nadia	Path
57	Cure Diagnostic Center(Path)	23, Subhas Avenue, Ranaghat, Nadia	Path
58	Cure X-Ray Clinic	Buroshibtala, Nabadwip	X-Ray
59	Curnival X-Ray Scanning Division	A-9/16(S), Kalyani, Nadia	X-Ray
60	Das X-Ray Clinic	Krishnanagar, Nadia	X-Ray
61	Debjani Diagnostic Center	Tehatta, Nadia	Path
62	Debnath Diagnostic Center	D. L. Roy Road, Krishnanagar, Nadia	Path
63	Debnath X-Ray Clinic	26/1, D. L. Roy Road, Krishnanagar, Nadia	X-Ray
64	Deep Diagnostic & Polyclinic	Subarnapur, Haringhata, Nadia	Path, X-Ray
65	Detecta	B 12/23, Kalyani, Nadia	Path
66	Devine Diagnostic Center	Bagula, Nadia	Path
67	Diagnostic & Pathological Center	Saha Bhawan, P.S.: Nabadwip, Nadia	Path

LIST OF DIAGNOSTIC CENTRES BY DISTRICT

Sl. No	Name of the Units.	Address	Services Catered
68	Diagnostic Pathological Clinic	Poramatala Road, Nabadwip, Nadia	Path
69	Disha Pathological Laboratory	Nawadapara, Nadia	Path
70	Doctor's Diagnostic Center	Dey Chowdhury, Super Market, Rathtala, Ranaghat, Nadia	Path
71	Doctors Laboratory	Stand Road, P.O. & Vill.: Palasi, Nadia	Path
72	Dot Diagnostic Center	Nediarpara, Krishnanagar, Nadia	Path, X-Ray
73	Dr. B. B. Majumder Memorial Clinic & Pathology	Bethuadahari, Nadia	Path
74	Dr. B.R. Ambedkar Pathological Lab	Bagula Supermarket, Begula, Nadia	Path
75	Dr. lab	7, Talpukur Road, Krishnanagar, Nadia	Path
76	Dr. Pramanik Health Unit	Tarakabagish lane, Shantipur, Nadia	Path
77	Dr. S. Pramanick Health Care Center	Santipur, Nadia	Path
78	Dutta Pathological Laboratory	P.O.: Karimpur, Nadia	Path
79	Dutta Physiotherapy Center	Taherpur, C-Block, Nadia	Physiotherapy
80	Duttapulia, Diagnostic Clinic	Duttapulia More, Duttapulia, Nadia	Path, X-Ray
81	Dynomic X-Ray Clinic	Chakdaha, Nadia	X-Ray
82	Eko Diagnostic (P) Ltd.	A-1/8(S), Kalyani, Nadia	Path
83	Four Square Chemicals (P) Ltd.	T - 1 / Part (IV), Phase - III, Kalyani, Nadia	Path
84	G. D. Diagnostic	Betai, Tehatta, Nadia	Path
85	Ghosh Diagnostic Center	Fulia Rail Bazar, P.O.: Belermath, Nadia	Path, X-Ray
86	Ghosh Diagnostic Center	Sethigachi, P.O.: Anulia, Ranaghat, Nadia	Path, X-Ray
87	Ghurni Diagnostic	Ghurni, Kotwali, Nadia	Path
88	Gopa Health Analytical	Krishnanagar, Nadia	Path
89	Gopa Memorial Polyclinic & Diagnostic Center	Chakdaha, Lalpur, Nadia	Path
90	Gopal Seba Sadan	34, N.H. Road, Bethuadahari, Nadia	Out Door
91	Haringhata Diagnostic Center	Vill.: Ganguria, P.O.: Subarnapur, Haringhata Bazar	Path
92	Health Care Center, University of Kalyani	Kalyani, Nadia	Path
93	Health Care Diagnostic Center	54(32), Kurchipota Lane, Krishnanagar, P.S.: Kotawali, Naidia	Path
94	Health Care Medical Diagnostic & Engg. Centre,	54 (32), Kurchipota Lane, P.O.: Krishnanagar, Nadia	Path
95	Hrik Diagnostic	14, Ananta Hari Mitra Lane, Krishnanagar, Nadia	X-Ray
96	ILA Diagnostic Center	Rathtala, Ghoshpara Road, Kalyani	Path
97	Inner Eye Endoscopy Imaging Research Center	Nediarpara, Krishnanagar, Nadia	U.S.G
98	Jaguli Pathological Clinic	P.O.: Bara-Gaguli, Haringhata, Nadia	Path, X-Ray
99	Jaguli Polyclinic	Jaguli, Dighapara, Barajaguli, Nadia	X-Ray
100	Jagulia Polyclinic	Jaguli, Nadia	Path
101	Jasoda Clinical Laboratory	Ranaghat, Nadia	Path
102	Jasoda X-Ray Clinic	Anulia, Ranaghat	X-Ray
103	Jaya Diagnostic Center	Karimpur Bus Stand, Nadia	Path
104	Jharna Pathological Lab	Hospital Road, Chapra, Nadia	Path
105	K.P. Diagnostic Pathology	Karimpur Hospital Road, Krishnanagar, Nadia	Path
106	Kalpana Diagnostic Center	Nutanpara, Tehatta, Nadia	X-Ray
107	Kalyani Pathological Clinic	A - 9X / 5(S), Kalyani, Nadia	Path
108	Kalyani Polyclinic	A-9X (CA), Kalyani, Nadia	Path
109	Kalyani X-Ray Clinic	A-1/6(S), Kalyani, Nadia	X-Ray
110	Kamala Polyclinic	Bagula Hospital Road, Bagula	Path
111	Kanailal Pathological Lab	P.O. & Vill.: Karimpur, Nadia	Path

LIST OF DIAGNOSTIC CENTRES BY DISTRICT

Sl. No	Name of the Units.	Address	Services Catered
112	Karimpur Polyclinic	Natidanga More, Karimpur, Nadia	Path
113	Kaya Kalpa Sadan Pathological Laboratory	8/1, Pandit L.K. Mitra Road, Krishnanagore, Nadia	Path
114	Krishna Bhabani X-Ray	Pakatala Road, Nabadwip	X-Ray
115	Krishnanagar Pathological Laboratory	5, R. K. Moitra Lane, Krishnanagar, Nadia	Path
116	Kundu Pathology	45, Kurchipota Lane, Krishnanagar, Nadia	Path
117	Lab Devine	Ranaghat, Nadia	Path
118	Life Line Pathological Lab. & Ultra Scan	271.A2, Subhas Avenue, Ranaghat, Nadia	Path
119	Life Line Pathological Laboratory	P.O. & P.S.: Dhubulia, Nadia	Path
120	Loknath Polyclinic	19, Rabindra Sarani, Ranaghat	Path
121	Loknath Scan Center	103/G, D.L.Roy Road, Deshbandhupally, Krishnanagar	C.T.Scan
122	Loknath X-Ray Clinic	103, D.L.Roy Road, Krishnanagar, Nadia	X-Ray
123	Loknath X-Ray Clinic	Bagula Hanskhali Road, Badkulla, Nadia	X-Ray
124	Lokpati Diagnostic Center	Majdia, Nadia	Path
125	Ma Manasa X-Ray Clinic	Dhubulia Bazar, Nadia	Path
126	Ma Karunamoyee X-Ray Clinic	Karimpur Regulated Market, Karimpur, Nadia	X-Ray
127	Ma Monosha X-Ray Clinic	Dhubulia Natun Bazar, Dhubulia, Nadia	X-Ray
128	Ma Naskar Clinical Lab	Karimpur Regulated Market, Karimpur, Nadia	Path
129	Ma Sabita X-Ray Clinic	17, Pt. Chatterjee Lane, Krishnanagar, Nadia	X-Ray
130	Ma Tara Diagnostic Center	Hanskhali9, Nadia	Path
131	Maa Durga Pathological Laboratory	125, Buroshivtala Road, Nabadwip, Nadia	Path
132	Madanpur Diagnostic Center	Paschimpara, Madanpur, Nadia	Path
133	Madhabi Diagnostic Clinic	Fulia Co-Operative Market P.O.: Fulia, Nadia	Path
134	Mandal Pathological Laboratory	Natunpally, Karimpur, Nadia	Path
135	Mayapur Pathology	Sri Mayapur, Nadia	Path
136	Mayapur Pathology (Mayapur Bikash Sangha)	Mayapur, Nadia	Path
137	Medicare Clinic	Bagan Bari, P.O.: Raghunathgunj, Murshidabad	Path
138	Medicare Diagnostic Center	Kestadanga Bazar, Kestadanga, Nadia	Path
139	Medico X-Ray Clinic	Hazi Md. Ali Market, Bethuadahari, Nadia	X-Ray
140	Mediguard Clinical Lab	Aranghata, Nadia	Path
141	Mediguard Diagnostic Center	Baragaguli, Nadia	Path
142	Mediguard Diagnostic Center	Dighapara, Baragaguli, Nadia	Path
143	Mediguard Pathological Laboratory Center	Subdelpur, Aranghata, Nadia	Path
144	Medilab Clinical Laboratory	60, Dispensary Lane, Ranaghat, Nadia	Path
145	Medipath Pathological Laboratory	Krishnanagar, Nadia	Path
146	Mediview	B-8/7(CA), Kalyani, Nadia	Endoscopy
147	Mediview Diagnostic Services	A-9X/5 (CA), Kalyani, Nadia	Path, X-Ray
148	Mediview Diagnostic Services X-Ray Division	B-8/7C.A., Kalyani, Nadia	X-Ray
149	Mediview M.R. Scan (P) Ltd.	Kalyani, Nadia	X-Ray
150	Mediview MR Scan (P) Ltd.	B-8/7 (CA), Kalyani, Nadia	X-Ray
151	Metali Memorial Polyclinic	Kalyani, Nadia	Path
152	Microscope Diagnostic Center	62/4, Rabindra Sarani, Ranaghat, Nadia	Path
153	Mina Pathological Laboratory	Bangalji, Chapra, Nadia	Path
154	Mitali Memorial Polyclinic	A-9X/5(S), Kalyani, Nadia	X-Ray
155	Mitra Out Door Clinic	Gobindapur Barak, Santipur	Out Door

LIST OF DIAGNOSTIC CENTRES BY DISTRICT

Sl. No	Name of the Units.	Address	Services Catered
156	Mondal Pathological Laboratory	Palashipara, Nadia	Path
157	Mondal Pathological Laboratory	Karimpur, Nadia	Path
158	Monorama Path Lab	Nediarpara, Krishnanagar, Nadia	Path
159	Monorama Pathology	12/1, Subhas Avenue, Ranaghat, Nadia	Path, X-Ray
160	Monorama Ultra Scan (P) Ltd.	Bangaon Road, Chakdaha	U.S.G
161	Monorama Ultra Scan (P) Ltd.	Ranaghat, Nadia	U.S.G
162	Monorama X-Ray Clinic	Bangaon Road, Chakdaha	X-Ray
163	Mordern Diagnostic Center	Station Para, P.O.: Bethuadahari, Nadia	Path
164	Mordern Pathological Center	Hospital Para, Tehatta, Nadia	Path
165	Mordern Pathological Laboratory	Station Para, Bethuadahari, Nadia	Path
166	Mordern Pathological Laboratory	Dhubulia Natun Bazar, Dhhubulia, Nadia	Path
167	Mordern Pathological Laboratory	Hospital Road, Bagula, Nadia	Path
168	Mordern Pathological Laboratory	Hospital Road, Bagula, Nadia	Path
169	Mordern Pathology Center	Tehatta, Nadia	Path
170	Mordern X-Ray Clinic	P.O. Barajaguli, Nadia	X-Ray
171	Mordern X-Ray Clinic	73/1, Subhas Avenue, Ranaghat, Nadia	X-Ray
172	Mother Diagnostic Center	Betai Bazar, P.O.: Betai, P.S.: Tehatta, Nadia	Path
173	Municipal Health Care Center	Raja Road (J.L. Neuuro Road), P.O.: Krishnanagar, Nadia	
174	Naba Suraksha	Tehatta, Nadia	X-Ray
175	Nabadwip Pathological Lab.	Telipara Road, Nabadwip, Nadia	Path, X-Ray
176	Nadia Clinical laboratory	Pritinagar, Nadia	Path
177	Nadia Medical Center	Nediarpara, Krishnanagar, Nadia	Path
178	Neuro Diag. Clinic	A-9X/5(S), Kalyani, Nadia	E.E.G
179	New Charu X-Ray	Chakdaha, Nadia	X-Ray
180	New Life Medical Center	RBC Road, Chakdaha, Nadia	Path, X-Ray
181	New Medicate Diagnostic Center	B-7/13 (S), Center park, Kalyani, Nadia	Path
182	New Tropical Pathology	J.N. Roy Bahadur Road, Malipara, Krishnanagar, Nadia	Path
183	Niramoy U.S.G. Center	Baralghat, Nadia	U.S.G
184	Niranjana Pathological Laboratory	Station Road, Fuba Nadia	Path
185	Nirikshan	1, Vivekananda Sarani, Ranaghat, Nadia	Path
186	Nirikshan Pathological Laboratory	13/1, Ananta Hari Mitra Road, Krishnagar, Nadia	Path
187	Nirnayan Patho Lab.	Fulia, Nadia	Path
188	Nirnoy Pathological Lab. (I.M.A.)	Krishnagar, Nadia	Path
189	Nirnoy Pathology	I.M.A.Bhawan, Church Road, Krishnanagar, Nadia	Path
190	Nirupan Diagnostic & Research Center (P) Ltd.	A-9X/4(CA), Kalyani	X-Ray
191	Nirupan Diagnostic & Research Ins. (P) Ltd.	A-9X (CA), Kalyani, Nadia	Path
192	Nirupan Diagnostic Center	A - 8/157 Kalyani, Nadia	Path
193	Nirupan Laboratory	13, Bejikhali Road, Krishnanagar, Nadia	Path
194	Nirupan Polyclinic & Diagnosticc (P) Ltd.	A-8/157, Kalyani, Nadia	X-Ray
195	Organ Daignostic Poly Clinic	Badkulla, Nadia	Path
196	Orthocare	Mahabir Super Market, 84, Subhas Avn. Ranaghat	Physiotherapy
197	P.M.B.R. Reaserch Lab	Station Para, Badkulla, Nadia	Path
198	Paltu Guha X-Ray Clinic	Dhubulia Bazar, Nadia	X-Ray
199	Pathocare	Santipur, Nadia	Path

LIST OF DIAGNOSTIC CENTRES BY DISTRICT

Sl. No	Name of the Units.	Address	Services Catered
200	Pathological Laboratory	B - 8/7 (C.A.), Kalyani, Nadia	Path
201	Pathological Laboratory	Debgram (Bus Stand), Nadia	Path
202	Pathololab	1No. D.L. Roy Road, 1st floor of usha Pharmacy, Krishnagar, Nadia	Path
203	Paul Diagnostic Polyclinic	Santipur, Nadia	Path
204	Perfect Diagnostic Center	Ranaghat, Nadia	Path
205	Phisiotherapy Center	P.B. Bhatteejee Road, Krishnanagar	Physiotherapy
206	Phisiotherapy Establishment	Mahabir Super Market, 84, Subhas Avn. Ranaghat	Physiotherapy
207	Prabha Pathology	Nowapara, P.O.: Tehatta, Nadia	Path
208	Pragati Netralaya	Debendrapally, Chakdah, Nadia	Path
209	Pramanik Health Unit	18, Tarak Bagish Lane, Santipur, Nadia	X-Ray
210	Pranabananda Pathological Laboratory	Payradanga, Nadia	Path
211	Prapti Pathological Clinic	A-8/24, Kalyani Nadia	Path
212	Pratibimba Pathological Laboratory	37, Subhas Avenue, Ranaghat, Nadia	Path
213	Pritha Pathological Laboratory	Cinema House Lane, Krishnanagar, Nadia	Path
214	R. K. Clinical Laboratory	Bhatjangla, Nadia	Path
215	Radha Clinical Laboratory	Pritinagar, Nadia	Path
216	Ranaghat Clinical Lab	66/1, Rabindra Sarani (North), Ranaghat, Nadia	Path
217	Ranaghat Lions Disalima Diagnostic Center	33/1, Biswaspara Lane, Ranaghat, Nadia	Path
218	Ranaghat Lions Eye & General Care Center	33/1, Biswaspara Lane, Ranaghat, Nadia	Eye Care
219	Ratan X-Ray Clinic	Nonagunj More, Bagula	X-Ray
220	Reliable Diagnostic Center	A-9/12(S), Kalyani, Nadia	Path, X-Ray
221	Relife Diagnostic & Polyclinic	Bethuadahari, Nadia	Path
222	Re-Life Diagnostic Center & Polyclinic	Hospital Road, Bethuadahari, Nadia	X-Ray
223	Remedy Diagnostic Clinic	34, Subhas Avenue, Ranaghat, Nadia	Path
224	Renuka Diag. (P) Ltd.	9, Cinema House Lane, Krishnanagar	C.T.Scan
225	Rishar Dental Lab. & Res. Center	Sarkar Para, Ranaghat	Dental Withchair
226	Rupayan Diagnostic Lab	Purbanagar, Madanpur, Nadia	Path
227	Sanjiboni Diagnostic Center	Pritinagar, Payradanga, Nadia	Path
228	Santipur New X-Ray	Arannya Market, Santipur Railbazar, Santipur	X-Ray
229	Santipur New X-Ray	1, R. N. Tagore Road, Rail Bazar, Santipur	X-Ray
230	Saraswati Diagnostic Center	Krishnaganj, Nadia	Path
231	Satima X-Ray Clinic	Ghoshpara, Nadia	X-Ray
232	Seba Poly Clinic	6, Subhas Avn. Ranaghat	Path
233	Seba X-Ray Clinic	College Raod, Karimpur, Nadia	X-Ray
234	Sebayan Pathology Center	Tehatta, Nadia	Path
235	Sebayan Policlinic Dignostics & Path	A-9X/12, Kalyani, Naida	Path
236	Serum Pathology Center	S. R. Sen Road, Nazirpara Krishnanagar, Nadia	Path
237	Sevayan Pathological Clinic	Ram Sita Para, Nabadwip, Nadia	Path
238	Shivam Pathological Laboratory	Nabadwip, Nadia	Path
239	Shushrusha Clinical & Diagnostic Center	Tehatta, Nadia	Path
240	Simatory Laboratory	1/1, M.M. Ghosh Street, Krishnagar, Nadia	Path
241	Singha Pathological Laboratory	Debogram, Nadia	Path
242	Site X-Ray Clinic	Talpokur Road, Krishnanagar	X-Ray
243	Sri Arabindo Doctor's Chamber	Lalpur Bangaon Road, Chakdaha	Path

LIST OF DIAGNOSTIC CENTRES BY DISTRICT

Sl. No	Name of the Units.	Address	Services Catered
244	Sri Guru Sangha Chikitsalaya	Ranir Chara, Sreegurusangha, Nabadwip, Dist. Nadia	Clinic
245	Suraksha Diagnostic	B16/8 (S), P.O. & P.S.: Kalyani, Nadia	Path
246	Suraksha Diagnostic Center	Vill. & P.O.: Tehatta, Nadia	Path
247	Sushila X-Ray Clinic	5/4, D.L.Roy Road, Krishnanagar	X-Ray
248	Sushrusa Pathology	Tehatta (Near Hospital), Nadia	Path, X-Ray
249	Swaraswati Diagnostic Center	Krishnanagar, Nadia	Path
250	Swasti Diagnostic Center	Santipur, Nadia	Path
251	Swasti Polyclinic & Diagnostic Center	Chakdaha, Nadia	Path
252	Tanisha Pathological Lab & X -Ray	Bagula, Nadia	Path, X-Ray
253	Tarama X-Ray Clinic	Ashwini Kr. Dutta Lane, Krishnanagar	X-Ray
254	The Scientific Laboratory	Bara-Gaguli, Nadia	Path
255	Ultrasonography	I.M.A.Bhawan, Church Road, Krishnanagar, Nadia	U.S.G
256	United Pathological Center	20, R.N. Tagore Road, Krishnanagar, Nadia	Path
257	United X-Ray Center	Krishnanagar, Nadia	X-Ray
258	Ureka Investigation Center	30/B, Siddewsaritala by Lane, Ranaghat, Nadia	Path
259	Usha Diagnostic Pathology	28, Subhas Avenue, Ranaghat	Path, X-Ray
260	Usha Gram Trust	Birnagar, Nadia	Path
261	Usha Pathological Clinic	Bagula Hospital Road, Bagula	Path
262	Usha X-Ray & Diagnostic Clinic	Kritinagar Colony, Ranaghat	X-Ray
263	Usha X-Ray Clinic	D.L.Roy Road, Krishnanagar	X-Ray
264	X-Ray Division	1 No. Nediapara Road, Krishnanagar, Nadia	X-Ray
265	Spandan Diagnostic Centre	Rathadanga Road, Rathtala, Ranaghat, Dist. Nadia	Path
266	Shri Chaitanya Health Care	Gour Nitai Bhaban, Gouranga, Mayapur, Dist. Nadia	Clinic
Numbers of Path Lab: 186 ; Blood Bank: 0 ; Dental Clinic: 0 ; Forensic Lab: 0 ;			
NORTH 24 PARGANAS			
1	Abiskar Laboratory	Vill-No. 1, Dighirpar, P.O. & P.S. Canning, Dist. South 24 Parganas	Path
2	Accure Diagnostic Center	21, B. T. Road, Rabindra Bhawan, Khardah, North 24 Pgs	Path
3	Accurex Diagnostic Center	Nimta Plaza, Sarkarhat, P.O.:Nilgunj Bazar, North 24 Parganas	Path
4	Agarpara X-Ray Clinic & Laboratory	Agarpara, North 24 Pgs	Path, X-Ray
5	Al Mustafa Hospital X-Ray Clinic	Mandra, North 24 Pgs	Path, X-Ray
6	All India Institute of Medical Technologists	CD-84, Salt Lake City, Sector - I,	Training Institute
7	Anadaloke Medical centre Pvt. Ltd.	3/3, Hill Cart Road, Near Mahendra Bridge, P.O. & P.S. Siliguri, Dist. Darjeeling	Clinic
8	Ankur Diagnostics	R.N. Avenue, Sodepur, North 24 Pgs	Path
9	Anandamath Diagnostic Centre	204, Anandamath, PO. Ichapore, Dist. 24 Pgs (N)	Path
10	Annapurna Diagnostic Center	Madhyamgram, North 24 Pgs	Path
11	Anubhab Diagnostic Center	71/1, Feeder Road, Belghoria, Kolkata - 700 056	Path
12	Anushandhan Pathological Lab.olab	Station Road, Kalitala, Gobardanga, North 24 Pgs	Path
13	Appolo Daignostic	Feeder Road, Belghoria, Kolkata - 56	Path
14	Archana Diagnostic Center	Kanchrapara, North 24 Pgs	Path
15	Arena X-Ray & Pathological Lab.ological Center	Arena Market, P.O. & P.S.: Habra, North 24 Parganas	Path
16	Arogya Diagnostic Center	Ashokenagar-Kalyangarh Municipality, North 24 Parganas	Path
17	Arogya U.S.G. with X-Ray	Ashoknagar, North 24 Pgs	X-Ray

LIST OF DIAGNOSTIC CENTRES BY DISTRICT

Sl. No	Name of the Units.	Address	Services Catered
18	Ashima Clinical Laboratory & Polyclinic	49/1, Sukanta Sarani, Kolkata - 79	Path
19	Athpur Clinical Pathological Lab.ological Laboratory	Athpur, North 24 Pgs	Path
20	ATS Diagnostic	156 / B /3 /C /1, B. T. Road, (Baranagar), Kolkata - 35	Path
21	Authentic Diagnostic Center	Masalandapur, Habra, North 24 Pgs	Path
22	Bactro Clinical Lab	School Road Bongaon	Path
23	Badartala X-Ray Clinic	Naihati, Basirhat, North 24 Pgs	X-Ray
24	Badu Community Welfare & Diagnostic Cente	Badu, North 24 Parganas	Path
25	Bagdah Pathological Lab.ological Clinical Laboratory	Bagdah, North 24 Pgs	Path
26	Bagmore Diagnostic Center	Kanchrapara, North 24 Pgs	Path
27	Bangaon Diagnostic Clinic	Court Road, Bongaon	Path
28	Barrackpore Bactroclinical Laboratory	2, B. T. Road, Talpukur, North 24 Pgs	Path
29	Barrackpore Medicare & Recovery Center Ltd.	6/6, B.T. Road, Talpukur, North24 Parganas	Path
30	Basirhat Scientific Pathological Lab.olab	Basirhat, North 24 Pgs	Path
31	Basirhat X-Ray Clinic	Basirhat New Market, North 24 Pgs	X-Ray
32	Beekshyan Clinical Laboratory	Madhyamgram, North 24 Pgs	Path
33	Belghoria X-Ray Clinic & Diagnostic	Belghoria, Kolkata - 700 056	Path
34	Berachampa X-Ray Clinic	Berachampa, Debalaya, North 24 Pgs.	X-Ray
35	Bethune Pathological Lab.ological Laboratory	44, Central Road, Anandapuri Barrackpore, North 24 Pgs	Path
36	Bharat Clinical laboratory	Chakdah Road, Bongaon, North 24 Pgs	Path
37	Bharat Pathological Lab.ological Laboratory	Badartola, Basirhat, North 24 Pgs	Path
38	Bioanalyst	P-770, Block - A, Lake Town, Kol - 89	Path
39	Bishnu Priya Poly Clinic Diagnostic	9, Jessore Road, Banamalipur (West), Barasat, North 24 PGS	Path
40	Bishnu X-Ray Clinic	Court Road, P.O. & P.S.: Bongaon, North 24 Parganas	X-Ray
41	Biswas Pathological Lab.ological Laboratory	Basirhat, North 24 Pgs	Path
42	Blood Diagnostic Centre	Naihati, Badartala, Basirhat, North 24 Parganas	Path
43	Bongaon Diagnostic Clinic	Bongaon, North 24 Pgs	Path
44	Care Pathological Lab.ology	Court Road, Bongaon	Path
45	Care X-Ray & Investigation Center	Kankinara Bazar, North 24 Pgs	Path, X-Ray
46	Central Clinical Lab.	Bichalighata, Bongaon	Path
47	Central Diagnostic Center	4/2, S,N. Banerjee Road, Champa Cinema Building,Barrackpore,	Path
48	Chakraborty Pathological Lab.ological Lab	Ganapatipur, Basirhat, North 24 Pgs	Path
49	Chakraborty Pathological Lab.ology Center	Naihati, North 24 Pgs	Path
50	Chakraborty Polyclinic & Diagnostic Center	Taki Road, Champadali More, Barasat, North 24 Pgs	Path
51	Chandpara Medical Center	Chandpara Bazar, Bongaon	Path
52	Charitable Dispensary & Diagnostic Clinic	Ramkrishna Math, Barasat, North 24 Pgs	Path
53	Charu Dental Clinic	Amrabati, Sodepur, North 24 Pgs	Dental
54	Chowdhury Pathological Lab.ological Laboratory	Masalandapur, Habra, North 24 Pgs	Path
55	Clinical Investigation Center	276, Sarat Chatterjee Road, P.O. New Barrackpore,North 24 Pgs	Path
56	Cossipore Society of Health Care & Research	68/5, Neogi Para Road, P.O. & P.S.: Baranagar, North 24 Pgs	Path
57	D.I.C. Ultrascan & Imaging	Belghoria, Kolkata - 700 056	Path
58	D.S. Diagnostic Center	8/1, Tagore Temple Road, Shyamnagar, North 24 Pgs.	Path
59	Dakshinaswar Clinical Laboratory	Dakshineswar, Kolkata - 76	Path
60	Day Night Polyclinic	Shyamnagar, 24 Pgs (N)	Path
61	Deb Dental Clinic	Central Road, Barrackpore, North 24 Parganas	Dental

LIST OF DIAGNOSTIC CENTRES BY DISTRICT

Sl. No	Name of the Units.	Address	Services Catered
62	Debolina Diagnostic Service	Basirhat, North 24 Pgs	Path
63	Dental Clinic	39, Work Shop Road, Kanchrapara, North 24 Parganas	Dental
64	Deshapriya Clinic	Hasnabad, North 24 Pgs	X-Ray
65	Deshpran Pathological Lab.ology Clinic	Swarupnagar, North 24 Pgs	Path
66	Dew Drop Diagnostic	Bagiola, P.O.: Kolsur, P.S.: Bagdah, North 24 Parganas	Path
67	Dhriti Shree Polyclinic	Habra, North 24 Pgs	Path
68	Dhrubak Diagnostic Center	5 No. B. T. Road, Panihati, 24 Pgs (N)	Path
69	Dia Pathological Lab. Clinic	Bira Station Road, North 24 Parganas	Path
70	Diag Point	K. D. Complex, 1st Floor, 364 Basudevpur Road, Shyamnagar,	Path
71	Diagard (P) Ltd.	102, Feeder Road, Belghoria, Kolkata - 700 056	X-Ray
72	Diagnostic Interpretation Center	Belghoria, Kolkata - 700 056	Path
73	Diagnostic Laboratory	Chiriamore, Barrackpore, North 24 Pgs	Path
74	Diagnostic Laboratory & Chest Clinic	Barasat, North 24 Pgs	Path
75	Diagnostic Pathological Lab.ological Laboratory	Ashoknagar, North 24 Pgs	Path
76	Diagnostic X-Ray & Investigator Center	2, Jan Md. Ghat Road, Naihati, North 24 Parganas	Path
77	Dipseva Polyclinic	Patulia, North 24 Pgs	Path
78	Dishari Diagnostic Pathological Lab. Lab.	Ashoknagar, North 24 Pgs	Path
79	Doctor's Clinical Lab	Basirhat, North 24 Pgs	Path
80	Dolphin Health Home	Habra, North 24 Pgs	Path
81	Dolphin Medical Clinic	Ashoknagar, North 24 Pgs	Path
82	Downview Pathological Lab.ological Center	Hasnabad, North 24 Pgs	Path
83	Dr. A. K. Amanul Haque (U.S. Centre)	7/3, Nilganj Road, P.O.: & P.S.: Belghoria, North 24n parganas	U.S.G
84	Dr. B. R. Ambedkar Diagnostic Center	Raigachi, Battala, Rajarhat Road, North 24 Pgs.	Path
85	Dream Land Diagnostic	Chakdaha Road, Bangaon	U.S.G
86	Dum Dum Medical Center	3A, Pollock Avenue, Kol - 80	Path
87	Dutta & Chowdhury Pathological Lab.ological Lab.	Halisahar Station Road,P.O.Nabanagar,P.S. Bizpur,North 24 Pgs	Path
88	Dutta Pathological Lab.ological Lab. & X-Ray Center	A. B. Road, Fingapara, North 24 Pgs.	Path, X-Ray
89	Eastend Pathological Lab. Lab & Res. Center	38, Jessore Road, Champadali, Barasat, North 24 Pgs	Path
90	Eastern Clinical Lab.	Patpatti, Kalibari Road, Habra, North 24 Pgs.	Path
91	Eastern Medical Clinic	BF-36, Salt Lake City, Kolkata - 64	Path
92	E-Pathological Lab. Laboratory	Ichapur, North 24 Pgs	Path
93	Eureka Clinical Laboratory	Mondalpara, Gaighata, North 24 Pgs	Path
94	G. Genesis Diagnostics Center,	228, East Ghosh Para Road, Shyamnagar, North 24 Parganas	Path
95	G. L. Polyclinic & Diagnostic Laboratory	Prosadnagar, Kolkata - 58	Path
96	G.S. Laboratory	Taki Road, Deganga, North 24 Pgs.	Path
97	Gan Laboratory	Jessore Road, Habra, North 24 (N)	Path
98	Garulia Pathological Lab.olab	Garulia, 24 Pgs (N)	Path
99	Genesis Diagnostic Center	Shyamnagar, 24 Pgs (N)	Path
100	Godwin Care Clinic	School Road, Sodepur, North 24 pgs	X-Ray
101	Golden Medicare & Diagnostic Center	6,Bijoynagar,AdtaraRoad,Deulpara,P.O.&P.S.Naihati,North24Pgs	Path
102	Goodwill X-RY & Diagnostic Center	Sodepur, North 24 Pgs.	Path, X-Ray
103	Gram Seva Sangha	Habra, North 24 Pgs	Path
104	Great X-Ray Clinic	Haroa, North 24 Pgs	X-Ray

LIST OF DIAGNOSTIC CENTRES BY DISTRICT

Sl. No	Name of the Units.	Address	Services Catered
105	Green View Diagnostic Center	B. T. Road, Dhankal, Panihati, North 24 Parganas	Path
106	H. B. Polyclinic & Diagnostic Center	Chandpara, Gaighata, 24 Pgs (N)	Path
107	Halder Diagnostic Center	Patulia, North 24 Pgs	Path
108	Heal Diagnostics (P) Ltd.	6/1, Nager Bazar Road, Dum Dum, North 24 Pgs.	Path
109	Health Suraksha Pathological Lab. Diagnostic Center	Kharibarti, Barasat, North 24 Pgs	Path
110	Heathcare Center	6, K. N. C. Road, Barasat, North 24 Parganas	Path
111	Hope Clinic	EB-26 / A, Baguihati Road, Baguihati Bazar, North 24 Pgs.	Path
112	Hormone Diagnostic & Res. Lab. Pvt. Ltd.	HB - 36 / A / B, Salt Lake SEC - III, Kol - 97	
113	Hridaypur Diagnostic Center	Hridaypur, Barasat, Noth 24 Pgs	Path
114	Ichamati X-Ray Lab	Hasnabad, North 24 Pgs	Path, X-Ray
115	Ideal Clinical Laboratory	Ichapur, North 24 Pgs	Path
116	Ideal Pathological Lab.ological Lab.	Helancha Super Market, Helancha Colony, North 24 Pgs	Path
117	Ideal Pathological Lab.ological Laboratory.	Barasat, North 24 Pgs	Path
118	Ila Polyclinic & Diagnostic Center	Kanchrapara, North 24 Pgs	Path
119	Inner Health Diagnostic Center	B/1/2, Purbayan, Sodepur, North 24 Pgs	Path
120	Innova Diagnostic Center	Barasat, North 24 Pgs	Path
121	Institute of Reproductive Medicine	HB-36 / A / 3, Sec - III, Salt Lake, Kol - 106	Path
122	Iris Eye Day Care Center	C-25A/(11/A/1) C-Road, Anandapur, Barrackpore, North 24 Pgs	Path
123	J.S. Diagnostics	105/56, Dum Dum Road (Sil Bagan), Kolkata - 74	Path
124	Jasoda Clinical Laboratory	Ranaghat, Nadia	Path
125	Jeevan Joyti Eye Care & Microsurgery Clinic	107, Feeder Road, Belgharia, Kolkata - 56, North 24 Pgs.	Path
126	Jeevan Sikha Physiotherapy & Polyclinc	Sodepur, North 24 Pgs.	Path
127	Jeevan Suraksha diagnostic Center	Jessore Road, Habra, North 24 (N)	Path
128	Jibandeeep Speialist Clinic & Day Care Center	61/169, Surya Sen (4) Station Road, Khardah, North 24 Pgs.	Path
129	Jibondeep Diagnostic Center	P.O. & Vill.: Sewli Telwenipara, Barasat Road, North 24 Pgs	Path
130	Joyti Clinical Lab	Court Road, Bongaon	Path
131	Joyti Dental Clinic	11, Lenin Sarani(1st Floor),Room No.06,Kanchrapara,North 24Pgs	Dental
132	Jyoti Diagnostic Center	Chandpara, Gaighata, 24 Pgs (N)	Path
133	Kalpataru Arogyiniketan O Gobeshana Unit (Pathology)	Barasat, North 24 Pgs	Path
134	Kalpataru Arogyiniketan O Gobeshana Unit (Radiology)	Barasat, North 24 Pgs	Radiology
135	Kalpana X -Ray	273, Post Office Road, PO. & PS. Habra, Dist. North 24 Pgs.	X-Ray
136	Kamala Diagnostic Cente	Itenda Road, Basirhat, North 24 Pgs	Path
137	Kancharapara Polyclinic	Kanchrapara, North 24 Pgs	Path
138	Khardah X-Ray Clinic	B.T. Road, Khardah, North 24 Pgs	X-Ray
139	Labanhrad Diagnostic Center	1B, 175, Sector - III, Salt Lake, Kol - 74	Path
140	Lab-O-Aid Polyclinic & Eye Microsurgery Unit	13, T.N. Biswas Road, P.O.: Alambazar, P.S.: Belghoria, Kolkata - 25	Path
141	Life Cure Diagnostic Laboratory	Basirhat, North 24 Pgs	Path
142	Life Diagnostic Center	Vill & P.O. & P.S.: Habra, North 24 Parganas	Path
143	Life Line Laboratory	Barasat, North 24 Pgs	Path
144	Life Line Polyclinic	6/4N.C. Mitra Road, Dum Dum Cantonment, Kol - 28	Path
145	Life X-Ray & Diagnostic Center	Hisabi, Amdanaga, North 24 Pgs	Path, X-Ray
146	Lifeline Diagnostic Center	378/3, Ashoknagar, North 24 Pgs	Path
147	Livizi Diagnostic Center	Ariadaha, Kolkata - 700 057	Path
148	Loknath X-Ray & Diagnostic Clinic	Barasat, North 24 Pgs	Path, X-Ray

LIST OF DIAGNOSTIC CENTRES BY DISTRICT

Sl. No	Name of the Units.	Address	Services Catered
149	Luner Diagnostic Clinic	D.D.M Ghat Road, Kolkata, North 24 Pgs	Path
150	M. B. Diagnostic Center	AC - 40, Prafulla Kanan, P.S.: Rajarhat, Kestopur, North 24 Pgs	Path
151	M. P. Diagnostic & Polyclinic	Station Road, P.O. & P.S.: Barasat, Kolkata - 124, North 24 Pgs	Path
152	Maa Annapurna Diagnostic Center	Madhyagram, North 24 Parganas	Path
153	Maa Clinical Laboratory	Gangrapota, Bongaon, North 24 Pgs	Path
154	Maa Diagnostic & Polyclinic	H. B. Town, Road No - 4 Sodepur, Kolkata - 700110	Path
155	Maa Investigation Center	66/1/1, Swami Vivekananda Road, Nibedita Place, Barasat, North 24	Path
156	Made in India Pariwar Welfare & Awareness Society	Barrackpore, North 24 Pgs	Path
157	Madhab Medical Complex	Chakdaha Road, Bongaon	Path, X-Ray
158	Madhyamgram Diagnostic & Infertility Center	Madhyamgram, Sodepur Road, North 24 Parganas	Path
159	Main X-Ray Clinic	Itenda Road, Basirhat, North 24 Pgs	X-Ray
160	Majumder X-Ray Clinic	Barasat, North 24 Pgs	X-Ray
161	Manisha Laboratory	Barasat, North 24 Pgs	Path
162	Manoj Modi Foundation Dialysis Center	Kalyannagar, Rahara, North 24 Pgs.	Path
163	Medi Diagnostics & Poly Clinic	A/71, H.B. Town, Road No-4, Meheta Apartment, Sodepur, North 24	Path
164	Medi Need	157/2A, Gopal Lal Thakur Road, Dunlop More, North 24 Parganas	Path
165	Medi Scan	Shyamnagar, 24 Pgs (N)	Path, X-Ray
166	Medical Investigation Center (Adhikary X-Ray Clinic)	16, Ghosh Para Road, Bhatpara, North 24 Pgs	X-Ray
167	Medicare	63, Lenin Sarani, Kanchrapara, North 24 Pgs.	Path
168	Medicare Diagnostic Center	Rudrapur, Baduria, North 24 Pgs	Path
169	Medicare Diagnostic Center (P) Ltd.	Barasat Road, Barrackpore	Path
170	Medicare Laboratory	Station Road, Guma, North 24 Pgs	Path
171	Medicate Diagnostic Center	Halisahar, North 24 Pgs	Path
172	Medicave Diagnostic Center	Hisabi, Amdnaga, North 24 Pgs	Path
173	Medicave Diagnostic Center (P) Ltd.	12 No. Rail Gate, Noapara, Barasat, North 24 Parganas	Path
174	Medicave Diagnostic Center (P) Ltd.	Titagarh, North 24 Pgs	Path
175	Medicave Medical System (P) Ltd.	8(4/D), Barasat Road, Nonachandanpukur, Barrackpore, North 24 Pgs	Path
176	Medifield Polyclinic	Abdulbari Road, P.O.: Madhyamgram Bazar, North 24 Pgs.	Path
177	Medifield Diagnostic Centre	22, Feeder Road, Belgharia, Kolkata- 700056	Path
178	Medilab Diagnostic Center	Belghoria, Kolkata - 700 056	Path
179	Mediland	Sukchar, Kolkata - 700 115.	Path, X-Ray
180	Mediland Diagnostic Services	23/20/17, Dr. N.C. Bose Road, Belidaghata Main Road, North 24 Pgs	Path
181	Mediscan	P - 30, L. I. C. Park, P.O.: Sodepur, North 24 Pgs.	X-Ray
182	Mediview Diagnostic Center	Madhyamgram, North 24 Pgs	Path
183	Medland Diagnostic Center	Halisahar, North 24 Pgs	Path
184	Medlife Pathological Laboratory	Haroa, North 24 Pgs	Path
185	Meena Diagnostic Laboratory	107, K.G.R. Pathological Lab. (S), Kanchrapara, North 24 Pgs	Path
186	Megha Diagnostic Center	Naihati, Badartala, Basirhat, North 24 Parganas	Path
187	Memorial X-Ray & ECG Clinical Laboratory	Raigachi Ghat, P.O.: Rajarhat, North 24 Pgs.	Path
188	Micro Lab	Kazipara, Barasat, North 24 Pgs	Path
189	Micro Diagnostic Centre	Santoshpur More, Vill. & PO. Mirhati, PS. Amdanga, North 24 Pgs	Path
190	Microbe & Health Diagnostic Center Mukti Polyclinic	Deulpara, Naihati, North 24 Pgs	Path
191	Midas Touch Health Care (P) Ltd.	862, Jessore Road (EMC Factory), Kol - 55, North 24 Pgs.	Path
192	Midland Diagnostic Center (P) Ltd.	34 Anupama Road, Kol - 56	Path

LIST OF DIAGNOSTIC CENTRES BY DISTRICT

Sl. No	Name of the Units.	Address	Services Catered
193	Millenium Health Care	AC-203, Prafulla Kanan, Kestopur, Kolkata - 101	Path
194	Millennium Diagnostic & Research Center	Barasat, North 24 Pgs	Path
195	Mita Clinical Laboratory	Bangoan, North 24 Pgs	Path
196	Mondal Enterprise	Basirhat, North 24 Pgs	U.S.G
197	Monobikash Kendra	54/A/1, Kalibari Road, North 24 Parganas	Path
198	Mordern Medico Pathological Lab.ological Center	Haroa, North 24 Pgs	Path
199	Mordern Pathological Lab.ological Center	Basirhat Munsef Para, North 24 Pgs	X-Ray
200	Mordern View Medical Diagnostic Center	Habra, North 24 Pgs	Path
201	Mordern X-Ray Clinic	Basirhat, North 24 Pgs	X-Ray
202	Mukherjee Clinic & Laboratory	43/C/5, Jatindra Sarni, Jessore (North), P.O.: Barasat, North 24	Path
203	N. B. Clinical Laboratory	New Barrackpore, North 24 Pgs	Path
204	Naihati Medical Center	Naihati, North 24 Pgs	Path
205	Naihati Pathological Lab.ological Centre	36, R.B.C. Road, PO. & PS. Naihati, Dist. North 24 Pgs	Path
206	Nirmayon Clinical Laboratory	Ukilpara,	Path
207	Nanritam for Swami Lokeshwarananda Seva Kendra	87, Netaji Colony (B.T. Road), Kol - 90	Path
208	Neha Eye Center (P) Ltd.	M.J. Apartment (1st Floor), P.O.: B.K.P., P.S.: Titagarh, North 24	Eye Care
209	Neo Diagnostic Center	Flat - No.A/2, Golders Green Complex. 1, Kaikhali, Kolkata - 52	Path
210	New Anandolok Polyclinic & Investigation Center	Basirhat, North 24 Pgs	Path
211	New Anusandan Pathological Lab.ological Laboratory	Gobardanga, Kalatala, North 24 Pgs	Path
212	New Habra Nursing Home (Eye Care)	Hijalpukuria, Habra. North 24 Pgs	Eye Care
213	New Life Diagnostic Center	Baguihati, Rajarhat Road, Sahabagan, Jangra, North 24 Parganas	Path
214	New Life Pathological Lab.ological Center	Badartola, Basirhat, North 24 Pgs	Path
215	New Naihati X-Ray Clinic	232/3, R.B.C. Road, Naihati, North 24 Parganas	X-Ray
216	New Pathological Lab.ological Lab	Itenda Road, Basirhat, North 24 Pgs	Path
217	New Sun Diagnostic Laboratory	Belghoria, Kolkata - 700 056	Path
218	New Suraksha	Jamrultala, Basirhat, north 24 Pgs	Path
219	New Suraksha Pathological Lab.ological Laboratory	Basirhat, North 24 Pgs	Path
220	New Suswastha Diagnostic	Uttar Habra, North 24 Pgs	Path
221	New Trisha Diagnostic Center	Mondal Para, P.S.: Gaighata, North 24 Parganas	Path
222	New X-Ray Clinic	Basirhat, North 24 Pgs	X-Ray
223	New X-Ray Clinic	Rathtola, berachampa, North 24 Pgs	X-Ray
224	Nibar Pathological Lab.ological Laboratory	Garulia, 24 Pgs (N)	Path
225	Niramoy Pathological Lab.ological Lab	Hasnabad, North 24 Pgs	Path
226	Niramoyee Pathological Lab.ological Laboratory	Sodepur, North 24 Pgs.	Path
227	Niranjana Clinical Lab	Natunbazar, Basirhat, North 24 Pgs	Path
228	Nirikshan Clinical Laboratory	Badaretola, Basirhat, North 24 Pgs	X-Ray
229	Niriksha Diagnostic Centre	Barasat Road, Sodepur, Dist. North 24 Parganas	Path
230	Nirmayon Clinical Laboratory	Basirhat, North 24 Pgs	Path
231	Nirnoy	Belghoria, Kolkata - 700 056	Path
232	Nirnoy Pathological Lab.ological Clinical Lab.	B.M. Banerjee Road, Belghoria, Kolkata - 700 056.	Path
233	Nirupan	Rabindra Avn. Opp - Rabindra Cinema, Sodepur, North 24 Pgs.	Path
234	Nishidin Diagnostic Center	144/1, Central Road, Anandapuri, Barrackpore, North 24 Pgs	Path
235	North Dum Dum Development Corporation	1, Nabanagar Road, Birati, Kolkata - 700 061.	Path

LIST OF DIAGNOSTIC CENTRES BY DISTRICT

Sl. No	Name of the Units.	Address	Services Catered
236	North East Diagnostics	148, Jessore Road, Block-B, 1st Floor, Dum Dum, North 24	Path
237	Northend Pathological Lab.ological Laboratory	A-43/A, Amarabati, Barasat Raod, Sodepur, North 24 Pgs.	Path
238	Orbis Eye & Dental Day Caare Center	4, Thakur Das Banerjee Road, Belghoria, Kolkata - 56, North 24	Path
239	Orchid Diagnostic Center	18(10), Ghosh Para Road, P.O. Barrackpore, North 24 Pgs.	Path
240	P. Chakraborty X-Ray Center	Golghar, Jagatdal, North 24 Pgs	X-Ray
241	P.S. Laboratory	Maya Super Market, Station Road, Duttapukur, North 24 Pgs	Path
242	Pariksha (Pathological Lab. Lab)	Kanchrapara, North 24 Pgs	Path
243	Pariver Seva Clinic	P.O.: Nabapally, P.S.: Barasat, North 24 Parganas	Path
244	Pathological Lab.o Diagnostic	Nabapally, Barasat, North 24 Pgs	Path
245	Pathological Lab.o Treat Diagnostic Center & Polyclinic	75, Dum Dum Road, Dum Dum, North 24 Parganas	Path
246	Pathological Lab.o World	Bagha Jatin Road, Kolkata - 36	Path
247	Pathological Lab.-O-Lab Diagbostic Center	Agarpara, North 24 Pgs	Path
248	Pathological Lab.onova Diagnostic Center	Belghoria, Kolkata - 700 056	Path
249	Paul X-Ray & Ultrasonography	Jorakalibari, Ashrampara, Basirhat, North 24 Pgs	X-Ray
250	People's Diagnostic Center	Feeder Road, Belghoria, Kolkata - 56	Path
251	Perfect Asha Diagnostic Center	Basirhat, North 24 Pgs	Path
252	Podder Medical & Pathological Lab.ological Lab,	Bangoan, North 24 Pgs	Path
253	Polyview Laboratory	B.T. Raod, Agarpara, North 24 Pgs	Path
254	Prantik Shastha Sadan (P) Ltd.	AC-210, Salt Lake City, Sector - I, Kolkata - 64	Path
255	Pratikkhan	Berachampa, Barasat, North 24 Pgs.	Path, X-Ray
256	Previna Pathological Lab.ological Laboratory	Bagdah Natun Bazar, P.O. & P.S.: Bagdah, North 24 Pgs	Path
257	Prodisha Clinical Laboratory	Amlapara, Bongaon, North 24 Pgs	Path
258	Pujali Municipality Diagnostic Center	T-4B, Sree Mohan Lane, Kolkata - 700 026, North 24 Pgs.	Path
259	Pulse Diagnostic Center	Central Road, Barrackpore, North 24 Pgs	Path
260	Punam Clinical Laboratory	Ratepara, Bongaon, North 24 Pgs	Path
261	Rahaman Laboratory	Basirhat, North 24 Pgs	Path
262	Rahara Polyclinic & zDiagnostic Center	Khardah, Nadia	Path
263	Rainbow	Govinda Niwas, P. S. - Rajarhat, Kol - 59	
264	Raj Pathological Lab.ological Laboratory	Rahara, North 24 Pgs	Path
265	Raja X-Ray Clinic	Court Road, Bongaon	X-Ray
266	Ramkrishan Medicare	Hridaypur, Barasat, Noth 24 Pgs	Path
267	Ranjan X-Ray Center	Naihati, Basirhat, North 24 Pgs	X-Ray
268	Royal X-Ray & U.S.G. Center	Moktarbari, Naihati, Badartola, Basirhat, North 24 Pgs	X-Ray
269	Rayland Diagnostic Center (P) Ltd.	13/13/1, Central Road, Barrackore, North 24 Pgs	Path
270	Rayland Diagnostic Center (P) Ltd. (Unit - II)	Barrackore, North 24 Pgs	Path
271	Red Cross Diagnostic Research Center	Agarpara, North 24 Pgs	Path
272	Reliable Pathological Lab.ological Laboratory	33/45, B.T. Road, Barrackpore, North 24 Parganas	Path
273	Reliance & Sarker Diagnostic Center	Bangoan, North 24 Pgs	Path
274	Reliance Diagnostic Center	New Ratepara, Bongaon, 24 Pgs (North)	Path
275	Reliance Diagnostics	AE, 337, Sector - I, Salt Lake City, Kol - 64, North 24 Pgs.	Path
276	Re-life Diagnostic Lab.	Gobardanga, North 24 Pgs	Path
277	Right Diagnostic Center	128, Kodalia, New Barrackpore, North 24 Pgs	Path
278	Rita Polyclinic & Diagnostic Center	New Barrackpore, North 24 Pgs	Path

LIST OF DIAGNOSTIC CENTRES BY DISTRICT

Sl. No	Name of the Units.	Address	Services Catered
279	Roy Clinical Laboratory	Naihati, North 24 Pgs	Path
280	Roy Diagnostic	Nonachandanpukur, Barrackpore, North 24 Pgs	Path
281	Roy Diagnostic Center	Kanchrapara, North 24 Pgs	Path
282	Roy's X-Ray & Ultra Sound Center	G.P. Road, Chowmatha, Ichapur, North 24 Pgs	Path, X-Ray
283	Ruby X-Ray	Lalkuthi, Barrackpore, North 24 Pgs	X-Ray
284	S. D. Clinic & Laboratory	265/A/44, B. T. Road, Kol - 36	Path
285	S. G. Diagnostic & Res. Center	Madhyamgram, North 24 Pgs	Path
286	S. Mukherjee Clinical Laboratory	Champadali, Barasat, North 24 Pgs	Path
287	Sahid Khudiram Bose Institute & Research Center	Belghoria, Kolkata - 700 056	Path, X-Ray
288	Sakti Diagnostic & Health Investigation Center	Panihati, 24 Pgs (N)	Path
289	Sampark Clinical Laboratory	496/A/1, Vivekananda Road, P.S.: Barasat, North 24 Parganas	Path
290	Sananda Diagnostic & Polyclinic Center	Santi Market, P.O.: Ghola, North 24 Pgs	Path
291	Sanjiban Diagnostic Center	Vill & P.O. & P.S.:Gopalnagar, North 24 Parganas	Path
292	Sanjivani Medical Institute	194, Jessore Road, Laketown, Kolkata - 89	Path
293	Santimoyee Clinical Laboratory	153/3, Old Court Road, Talpukur, Barrackpore, North 24 Pgs	Path
294	Sanyal Diagnostic Center	Tentulia, Swarupnagar, 24 Pgs (N)	Path
295	Sarkar X-Ray & Clinical Lab.	Hospital Road, Habra, North 24 Parganas	Path, X-Ray
296	Scientific Pathological Lab.o Lab	Gaighata, North 24 Pgs	Path
297	Scientific Pathological Lab.ological Center	Fingapara, North 24 Pgs.	Path
298	Seagull Diagnostic Center	Hazinagar, North 24 Pgs.	Path
299	Sero Clinical Lab	School Road Bongaon	Path
300	Seva X-Ray	Moktarbari, Naihati, Badartola, Basirhat, North 24 Pgs	X-Ray
301	Shakti Diagnostic & Health Investigation Center	Panihati, 24 Pgs (N)	Path
302	Shibananda Polyclinic & Diagnostic Center	Udayrajpur, North 24 Pgs	Path
303	Shine Laboratory	Ashoknagar, North 24 Pgs	Path
304	Shree X-Ray & Scan Center	278, New Market, Post Office Road, Habra, North 24 Pgs	X-Ray
305	Shyamnagar X-Ray Clinic	Pinkol More, Shyamnagar, 24 Pgs (N)	X-Ray
306	Soham Diagnostic Laboratory	19/17/A, Purba Govt. Colony, Rahara, North 24 Parganas	X-Ray
307	Soma Clinical Diagnostic & Research Center	Mathpukur, Kholapota, Basirhat, North 24 Pgs	Path
308	Sono Care	13/2, P.L. Chatterjee Lane, P.O.: Krishnanagar, Nadia	Path
309	Spandan Diagnostic Polyclinic Center	Ghola, North 24 Pgs	Path
310	Sree Durga Polyclinic	Palta, North 24 Pgs	Path
311	Sree Maa lab.	Amdanga, North 24 Pgs	Path
312	Sree X-Ray & Scan Center	127/33, Jessore Road, Barasat, North 24 Pgs	X-Ray
313	Sree X-Ray & Scan Center	Habra, North 24 Pgs	Path, X-Ray
314	Sreema Diagnostic	Narayanpur, North 24 Pgs	Path
315	Sreema Lab	Amdanga, North 24 Pgs	Path
316	Sreema X-Ray Clinic	Bhadratola, Basirhat, North 24 Pgs	X-Ray
317	Sri Krishna X-Ray & U.S.G.	Habra, North 24 Pgs	Path
318	Suibodh Mitra Cancer Hospital & Research Centre	Rudrapur, North 24 Parganas	Path
319	Sumangal Diagnostic Center	156/1, B. T. Road, Kolkata - 108	Path
320	Sun Clinical Laboratory	99/61, Jessore Road, Nagerbazar, Kolkata - 28	Path
321	Sunanda Diagnostic Center	Baduria, North 24 Pgs.	Path
322	Sundarban X-Ray Clinic	Hasnabad Old Market, North 24 Pgs	X-Ray

LIST OF DIAGNOSTIC CENTRES BY DISTRICT

Sl. No	Name of the Units.	Address	Services Catered
323	Sunimoy Pathological Lab.ological Center	Katiahat, Baduria, North 24 Pgs	Path
324	Super Clinical Laboratory	4, B. T. Road, Kolkata - 56	Path
325	Super Polyclinic	Habra, 24 Pgs(N)	X-Ray
326	Super Sonex Imaging Center	B. T. Road, Belghoria, Kolkata	U.S.G
327	Suraksha Diagnostic (P) Ltd.	A-51, VIP Park, Kestopur, North 24 Parganas	Path
328	Sure & Cure	Basirhat, North 24 Pgs	Path
329	Susrut Eye Foundation & Research Center Diagnostic	HB - 36 / A / 1, Salt Lake Kol - 106	Eye Care
330	Swaranika Medical Centre & Polyclinic	36, South Station Road, Agarpara, P.S.: Khardah, North 24	Path
331	Swarnajoyti Diagnostics,	11, Lenin Sarani, Kanchrapara, North 24 Parganas	Path
332	Swasti Diagnostic	Rajarhat Road, North 24 Pgs.	Path
333	Tandra Pathological Lab.ological Laboratory	Chandipara Bazar, North 24 Pgs	Path
334	Tarakeswar Pathological Lab.ological Laboratory	Panchpota, North 24 Parganas	Path
335	Tarakanath X-Ray Clinic	Chakdaha Road, Champaberia, Bongaon	X-Ray
336	Test Pathological Lab.ology Lab.	Sodepur, North 24 Pgs.	Path
337	The Central X-Ray Clinic & Opticals	Taki Road, Deganga, North 24 Pgs.	X-Ray
338	The Clinical Laboratory	Panihati, 24 Pgs (N)	Path
339	The Diagnos Clinic Lab	Garifa, North 24 Pgs	Path
340	The Kiran X-Ray Clinic	Thakumagar, North 24 Pgs	X-Ray
341	The Mordern Pathological Lab.ological Laboratory	Barasat, North 24 Pgs	Path
342	The New Dakshinaswar Laboratory	49 / A, Joyshree Nagar Dakshineswar, Kolkata - 76	Path
343	The Nirnoy	Masalandapur, Habra, North 24 Pgs	Path
344	The Pathological Lab.o	Sodepur, North 24 Parganas	Path
345	The Rainbow Clinical Lab	Gandhi Colony, P.O.: Bongaon	Path
346	The Spandan Diagnostic Center	K.N.C. Road, Barasat, 24 Pgs (N)	Path
347	Thyrocare Pathological Lab.ological Laboratory	Basirhat, North 24 Pgs	Path
348	Thyrocare Services	H/1-2, V.I.P. Road, Baguihati, Joramandir, Kol - 59, North 24 Pgs	Path
349	Treatment Polyclinic & Day Care Center	7/B, Motijheel Avn. Kol - 74	Path
350	Trust Diagnostic	Jessore Road, Habra, North 24 (N)	Path
351	U. S. Diagnostic Center	594, Jessore Road, Nager Bazar, Kol - 28, North 24 Pgs.	Path
352	Ultra Care Diagnostic & Research Center	Barasat, North 24 Pgs	X-Ray
353	Uma Medical Related Institute (Pstological Lab)	Teghoria, VIP Road. North 24 Parganas	Path
354	Unicom Diagnostic	Badartola, Basirhat, North 24 Pgs	Path
355	Unicom Diagnostic	Naihati, North 24 Pgs	Path
356	Unimed Diagnostic (P) Ltd.	P-166, Lake Town, Block - A, North 24 Pgs	Path
357	Unique Diagnostic	Nabapally, Barasat	Path
358	Unique Pathological Lab.ology Center	Kanchrapara, North 24 Pgs	Path
359	United X-Ray	Ghola, North 24 Pgs	X-Ray
360	Upasana Diagnostic & Research Center	AD - 71, Salt Lake, Sector - I, North 24 Parganas	Path
361	Usthi Foundation Lab	DumDum, North 24 Pgs.	Path
362	V.I.P Apex Medical Center (P) Ltd.	Madhyamgram Rural Hospital	Path
363	Varasha Diagnostic Center	Kazipara, Barasat, North 24 Pgs	Path
364	Vivekananda Specialist & Physiotherapy Center	57/A, Jessor Road, Barasat	Physiotherapy
365	Vivkananda Pathological Lab.ological Clinic	B. T. Road, Khardah, North 24 Pgs	Path
366	We Care U	R. B. C. Road, Barasat, North 24 Pgs	Path

LIST OF DIAGNOSTIC CENTRES BY DISTRICT

Sl. No	Name of the Units.	Address	Services Catered
367	Xpan's Diagnostic Centre	30/11/4, S. M. Ali Road, Barrackpore, Kolkata- 120	Path
368	Madhurima Pathological Lab.ological Centre	Thuba Chowringhee, Dist. North 24 Parganas	Path
369	S. C. Paul Diagnostic Centre	Andhirmath, PO. & PS. Haroa, Dist. North 24 Parganas	Path
Numbers of Path Lab: 312 ; Blood Bank: 0 ; Dental Clinic: 4 ; Forensic Lab: 0 ; Eye Care: 3			
PURULIA			
1	A.G. Diagnostic	Shakuntala Complex, Ranchi Road, Dist. Purulia	USG
2	Anandalok Polyclinic	K.N. Chakraborty Lane, Munseff Danga, Dist. Purulia	POLYCLINIC
3	Anusandhan Diagnostic Centre	Raghunathpur, Raniganj Road, Dist. Purulia	Path
4	Aviskar Diagnostic	L. M. Ghosh Street, Purulia	Path
5	Bikshan Pathology	S.B. Lane, Museff Danga, Dist.: Purulia	Path
6	Bikshan Pathological Lab.	Vill + PO. : Manbazar, Dist. Purulia	Path
7	Chails Diagnostic Laboratory	B.T. Sarkar Road, Zilla Scool More, Dolmi Nadhia, P.O. & Dist.:	Path
8	Chatterji X - Ray Clinic	Palaskola, Kashipur Road, Adra, PS. Kashipur, Dist, Purulia	X RAY
9	Clinical Diagnostic Centre	Jamtoria, PS. Boro, Dist. Purulia	Path
10	Clinical Laboratory Manbhumi Ultra Sound X Ray Clinic	Doctordanga, Chaibasa Road, Purulia	X RAY
11	Clinical Laboratory X Ray Clinic	L. M. Ghosh Street, Purulia	X RAY
12	Chawdhury Pathological Lab.	Sarkar Para, Raghunathpur, Dist. Purulia	Path
13	Dipti Diagnostic X-Ray Clinic	Barakar Road, Raghunathpur, Dist. Purulia	X RAY
14	Dipti Diagnostic USG Centre	Barakar Road, Raghunathpur, Dist. Purulia	USG
15	Deben Mahato (Sadar) Hsptl	Purulia Sadar Hospital, Dist. Purulia	USG
16	Divine X-Ray	T.C. Dey Street, Rash Maidan, P.O. & Dist.: Purulia	X RAY
17	Dutta Polyclinic	L.M. Ghosh Street, Museff Danga, Dist. Purulia	POLYCLINIC
18	Gayetri Diagnostic Centre [for USG 2/1 part]	Hattola Raod, RN Pur, Dist. Purulia	USG
19	Gita X-ray Clinic	Mini Plaza Market, Raniganj Road, RN Pur, Dist. Purulis	X RAY
20	Joyti Optical	G.N. Mukherjee Street, Saheb Bandh Road, Purulia	Path
21	Jhalda Path. Clinic	PO. Jhalda, Dist. Purulia	Path
22	Jhalda Polyclinic	PO. Jhalda, Dist. Purulia	POLYCLINIC
23	Jhalda X-ray Clinic	PO. Jhalda, Dist. Purulia	X RAY
24	Kalyani Path. Lab	Anandanagar, Vill+PO.: Jhalda, Dist. Purulia	Path
25	Kamala Patho Clinic	Balarampur, Ragistry Para, Rangadih, Dist.Purulia	Path
26	Kusum Diagnostic Centre	Balarampur Old Hospital, Rangadih, Dist.Purulia	Path
27	Laxmi X-Ray Clinic	Main Road Jhalda, P.O.:Jhalda, Dist. Purulia	X RAY
28	Life Line Diagnostic Centre	Sarat Sen Compound, Amdiha Nadiha, Dist. Purulia	Path
29	Life Line Diagnostic Centre	Sarat Sen Compound, Amdiha Nadiha, Dist. Purulia	EEG
30	Lolnath X-Ray Clinic	Vill+P.O.: Bandwan, Dist. Purulia	X RAY
31	Lolnath X-Ray Clinic	Coockes Compound, Dist. Purulia	X RAY
32	M. S. Roy Ultrasound Clinic	Main Road, (P.N. Ghosh Street, Purulia	USG
33	Mahamaya X-Ray Clinic	Raghunathpur Bankura Road, Dist. Purulia	X RAY
34	Maa Annapurna Pathologic Clinic	Barabazar Road, Balarampur, P.O.: Rangadih, Purulia	Path
35	Mandhum Ultrasoound X-Ray Clinic,	Daktradanga, Chaibasa Road, P.O. & P.S. & Dist.: Purulia	USG
36	Mandhum Diagnostic Centre	Palaskola, Adra, PS. Kashipur, dist, Purulia	Path
37	Mandhum Path. Clinic,	Vill+PO.: Bandwan, Dist. Purulia	Path
38	Mandhum Path. Clinic,	Poddar Para, Manbazar, Dist. Purulia	Path
39	Medical Investigation Center	Huchukpara, Purulia	Path

LIST OF DIAGNOSTIC CENTRES BY DISTRICT

Sl. No	Name of the Units.	Address	Services Catered
40	Medicare Investigation Centre	N.L. Ghosh Street,Laxmi Complex, Dist. Purulia	Path
41	Medicity Diagnostic Centre	L.M. Ghosh Street,Museff Danga, Dist. Purulia	Path
42	Medico Pathological Care & Cancer Detection Centre	Dist. Purulia	USG
43	Mediscan Sushama Medical Diagnostic Centre	Raghunathpuur, Dist. Purulia	USG
44	Micro Lab	N.L. Ghosh Street, Purulia	Path
45	Moden Pathology	Vill. & P.O.: Bandwan, Dist.Purulia	Path
46	Mordern Pathology	253, West Lake Road, Dist.Purulia	CT Scan
47	Mordern Pathology	253, West Lake Road, Dist.Purulia	Path
48	Mordern X-Ray & Research	253, West Lake Road, Purulia	X RAY
49	Mordern X-Ray & Research	253, West Lake Road, Purulia	USG
50	Nirmoy Polyclinic & Pathological Diagnostic Center	S. B. Lane, Museff Danga, Dist.Purulia	Path
51	Nripendra Diagnostic Centre	N.C. Dasgupta Road, Chakbazar, Dist. Purulia	POLYCLINIC
52	Nripendra Diagnostic ECG Centre	Chaibasa Road, Dist. Purulia	ECG
53	Nripendra Diagnostic USG Centre	Chaibasa Road, Dist. Purulia	USG
54	Nityananda Polyclinic	Laulara, Dist. Purulia	POLYCLINIC
55	Paramananda Allopathy Cahritable Dispen.	Bharat Sevashram Shangha , Dist, Purulia	Path
56	Pampa X-ray Clinic	Vill+PO.: Manbazar, Dist. Purulia.	X RAY
57	Pasteur Pathological Ltd.	Vill. & P.O.: Chelyama, Purulia	Path
58	Pathological Center	R.N. Pur Station Road, Adra South, Purulia	Path
59	Pathological Clinic	Manbazar, Dist. Purulia.	Path
60	Pathological Clinic	N.C. Dasgupta Road, Dist. Purulia	Path
61	Pathoview Diagnostic Research Laboratory	Kalitala Lane, Chowkbazar, Purulia	Path
62	Pritam Pathological Laboratory	Jhandapara, P.O. & P.S.: Raghunathpur, Dist. Purulia	Path
63	Puja Polyclinic	Sarbananda Sarkar Road, Munsiff Danga	POLYCLINIC
64	Purulia Medico Pathological Care Unit	N.C. Dasgupta Road, Dist. Purulia	USG
65	R.G. Polyclinic USG Centre	Gola Road, Jhalda, P.O.: Masina, Dist. Purulia	USG
66	Ramkrishna Path. Clinic	Subhas Nagar, PO.: Adra, Dist. Purulia	Path
67	Ramkrishna X-Ray Clinic	Dosadih, Anara, Dist. Purulia	X RAY
68	Ray Ultrasound & X-Ray Clinic	P.N. Ghosh Streert, Kataruka Market, Dist. Purulia	USG
69	S.D. Hospital - Raghunathpur	Raghunathpur, Dist. Purulia	USG
70	Sidhartha Diagnostic	Saheb Bandh Road, Dist. Purulis	USG
71	Sidhartha Diagnostic	Ragistry Para, Rangadih, Purulia	Path
72	Sidhartha Diagnostics	S. N. Sarkar Road, Munsidanga, P.O. & Dist.: Purulia	Path
73	Sidhartha Diagnostics	Uppar Nadhia, Zilla School More, Dist. Purulia	Path
74	Spandan Diagnostic Center	Chaibasa Road, Upper Nadiha, Purulia	Path
75	Subarna Laboratory	Chaibasa Road (Bishudha Medical Hall), Dist. Purulia	Path
76	Sushrut Diagnostic Laboratory	Super Market, Room No. 6-15 Hattola, Chaibasa Road, Dist.Purulia	Path
77	Ujjala Polyclinic	Vill+P.O.: Bandwan, Dist. Purulia	POLYCLINIC
78	USG Center Manbhun Ultra Sound X Ray Clinic	Dakter Danga, Purulia	X RAY
79	USG Center Mordern X - Ray & Research	West Lake Road, Purulia	X RAY
80	USG Center Roy Ultra Sound X - Ray Clinic	Barakar Road, Purulia	X RAY
81	USG Center Siddharta Diagnostic	Amlapara, Purulia	USG
82	X - Ray Clinic	N.C. Dasgupta Road, Dist. Purulia	X RAY
83	X - Ray Clinic	G.M.M. Road, Nadiha, Dist. Purulia	X RAY
	Numbers of Path Lab: 38 ; Blood Bank: 0 ; Dental Clinic: 0 ; Forensic Lab: 0 ; Eye Care: 0		

LIST OF DIAGNOSTIC CENTRES BY DISTRICT

Sl. No	Name of the Units.	Address	Services Catered
SOUTH 24 PARGANAS			
1	Accurate Diagnostic Pathological Laboratory	New Town, D. H. Road, South 24 Parganas	Path
2	Adhunik X Ray & Laboratory	New Town, D. Harbour , South 24 Pgs	X RAY
3	Advance Nuro Psychiatry Inst.	kalua, Joka, Thakurpukur	OPD
4	Alameen Polyclinic	Vill.: Chakdahat, P.O.: Husury, P.S.: Magrahat, South 24 Parganas	Path
5	Aliya Diagnostic	Magrahat, South 24 Parganas	Path
6	Amardeep Health Center	Sreenagar Main Road, Kolkata - 94, South 24 Pgs.	Path
7	Arogyabhawan Nursing Home & Pathology	Ghatakpur	Path, X-Ray
8	Ayur Bikshan Lab	Haridhan Chakraborty Sarani, Sonarpur	Path
9	B.N.S. Clinic	78,Raj Narayan Park,Uttar Shreepur,,Boral,South 24 Pgs.	Path
10	Baruipur Globe Nursing Home & Society	Sahajan Road, Baruipur, South 24 Parganas	Path
11	Baruipur Scientific Lab	BaruipurRail Gate, Baruipur	Path
12	Bata Worker's Benefit Society (O. P. D.)	Near Bata Factory, Maheshtala	OPD
13	Bhattacharjee Diagnostic	Vill & P.O.: Basanti, South 24 Parganas	Path
14	Bhattacharjee Diagnostic Center	Ghoshpara, Canning Town, South 24 Parganas	Path
15	Bhowmick Enterprise	Netaji Pally, Kamrabad, Sonarpur, Kol - 150, South 24 Parganas	Path
16	Bio lab Diag. Clinic	Dakshin Barasat, Joynagar	Path
17	Bishnupur Clinic & Diagnostic Center	C/O Amtala Rural Hospital Center, D.H. Road, Amtala, P.O.: Kanyanagar, Bishnupur, South 24 Parganas	X RAY
18	Bojerhat Hayat Diagnostic Center	Bojerhat, Bhatipota, Tardaha, P.S.: K.L.C., South 24 Parganas	Path
19	C. M. M. X Ray Clinic	Kulpi Road, Dakshin Barasat	X RAY
20	Cliniquet Diagnostic Center	Ramchandrapur, P.O.: R.C. Thakurpukur, Kol - 104, South 24	Path
21	Das X Ray Clinic	M. Durga, Pathar Pratima	X RAY
22	Debjani Polyclinic	Companier Thek, Bamacharak Genge	OPD
23	Deepshika Clinic	Baligada, Narayanpur, South 24 Parganas	Path
24	Diagnostic Center & Polyclinic	P.O.: Harinavi, Hariharitala, Kolkata - 146, South 24 Parganas	Path
25	Diamond Park Nursing Home	Diamond Park, Joka	Path
26	Dipanjan Policlinic & Diag Lab	Canning Town	Path
27	Dr. Das Nursing Home & Pathology	New Town, D. Harbour	X RAY
28	Dr. Das Nursing Home (Path)	New Town, D. Harbour , South 24 Pgs	X RAY
29	Dr. Harinath Ghosh Memorial X Ray Clinic	Mojilpur, Dhannantori Rd,Joynagar	X RAY
30	FMC Healthcare Services (P) Ltd.	439, Kalibishnupur Road, Baruipur, South 24 Pgsd.	Path
31	Ganga Diagnostic	Bakrahat, Raipur More, South 24 Parganas	Path
32	George Eye Clinic	Chakmir, Zmaheshtala, Kolkata - 700 141	Eye
33	Gouri Polyclinic & Diagnostic Center	Goria Station Rd, Goria	Path
34	Green View Diagnostic Center	Amtala, Kanyanagar	X RAY
35	Haque Clinical Laboratory	Sangrampur, P.S.: Usthi, South 24 Parganas	Path
36	Herbicure (P) Ltd.	7 & 8 Metro Garden City, P.O.: Pailan, P.S.: Bishnupur, South 24 Parganas	Path
37	Hindusthan Health Point Pvt. Ltd.	2406, Garia main Road	X RAY
38	Ideal Diagnostic Center	P.O.: Gocharan , P.S.: Baruipur	Path
39	Ideal X-Ray Clinic	New Town, Diamond Harbour Road, South 24 Parganas	Path
40	Indu X Ray Clinic	Subudhipur, Baruipur	X RAY
41	Jibandwip	7 No, Dighirpar, Canning Town	X RAY

LIST OF DIAGNOSTIC CENTRES BY DISTRICT

Sl. No	Name of the Units.	Address	Services Catered
42	Jivan Deep X-Ray Clinic & Laboratory Center	Vill. & P.O. : Sharkol, P.S.: Usthi, South 24 Parganas	Path
43	Kasturi Diag . Center	Thakurpukur, 3A Bus Stand	Path
44	Kasturi Polyclinic	Thakurpukur, 3A Bus Stand	Path
45	Leaders Health Care (P) Ltd.	Vill.: Hsaridevpur, Noorpur Road, P.O.: Sarisha Ashram, P.S.: Diamond Harbour, South 24 Parganas	Path
46	Life Guide Diagnostic	Champahati, Bishnupur	Path
47	Life Line Hospital & Pathology	Kamalgachi, Narendrapur	Path
48	Life Line Hospital & Pathology	Kamalgazi, Narendrapur	CT SCAN
49	Loknath Pathological Center	Joynagar - Mojilpur, South 24 Parganas	Path
50	M. P. Birla Foundation Medical Society Unit	Birlapur Hospital, Birlapur, Budgebudge	Path
51	Marlin Diagnostic Center	Subarna Apartment, Shop No. 14,15,16, Srinagar Main Rd. Kol - 94	X RAY
52	Mass Education Women & Child Hospital polyclinic	Dakshin Kumarkhali, Sonarpur	OPD
53	Mass Education Women & Child Hospital polyclinic	Dakshin Kumarkhali, Sonarpur	X RAY
54	Maternity & Child Welfare Cent. & Urban Welfare Cent.	Joynagar Municipality	OPD
55	Medibase Diagnostics	Batamore, Maheshtala, South 24 Parganas	Path
56	Medicade Diagnostic Center	Joka, Bakrahat Road, South 24 Parganas	Path
57	Medicare	Vill. & P.O. & P.S.: Namkhana, South 24 Parganas	Path
58	Medilab	Sonarpur Station Road, Opp. Power House, Sonarpur, South 24	Path
59	Micro Diag & Pathology	Baruipur, Duttapara	Path
60	Micro Lab. Pathological Clinical	325/1, Netaji Subhas Road, Joynagar	Path
61	Mordern Diagnostic Center	Mouza: Radhaballavpur, P.O. & P.S.: Basanti, South 24 Parganas	Path
62	Mordern Pathology & Diagnostic Center	Newtown, D. Harbour, South 24 Parganas	Path
63	Mordern X- ay Clinic	Kulpi Road, Kalitala, Baruipur Road, South 247 Parganas	X RAY
64	Mordern X-Ray & Ultrascan	Jetty Ghat, Madhabpur, P.O.: D. Harbour, South 24 Parganas	X RAY
65	Mukherjee Diagnostic Center	B-7, Rajnarayan Park, Boral, Kolkata - 700 154, South 24 Parganas	Path
66	Namita Nursing Home & Diagnostic Center	Baruipur, Kachari Bazar	Path
67	Neon Healthcare & Research Institute Ltd.	S-16, Phase - III, kasba Industrial Estate, Kolkata - 700 107	Path
68	New Allied Diagnostic Center	Garia Natun Hat (Near South Point Nursing Home), South 24	Path
69	New Dabendra X - Ray Clinic	Baruipur, Kachari Bazar	X RAY
70	New Medical Center	Mograhat, South 24 Parganas	Path
71	New X Ray Clinic	New Town D. Harbour, South 24 Parganas	X RAY
72	Niramoy Polyclinic	Uttar Kalikapur, Dakshin Barasat, South 24 Parganas	Path
73	Parivar Seva Sanstha	96 Deshpran Shasmal Road, Howrah	Path
74	Pathological & ECG Center	58B, Dr. S. N. Ghosh Road,P.O. & P.S.: Budge Budge, South 24 Parganas	Path
75	Popular Clinic & Laboratory	Kanyanagar, Amtala	Path
76	Popular X Ray Clinic	Kakdwip	X RAY
77	Popular X-Ray Clinic	P.O.: Kakdwip, South 24 Parganas	Path
78	Puspa X Ray Clinic	Garia Station Road	X RAY
79	R. D. Memorial	Vidyanagar, Charshyamdas	Path
80	R. M. X Ray Clinic	Thakurpukur, 3A Bus Stand	X RAY
81	Rabi Rashmi Medical Center	Dakshin Barasat, Joynagar	X RAY
82	Rabindra Nagar Diagnostic Center	B-60, Rabindra Nagar, P.O.: Bartala, P.O. & P.S.: Rabindra Nagar, South 24 Parganas	Path

LIST OF DIAGNOSTIC CENTRES BY DISTRICT

Sl. No	Name of the Units.	Address	Services Catered
83	Rajpur X-Ray & Pathology	1101, Aghore Sarani, P.O.: Rajpur, P.S.: Sonarpur, Kolkata - 149, South 24 Parganas	Path, X-Ray
84	Ratnadeep	Kulpi, (Near Baruipur Rail Gate)	Path
85	Red Plus Diagnostic Center	Indira Gandhi Road, Bansghat, Canning Town, South 24 Parganas	Path
86	Rekha Medicure Clinic	Narayanpur, P.O. & P.S.: Usthi, South 24 Parganas	Path
87	Relief Diag Cent.	Kulpi	Path
88	Remedy Medical Pvt. Ltd.	Garia main Road	ENDOSCOPY
89	Remedy Medical Research Inst. Pvt. Ltd.	Tribeni Apartment, Garia main Road, Kol - 84	Path
90	Santi Laboratory	P.O. & P.S.: Basanti, North 24 Parganas	Path
91	Santoshpur Diagnostic Center	Santoshpur, Kalinagar More, P.O.: Bidhangarh, South 24 Parganas	Path
92	Santoshpur patho Clinic	Gini Market, 1st Floor, Santoshpur, Station Rd. Bidhangarh	Path
93	Santoshpur X ray Clinic	Gini Market, 1st Floor, Santoshpur, Station Rd. Bidhangarh	X RAY
94	Sarkar Medical Diagnostic Center	Vill: Nayapara, Kakdwip, South 24 Parganas	Path
95	Satabdi Diag Cent.	Rail Gate, Baruipur	X RAY
96	Satya Polyclinic	Joynagar, South 24 Parganas	Path
97	Satyajit Diagnostic Center	Netaji Subhas Road, Joynagar	Path
98	Scientific Diagnostic Center	Dakshin Barasat, S - 24 Pgs	Path
99	Seanight Hospital & Welfare Society	Bakrahat, Rasapunja, South 24 Parganas	Path
100	Seba Scientific Clinical Lab	New Town, D. Harbour	Path
101	Serological Clinical lab.	Nangipar bangla, Batanagar	Path
102	Serological Clinical laboratory	Nangiparbangla, Swapan Kanan, Batanagar	Path
103	Seva Bhabhan Diagnostic & Polyclinic	Kakdwip, South 24 Parganas	Path, X-Ray
104	Seva Diagnostic Center	Beliadanga, P.O.: Dakshin Barasat, P.S.: Joynagar, South 24 Parganas	Path
105	Shibrampur Diagnostic Center	Jote Shibrampur, P.S.: Mahestala, South 24 Parganas	Path
106	Shis Eye Care Hospital	Bhangore,	Eye
107	Shrima Diagnostic Center	Sarisha, 246 More, D. H. Road, South 24 Parganas	Path
108	Snehalata Clinical Laboratory	Ramgarh, South 24 Parganas	Path
109	South End	Sarengabad, P.O.: Budge Budge, P.S.; Maheshtala, Kol - 137,	Path
110	Southern Clinic	225, Rakhai Ghosh Road, Gajipur More, Rajpur Sonarpur Municipality, South 24 Parganas	Path
111	Spandan Medicare	16, N.S. Road, Kodalia, Battala, Kolkata - 700 146, Rajpur-Sonarpur Municipality, South 24 Parganas	Path
112	SPG College of Health Sciences	Jogibattala, Opp. Bishop Home, Baruipur, Kolkata - 700 145, South 24 Parganas	Path
113	Standard X Ray Clinic	P. O. D. Harbour, (Near U.C.O. Bank)	X RAY
114	standard Clinical Laboratory	522, D. H. Road, Kol - 34	Path
115	standard Clinical Laboratory	D. Harbour, U. Co. Bank	Path
116	Subartnarakha Clinical Lab	Tentulberia, Garia	Path
117	Sundarban Diagnostic Clinic	Kakdwip	Path
118	Suprim Clinical Laboratory	Mallickpur, Vaya Malancha, Mahinagar	Path
119	Suraksha X Ray Clinic	Amtala N.D. Road. Bishnupur	X RAY
120	Suraksha X-Ray Clinic	Gobardhanpur, P.O.: Kakdwip, South 24 Parganas	X RAY
121	Suswasthya	29, N. S. Road, P.O.: Joynagar-Mojilpur, P.S.: Joynagar, South 24 Parganas	Path

LIST OF DIAGNOSTIC CENTRES BY DISTRICT

Sl. No	Name of the Units.	Address	Services Catered
122	Swastha Diagnostic Center & Poly Clinic	12/9, Netaji Subhas Bose Road, Joynagar, South 24 Parganas	Path
123	Temple X Ray	125, N.S. Road, Rajpur, Kalitala	X RAY
124	The Central Diagnostic Center	Amtala, D. H. Road, South 24 Parganas	Path
125	Tribeni Medical Center	Pratapgarh, Binavila, Narandrapur, Kolkata - 103, South 24 Parganas	Path
126	Uttaran Drug De-Addictaion Center	Pailanhat, D. H. Road, South 24 Parganas	Path
127	Welkin Medical Pvt. Ltd.	Garia Station Road. (Opposite Harimoti School)	Path
128	West Bengal Medical Center	Budge Budge Trank Road, South 24 Parganas	Path
129	X-Ray Center	58A, S. N. Ghosh Road, Budge Budge, South 24 Parganas	Path
Numbers of Path Lab: 93 ; Blood Bank: 0 ; Dental Clinic: 0 ; Forensic Lab: 0 ;			
UTTAR DINAJPUR			
1	Acurate Diagnostic Center	Ulka More, Itahar, Uttar Dinajpur	Path
2	Advance Patho Lab	S.P. Mukherjee Road, Islampur, Uttar Dinajpur	Path
3	Asha X-Ray	Hospital Road, Kaliagunj, Uttar Dinajpur	X-Ray
4	Bharat Diagnostic	Ajad Nagar, Ismail Chaque, P.O.: Islampur, Uttar Dinajpur	Path
5	Bharat Sevaashram Sangha Unit of Pranabananda Pathological Center	Debinagar, Raigunj, Uttar Dinajpur	Path
6	Bikshan Patho Lab	Ukilpara, Raigunj Uttar Dinajpur	Path
7	Chowdhury Laboratory	Municipal Mini Market, Room No. 11, Islampur, Uttar Dinajpur	Path
8	Chowdhury Patho Lab	Ukilpara, Raigunj Uttar Dinajpur	Path
9	Chowdhury X-Ray Clinic	Ukilpara, Raigunj Uttar Dinajpur	X-Ray
10	Chowdhury X-Ray Clinic	Station Road, Islampur	X-Ray
11	Clini Path Lab	Ukilpara, Raigunj Uttar Dinajpur	Path
12	Dalkhola Patho Lab	Dalkhola, Uttar Dinajpur	Path, X-Ray
13	Dishari Diagnostics	Hospital Road, Kaliagunj, Uttar Dinajpur	Path
14	Dolphin Diagnostic Center	Ukilpara, P.O. & P.S.: Islampur, Uttar Dinajpur	Path
15	Dr. Dey's Pathological Laborartory	Lion's Super Market, Kaliagunj, Uttar Dinajpur	Path
16	High Tech Patho Lab	Chakulia Hat, Chakulia	Path
17	Hira X-Ray	Dalkhola, Uttar Dinajpur	X-Ray
18	Husain X- Ray Clinic	Majidnagar, Ismail Chalk, Islampur	X-Ray
19	Islampur Laboratory	Municipal Mini Market, Islampur	Path
20	Jafar Patho Lab	Teenpool, Islampore	Path
21	Janakalyan Xray Clinic	Hospital Gate., Islampur	X-Ray
22	Kanki X-Ray	Kanki, Uttar Dinajpur	X-Ray
23	Karandighi Daignostic Center	Karandighi, Uttar Dinajpur	Path
24	Karandighi Diagnistic X-Ray Center	Karandighi, Uttar Dinajpur	X-Ray
25	L.Z. Pathology Center	Kahata, P.O. & P.S.: Chakulia, Uttar Dinajpur	Path
26	Life Care Patho Lab	Near Bus Stand, Islampur	Path
27	Life Line Patho Lab	Hospital Road, Kaliagunj, Uttar Dinajpur	Path
28	Life Line Pathology	Hospital Para, Islampur	Path
29	Life Line Ultrasonography	Hospitalpara, Islampur	U.S.G
30	Medicare Patho Lab	Sukanta More, Kaliagunj, Uttar Dinajpur	Path
31	Medinova Diagnostic	Satsangha Raod, Ukilpara, Raigunj, Uttar Dinajpur	Path
32	Meditech Pathological Laboratory	Old Station Pally, Islampur, Uttar Dinajpur	Path

LIST OF DIAGNOSTIC CENTRES BY DISTRICT

Sl. No	Name of the Units.	Address	Services Catered
33	Meditech Pathological Laboratory	Station Road, Kshudiram Pally, Islampur, Uttar Dinajpur	Path
34	Milan X-Ray Clinic	Teenpool, Islampore	X-Ray
35	Mordern Laboratory	C/o Pratima Medical Hall Islampur	Path
36	Mordern Patho Lab	Hospital Road, Kaliagunj, Uttar Dinajpur	Path
37	Naina Investigation Center	P.O.: Dalkhola, NH - 34, Uttar Dinajpur	Path
38	Nalini Clinic Patho Lab	M.G. Road, Islampur	Path
39	New Medi Lab	Shib Mandir Road, Islampur	Path
40	New Patho Lab	P.W.D. More, Islampur	Path
41	Nibedita Patho Lab	Ukilpara, Raigunj Uttar Dinajpur	Path
42	Niramoy Patho Lab	Hospital Road, Itahar	Path
43	Nirikha Patho Lab	Hospital Road, Kaliagunj, Uttar Dinajpur	Path
44	Nirupan Mediscan	Ukilpara, Raigunj Uttar Dinajpur	X-Ray
45	North Bengal Patholab	Ukilpara, Raigunj Uttar Dinajpur	Path
46	Paul X-Ray Clinic	Sukantapally, Islampur	X-Ray
47	Popular Diagnostic Center	Station Road, Islampur	Path
48	Pratima Clinical Patho Lab	K. G. Road, Dehashree More, Raigunj, Uttar Dinajpur	Path
49	Pratima Pathological Lab	Ukilpara, Raigunj Uttar Dinajpur	Path
50	Prova X-Ray	Ukilpara, Raigunj Uttar Dinajpur	X-Ray
51	Raiganj Jeevan Rakha Diagnostic (P) Ltd.	Ukilpara, P.O. & P.S.: Raiganj Uttar Dinajpur	Path
52	Raigunj Diagnostic Laboratory	Super Market, Comercial Estate Raigunj Block - II, Uttardianjpur	Path
53	Ramganj Diagnostic Center	Ramganj Bazar (Near Ismail Medical Store)P.O.: Ramganj, P.S.: Islampur, Uttar Dinajpur	Path
54	Rekha Ultrasonography	Ukilpara, Raigunj Uttar Dinajpur	U.S.G
55	Sandhya Diagnostic,	S. P. Mukherjee Road, Islampur	Path
56	Sanjeevani Diagnostic Center	Teenpool Chowk, P.O. & P.S.: Islampur, Uttar Dinajpur	Path
57	Sebayan Patho Lab	Ukilpara, Raigunj Uttar Dinajpur	Path
58	Sewa Pathological Lab.	P.O. & P.S.: Islampur, Uttar Dinajpur	Path
59	Sri Gobindo Patho Lab	New Market, Kanki, Uttar Dinajpur	Path
60	Suraksha Patho Lab	Netaji Pally, Raigunj Uttar Dinajpur	Path, X-Ray
61	Swewa Patho Lab	Teenpool, Islampore	Path
62	The Islampur Lab	Municipal Mini Market, Islampur	Path
63	The Life Line X-Ray Clinic	Hospital Para, Islampur	X-Ray
64	Ultrasonography	Ukilpara, Raigunj Uttar Dinajpur	U.S.G
65	Ultrasonography(C/o Alam Nursing Home)	Teenpool, Islampore	U.S.G
66	X-Ray Clinic	Teenpool, Islampore	X-Ray
67	X-Ray Inn	C/o Alam Nursing Home, Teenpool, Islampur	X-Ray
Numbers of Path Lab: 48 ; Blood Bank: 0 ; Dental Clinic: 0 ; Forensic Lab: 0 ;			
W. MIDNAPUR			
1	Adarsha Path Lab.	Bargidanga Hospital Road, Gopiballavpur, West Midnapur	Path
2	Amiya Pathological Laboratory	DVC Market, Mayapur, P.O.: Talbagachia, P.S.: Kharagpur, Paschim Medinipore	Path
3	Amiya X-Ray Diagnostic Center	Kharagpur, Paschim Medinipur	X-Ray

LIST OF DIAGNOSTIC CENTRES BY DISTRICT

Sl. No	Name of the Units.	Address	Services Catered
4	Amsol Diagnostic Center	Chottatengra (IIT Road), Kharagpur, West Midnapore	Path
5	Anirvan Diagnostic Center (P) Ltd.	C-20, Burdge Town, P.O.: Midnapur, P.S.: Kotwali, Paschim	Path
6	Apollo Pathological Lab.	Rabindranagar, P.O.: Midnapore, P.S.: Kotwali, West Midnapore	Path
7	Arogya Seva Niketan	C/o. Pinaki Ranjan Maity, Vill. & P.O.: Krishna Nagar, Paschim	Path
8	Asha Diagnostic Center	Rabindranagar, P.O.: Midnapore, P.S.: Kotwali, West Midnapore	Path
9	Astha Diagnostic & Analytic Center	Judges Court Road, Kotwali, West Midnapore	Path
10	Bacto Research Clinic	Malancha Road, P.O.: Nimpura, P.S.: Kharagpur, Paschim	Path
11	Banaphul Clinic	Prembazar (Hizli Co-operative), Kharagpur, West Midnapore	Path
12	Bengal Pathological & Diagnostic Centre	Vill.: Konnagar, P.O. & P.S.: Ghatal, Paschim Medinipore	Path
13	Binapani Diagnostic Center	P.O. & P.S.: Garbeta, Midnapore (W)	Path
14	Bindu Diagnostic & Research Center	236 Chantichak, Golebazar, Kharagpur, West Midnapore	Path
15	Biswas X-Ray & Path Lab.	P.O. & P.S.: Binpur, West Midnapore	Path, X-Ray
16	Care & Cure Path Lab.	Muransole, P.O. & P.S.: Belpahari, Midnapur (W)	Path
17	Chakraborty Laborty	Kushputa, Ghatal, West Midnapore	Path
18	Chakraborty Pathological Laboratory	Kharida, Malancha Road, P.O. & P.S.: KGP, Wset Midnapore	Path
19	Chandrakona Pathological Laboratory	Dakshin Bazar, Hospital More, Paschim Medinipore	Path
20	Das Polyclinic & X-Ray Diagnostic Center	Vill. & P.O.: Dasgram, P.S.; Sabang, Paschim Medinipore	X-Ray
21	Daspran Path Lab.	Tamuany, P.O.: Sekandary, P.S.: Daspur, West Midnapore	Path
22	Debi Pathological Lab.	Bacchurdoba, Jhargram, West Midnapore	Path
23	Diagaostic Laboratory	Library Road, P.O.: Midnapore, West Midnapore	Path
24	Diagnostic Center	Jharboni, P.O.: Amlagora, P.S.: Garbeta, Midnapore (W)	Path
25	Diagnostic Center	Dwarigeria, P.O.: Satbankura, P.S.: Garbeta, Midnapur (W)	Path
26	Diagnostic Clinical Laboratory	P.O.: Lutunia, P.S.: Sabong, West Midnapore	Path
27	Diagnostic Lab.	Library Road, P.O.: Midnapore, West Midnapore	Path
28	Diagnostic Laboratory	Natun Bazar, P.O.: Midnapore, P.S.: Kotwali, Midnapore (W)	Path
29	Dipalok Pathological Lab.	Shyamsundarpur, P.O.: Dharampur, P.S.: Daspur, West Midnapore	Path
30	Dipti Laboratory	Kushputa, Ghatal, West Midnapore	Path
31	Disha Pathological Laboratory	Keshabdihi, P.O.: Jhargram, P.S.: Kotwali, Paschim Medinipore	Path
32	Divine Diagnostic	P.O.: Madpur, Kharagpur, West Midnapur	Path
33	Doctor's Laboratory	Kushputa, P.O. & P.S.: Ghatal, Paschim Medinipore	Path
34	Dr. Prashanta Kumar Giri (Pathological Laboratory)	Raghunathpur, Jhargram, West Midnapore	Path
35	Dristi Pathological Laboratory	Rabindranagar, P.O.: Midnapore, P.S.: Kotwali, West Midnapore	Path
36	Ghatal Fertility Centre	Kushputa, Ghatal, West Midnapore	Path
37	Ghatal Pathological Laboratory	Kushpata, Ghatal, Paschim Medinipore	Path
38	Health Care Diagnostic	Rabindranagar, P.O.: Midnapore, P.S.: Kotwali, West Midnapore	Path
39	Ideal Diagnostic Center	Minpura, P.O. & P.S.: Kharagpur, Paschim Medinipore	Path
40	Iman Pathological Laboratory	Malancha Road, P.O.: Nimpura, P.S.: Kharagpur, Paschim	Path
41	Island Pathological Laboratory	P.O.: Inda, P.S.: Kharagpur, Paschim Medinipore	Path
42	Jeebandeep Pathology & X-Ray Center	Soyla, P.O.: Sonakhali, P.S.: Daspur, West Midnapore	Path
43	Jeevan X-Ray & Pathology	P.O. 7 P.S.: Belpahari, West Midnapore	Path
44	Jibandeeep Clinical Lab.	Basudebpur, P.O.: Khanjanchak, East Midnapore	Path
45	K.D. Pathological Lab.	Rabindranagar, P.O.: Midnapore, P.S.: Kotwali, West Midnapore	Path
46	Kharagpur Pathological Laboratory	P.O.: Inda, P.S.: Kharagpur, Paschim Medinipore	Path

LIST OF DIAGNOSTIC CENTRES BY DISTRICT

Sl. No	Name of the Units.	Address	Services Catered
47	Krishna Pathological Laboratory	Raghunathpur, Jhargram, West Midnapore	Path
48	Kundu Path Laboratory	P.O.: & P.S.: Goaltore, Kharagpur, West Midnapore	Path
49	Life Care Path Laboratory	Birsinghapur, P.S.: Pingla, West Midnapore	Path
50	Life Line Diagnostic	Rabindranagar, P.O.: Midnapore, P.S.: Kotwali, West Midnapore	Path
51	Life Line Pathological Investigation Centre	Ghota Tangra, P.O. & P.S.: Kharagpur, Paschim Medinipore	Path
52	Ma Sarada Diagnostic Center	P.O.: Ghatmura, P.S.: Garbeta, Paschim Medinipore	Path
53	Maa Durga X-Ray & Pathological Center	Kaushallya, P.O.: Kharagpur, Midnapore (W)	Path, X-Ray
54	Maa Sarada Pathological Laboratory & X-Ray	Chotkhelna, Madigram, Pingla, Paschim medinipore	Path
55	Mallik Laboratory	Burdge Town, West Midnapore	Path
56	Manab Scan Center	Raghunathpur, Jhargram, West Midnapore	Path
57	Manju Path. Lab.	Gokulchak, P.O.: Jalchak, P.S.: Pingla, Midnapore (W)	Path
58	Medicare Diagnostic Center	P.O.: Garbeta (Near Hospital), P.S.: Garbeta, Midnapore (W)	Path
59	Medicare Diagnostic Center & Polyclinic	Gokulchak, P.O.: Jalchak, P.S.: Pingla, Midnapore (W)	Path
60	Medico Path Lab.	Belpahari, West Midnapore	Path
61	Medilab Pathology Center	Baromohanpur, P.O.: Khakurda, P.S.: Belda, West Midnapore	Path
62	Medipath Diagnostic & Consultancy Center	Mitra Compound, P.O.: Midnapore, P.S.: Kotwali, Paschim	Path
63	Medland Pathological Lab.	P.O.: Habibpur, P.S.: Kotwali, West Midnapore	Path
64	MEDTECH	Station Road, Keranitala, West Midnapore	Path
65	Micro View Path. Lab.	Bagda, P.O. & P.S.: Mohanpur, West Midnapore	Path
66	Midnapore Pathology Lab.	P.O.: Lowada, P.S.: Debra, Midnapore (W)	Path
67	Midnapore Scan Center (P) Ltd.	Keranitola, P.O. & P.S.: Midnapore, Paschim Medinipore	Path
68	Mondal Pathological Lab.	Rabindranagar, P.O.: Midnapore, P.S.: Kotwali, West Midnapore	Path
69	Mordern Bacterio Clinical Laboratory	Bachurdoba, P.O. & P.S.: Jhargram, West Midnapore	Path
70	Mordern Bactro Clinical Lab.	Bachurdoba, P.O. & P.S.: Jhargram, West Midnapore	Path
71	Mordern Pathological Lab.	Binpur, West Midnapore	Path
72	Mordern X-Ray Clinic	Deulihat, P.O.: Sagareswar, P.S. Ramsagar, West Midnapore	X-Ray
73	Mukherjee Path. Lab.	Goalkaunchak, P.O.: Midnapore, West Midnapore	Path
74	Mumpy Scientific Lab. & X-Ray Clinic	Silda, P.S.: Binpur, West Midnapore	Path, X-Ray
75	N. G. Diagnostic (Pathology)	Ghoradhara, P.O. & P.S.: Jhargram,, Paschim Medinipore	Path
76	Nabajiban X-Ray & Pathological Laboratory	Kushpata, Ghatal, Paschim Medinipore	Path, X-Ray
77	New Medilab Pathological Laboratory	Rabindranagar, P.O.: Midnapore, P.S.: Kotwali, West Midnapore	Path
78	New Pathological Lab.	Raghunathpur, Jhargram, West Midnapore	Path
79	New Scientific Clinical lab.	Kalaberia, P.O.: Charabarh, P.S.: Bhagwanpur, West Midnapore	Path
80	New Scientific Laboratory	Kushputa, Ghatal, West Midnapore	Path
81	Nidan Pathological Center	Dakshinbazar, P.O. & P.S.: C.K. Town, Midnapore(W)	Path
82	Nightengle	Namarchawk (Miyabazar), P.O.: Midnapore, West Midnapore	Path
83	Nirikhhan Pathological Lab.	Hospital Road, Jhargram, West Midnapore	Path
84	Nirikhhan Pathological Lab.	P.O.: Khirpai, West Midnapore	Path
85	Nirnoy Path. Center	P.O. & P.S.: Garbeta, Midnapore (W)	Path
86	Nirnoy Pathological Lab.	Gobindanagar, P.O.: Chenchua Gobindanagar, P.S.: Daspur,	Path
87	Nitingale	Nannurchak (Miyabazar), P.O.: Midnapur, Kotwali, Midnapore (W)	Path
88	Pastur Pathological Laboratory	Belda, Paschim Medinipur	Path
89	Pathological Laboratory	Jhargram, Paschim Medinipur	Path
90	Pathological Research Laboratory	P.O.: Lutunia, P.S.: Sabong, West Midnapore	Path

LIST OF DIAGNOSTIC CENTRES BY DISTRICT

Sl. No	Name of the Units.	Address	Services Catered
91	Pathology Laboratory	Rabindranagar, P.O.: Midnapore, P.S.: Kotwali, West Midnapore	Path
92	Phenix Diagnostic	Raghunathpur, Jhargram, West Midnapore	Path
93	Prantik Diagnostic Center	Rabindranagar, P.O.: Midnapore, P.S.: Kotwali, West Midnapore	Path
94	Puspa Pathological Lab.	Rabindranagar, P.O.: Midnapore, P.S.: Kotwali, West Midnapore	Path
95	Raj Diagnostic	Rabindranagar, P.O.: Midnapore, P.S.: Kotwali, West Midnapore	Path
96	Raj Surgical & Diagnostic Clinic (P) Ltd.	Kaushallya, P.O. & P.S.: Kharagpur, Midnapore (W)	Path
97	Rishi Path Lab.	Dewanmore, P.O.: Nimpura, P.S. Kharagpore, Midnapur (West)	Path
98	Roy Diagnostic	Rabindranagar, P.O.: Midnapore, P.S.: Kotwali, West Midnapore	Path
99	Roy Diagnostic & Polyclinic	Chhototengra, P.O. & P.S.: Kharagpur, Midnapore (W)	Path
100	Roy Laboratory	Deuli, P.O. & P.S.: Belda, West Midnapore	Path
101	Roy's Polyclinic	Ghatal, Argorah, West Midnapore	Path
102	Rural Path Laboratory	P.O. & P.S.: Gopiballavpur, Midnapore (W)	Path
103	Safe Diagnostic Center	Bardget Town, P.O.: Midnapore, P.S.: Kotwali, Midnapore (W)	Path
104	Samadhan Diagnostic Center	Kushputa, Ghatal, West Midnapore	Path
105	Samanta Diagnostic	C.K. Road, P.O.: Satbankura, P.S.: Garbeta, West Midnapore	Path
106	Sarada Pathological Laboratory	Konnagar, P.O. & P.S.: Ghatal, Midnapore (W)	Path
107	Saratika Pathological Laboratory	P.O. Salua, P.S.: Kharagpur, Paschim Medinipore	Path
108	Satya Sai Diagnostic Center	Kharida, Malancha Road, P.O. & P.S.: KGP, Wset Midnapore	Path
109	Satyanarayan Pathological Lab.	Murakatha, P.O.: Keshiary, West Midnapore	Path
110	Scientific Laboratory	Jhargram, Paschim Medinipur	Path
111	Scientific Path Lab.	Dakshinbazar, P.O. & P.S.: Chandrakona Town, Midnapore(W)	Path
112	Search Diagnostic	Keranitola, P.O. & P.S.: Midnapore, Paschim Medinipore	Path
113	Seba Pathological laboratory	Natundihi, P.O.: Jhargram, West Midnapore	Path
114	Seva Pathological Lab.	P.O. & P.S.: Goaltore, Midnapore (W)	Path
115	Shiv Shakti Diagnostic Center	P.O.: Anandapur, P.S. Keshpur, Midnapur (W)	Path
116	Shree Clinical Laboratory	P.O. & P.S.: Sabang, West Midnapore	Path
117	Shree Krishna Diagnostic Center	Nuniagoda, P.O. & P.S.: Daspur, Paschim Medinipore	Path
118	Shree Shree Sarada Ashram (Mayer Bari) Sevayatan Homeopathic & Eye Clinic	Ballavpur (Barabazar), P.O.: Midnapore, West Midnapore	Eye Care
119	Shreema X-Ray & Pathological Laboratory	Asis Das Ashikary, Vill.&P.O.Latunia, Temathani, Midnapore(W)	Path
120	Shyamala Clinical & Research Laboratory	P.O.: Rakhajungle, P.S.: Kharagpur, Paschim Medinipore	Path
121	Shyamala Clinical Laboratory	Rakhajangle, P.S.: Kharagpur, West Midnapore	Path
122	Singha Medical Lab.	Hoomgarh, P.S.: Goaltore, Midnapore	Path
123	Sinha Diagnostic Center	Bidhannagar, P.O.: Midnapore, West Midnapore	Path
124	Sonex Diagnostic Center	Post Office Road, P.S.Kotwali, Midnapore, Midnapore(W)	Path
125	Sonex P.C.T.	P.O.& P.S.: Keshpur, Midnapur (W)	Path
126	Spandan Diagnostic & Research Center (P) Ltd.	Rabindranagar, P.O.: Midnapore, P.S.: Kotwali, West Midnapore	Path
127	Sree Ma Diagnostic Center	Chaktarini, P.O. & P.S.: Salboni, West Midnapore	Path
128	Sri Aurobindo X-Ray & Path Lab	Keshiary (Near High School), West Midnapore	Path, X-Ray
129	Sridurga X-Ray & Pathology Center	P.O. & P.S.: Narayangarh, West Midnapore	Path
130	Srikrishna Path Lab.	Chandrakona, P.O.: Satbankura, P.S.: Garbeta, Midnapore (W)	Path
131	Srimaa Pathological Lab.	P.O.: Tapsia, P.S: Beliabera, Midnapore (W)	Path
132	Stain Pathological Laboratory	Raghunathpur, Jhargram, West Midnapore	Path

LIST OF DIAGNOSTIC CENTRES BY DISTRICT

Sl. No	Name of the Units.	Address	Services Catered
133	Subhadeep Path Lab.	P.O.: Silda, P.S.: Binpur, Midnapur (W)	Path
134	Subham Computerised Diagnostic Laboratory & X-Ray Clinic	Gokulchak, P.O.: Jalchak, P.S.: Pingla, Midnapore (W)	Path, X-Ray
135	Subheccha Diagnostic Center	C/o. Sabyasachi Paul, Nabinabag (Mirbazar), P.O.: Midnapur, Paschim Medinipur	Path
136	Sukla Diagnostic Center	Mayapur (DVC), P.O.: Kharagpur, West Midnapore	Path
137	Sumi Diagnostic Centre	Rabindranagar, P.O.: Midnapore, P.S.: Kotwali, West Midnapore	Path
138	Suraksha Diagnostic & Medical Center	P.O.: Jotekanuramgarh, P.S.: Daspur, Midnapur (W)	Path
139	Suraksha Diagnostic & Medical Center	Rabindranagar, P.O.: Midnapore, P.S.: Kotwali, West Midnapore	Path
140	Sustha Diagnostic Center	Sahid Khudiram Basu Road, P.O.: Rajabazar, P.S.: Kotwali, Paschim Medinipore	Path
141	Suswasthya Polyclinic & Diagnostic Center	Inda North, Kamalacabin, Kharagpur, Midnapur (W)	Path
142	Swasti Diagnostic Center	Kushputa, Ghatal, west Midnapore	Path
143	Swasti Diagnostic Center	Garbeta Station, Radhanagar, P.O.: Amlagora, West Midnapore	Path
144	Swasti X-Ray Clinic & Diagnostic Center	Kushputa, Ghatal, West Midnapore	Path
145	The Anubikshan (Pathological Laboratory)	Manikpara, P.O. & P.S.: Jhargram, Paschim Medinipore	Path
146	The Bacto Clinical Lab.	Konnagar, P.O. & P.S.: Ghatal, Midnapore (W)	Path
147	The Health Care Pathological Laboratory	Vill. & P.O. & P.S.: Binpur, Paschim Medinipore	Path
148	The Health Diagnostic Laboratory	Jhargram, Paschim Medinipur	Path
149	Udayan Diagnostic Research Pathological Laboratory	Judge's Court Road, Keranitola, Kotwali, Paschim Medinipore	Path
150	Usha Diagnostic Center	Arora Market ARO 16, Kharagpur, West Midnapore	Path
151	Vidyasagar Instt. Of Health Center for Advancement of Higher Education	P.O.: Rangamati, P.S.: Kotwali, West Midnapore	Path
152	Vision Care	Progati Apartment, Kudiramnagar, Paschim Midnapore	Path
153	Vivekananda Institute of Medical Science (The Millenium Diagnostic Center)	Kushpata, Ghatal, Paschim Medinipore	Path
154	Vivekananda Pathological Lab.	Gobindanagar, P.O.Chenchua Gobindanagar,P.S.:	Path
155	Wood Land Pathological Lab.	Medinipur Town, Paschim Medinipur	Path
Numbers of Path Lab: 151 ; Blood Bank: 0 ; Dental Clinic: 0 ; Forensic Lab: 0 ; Eye Care: 1			

ANNEXURE - III

QUANTIFICATION IN SELECTED HCU_s :

**Report on BMW Generation by category
for 4 consecutive days
and average thereof**

Medical College Hospitals:

R.G.Kar MCH								
Bio-Medical Waste Generated by Category in Kg (Bed Capacity - 1107)								
DAY	Occupancy	Human Anatomical Waste	Microbiology & Bio-technology Waste	Waste Sharps	Discarded Medicine & Cytotoxic Drug	Solid Waste (Soiled)	Solid Waste	Total
		CAT 1	CAT 3	CAT 4	CAT 5	CAT 6	CAT 7	
Day 1	1127	33.450	3.320	16.870	2.380	168.560	95.160	319.740
Day 2	1069	32.450	2.680	15.650	3.860	159.350	90.520	304.510
Day 3	1065	30.400	3.750	17.230	2.750	162.520	87.750	304.400
Day 4	1103	34.090	3.120	17.580	3.650	165.890	92.650	316.980
Total	4364	130.390	12.870	67.330	12.640	656.320	366.080	1245.630
Average per day	1091	32.598	3.218	16.833	3.160	164.080	91.520	311.408
Average per day per bed		0.030	0.003	0.015	0.003	0.150	0.084	0.285
Average per day per bed by %		10.48	1.03	5.41	1.02	52.77	29.43	100

Calcutta National MCH								
Bio-Medical Waste Generated by Category in Kg (Bed Capacity - 1260)								
DAY	Occupancy	Human Anatomical Waste	Microbiology & Bio-technology Waste	Waste Sharps	Discarded Medicine & Cytotoxic Drug	Solid Waste (Soiled)	Solid Waste	Total
		CAT 1	CAT 3	CAT 4	CAT 5	CAT 6	CAT 7	
Day 1*	989	32.320	2.850	17.545	2.740	149.850	78.220	283.525
Day 2	911	27.330	3.540	16.220	2.560	135.850	72.880	258.380
Day 3	941	29.500	1.320	18.560	3.125	142.650	82.460	277.615
Day 4	1034	33.080	3.650	18.980	3.980	155.850	79.850	295.390
Total	3875	122.230	11.360	71.305	12.405	584.200	313.410	1114.910
Average per day	969	30.558	2.840	17.826	3.101	146.050	78.353	278.728
Average per day per bed		0.032	0.003	0.018	0.003	0.151	0.081	0.288
Average per day per bed by %		10.95	1.02	6.39	1.11	52.33	28.08	100

Bardhaman MCH								
Bio-Medical Waste Generated by Category in Kg (Bed Capacity - 1099)								
DAY	Occupancy	Human Anatomical Waste	Microbiology & Bio-technology Waste	Waste Sharps	Discarded Medicine & Cytotoxic Drug	Solid Waste (Soiled)	Solid Waste	Total
		CAT 1	CAT 3	CAT 4	CAT 5	CAT 6	CAT 7	
Day 1	1040	28.520	2.195	15.230	2.650	148.030	82.560	279.185
Day 2	1073	31.850	2.750	15.360	3.625	152.680	85.520	291.785
Day 3	949	24.600	2.320	13.150	2.535	136.850	72.360	251.815
Day 4	987	27.320	2.560	14.890	2.750	139.350	79.000	265.870
Total	4049	112.290	9.825	58.630	11.560	576.910	319.440	1088.655
Average per day	1012	28.073	2.456	14.658	2.890	144.228	79.860	272.164
Average per day per bed		0.028	0.002	0.014	0.003	0.143	0.079	0.269
Average per day per bed by %		10.31	0.90	5.38	1.06	52.98	29.34	100

Bankura Sammilani MCH								
Bio-Medical Waste Generated by Category in Kg (Bed Capacity -1217)								
DAY	Occupancy	Human Anatomical Waste	Microbiology & Bio-technology Waste	Waste Sharps	Discarded Medicine & Cytotoxic Drug	Solid Waste (Soiled)	Solid Waste	Total
		CAT 1	CAT 3	CAT 4	CAT 5	CAT 6	CAT 7	
Day 1	883	26.380	2.850	15.650	2.590	135.800	78.650	261.920
Day 2	884	28.560	3.350	15.800	2.470	137.000	76.250	263.430
Day 3	893	26.980	3.120	15.280	3.460	136.540	76.350	261.730
Day 4	881	27.320	3.110	14.740	2.850	137.250	75.000	260.270
Total	3541	109.240	12.430	61.470	11.370	546.590	306.250	1047.35
Average per day	885	27.310	3.108	15.368	2.843	136.648	76.563	261.838
Average per day per bed		0.031	0.004	0.017	0.003	0.154	0.087	0.296
Average per day per bed by %		10.425	1.186	5.866	1.085	52.163	29.227	100

North Bengal MCH								
Bio-Medical Waste Generated by Category in Kg (Bed Capacity - 1000)								
DAY	Occupancy	Human Anatomical Waste	Microbiology & Bio-technology Waste	Waste Sharps	Discarded Medicine & Cytotoxic Drug	Solid Waste (Soiled)	Solid Waste	Total
		CAT 1	CAT 3	CAT 4	CAT 5	CAT 6	CAT 7	
Day 1	648	13.360	1.925	6.680	2.490	92.750	58.350	175.555
Day 2	643	15.230	2.135	7.580	2.590	91.850	54.780	174.165
Day 3	652	14.650	2.225	7.460	2.410	95.350	52.980	175.075
Day 4	697	13.350	1.960	8.235	2.360	97.850	60.240	183.995
Total	2640	56.590	8.245	29.955	9.850	377.800	226.350	708.790
Average per day	660	14.148	2.061	7.489	2.463	94.450	56.588	177.198
Average per day per bed		0.021	0.003	0.011	0.004	0.143	0.086	0.268
Average per day per bed by %		8.00	1.17	4.23	1.39	53.40	31.99	100

Summary of 5 MCHs

BMW Generation in Medical College Hospitals								
Average Bio-Medical Waste Generated per Day per Bed by Category in Kg								
Names of MCHs	Unit Bed	Human Anatomical Waste	Microbiology & Bio-technology Waste	Waste Sharps	Discarded Medicine & Cytotoxic Drug	Solid Waste (Soiled)	Solid Waste	Total
		CAT 1	CAT 3	CAT 4	CAT 5	CAT 6	CAT 7	
R.G.Kar	1	0.030	0.003	0.015	0.003	0.150	0.084	0.285
National	1	0.032	0.003	0.018	0.003	0.151	0.081	0.288
Bardhaman	1	0.028	0.002	0.014	0.003	0.143	0.079	0.269
Bankura	1	0.031	0.004	0.017	0.003	0.154	0.087	0.296
North Bengal	1	0.021	0.003	0.011	0.004	0.143	0.086	0.268
Total	5	0.141	0.015	0.077	0.016	0.741	0.416	1.406
Average per day per bed		0.028	0.003	0.015	0.003	0.148	0.083	0.281
Average per day per bed by %		10.067	1.063	5.482	1.131	52.750	29.602	100

District Hospitals

Barasat DH								
Bio-Medical Waste Generated by Category in Kg (Bed Capacity - 500)								
DAY	Occupancy	Human Anatomical Waste	Microbiology & Bio-technology Waste	Waste Sharps	Discarded Medicine & Cytotoxic Drug	Solid Waste (Soiled)	Solid Waste	Total
		CAT 1	CAT 3	CAT 4	CAT 5	CAT 6	CAT 7	
Day 1	356	8.190	1.510	5.190	1.330	46.680	26.540	89.440
Day 2	341	9.160	1.640	4.750	1.200	46.230	24.000	86.980
Day 3	290	7.410	0.850	6.520	0.780	38.590	19.040	73.190
Day 4	262	6.820	0.760	3.165	0.860	32.560	17.450	61.615
Total	1249	31.58	4.76	19.625	4.17	164.06	87.03	311.225
Average per day	312	7.895	1.190	4.906	1.043	41.015	21.758	77.806
Average per day per bed		0.025	0.004	0.016	0.003	0.131	0.070	0.249
Average per day per bed by %		10.16	1.53	6.32	1.34	52.79	28.01	100

Siliguri DH								
Bio-Medical Waste Generated by Category in Kg (Bed Capacity - 320)								
DAY	Occupancy	Human Anatomical Waste	Microbiology & Bio-technology Waste	Waste Sharps	Discarded Medicine & Cytotoxic Drug	Solid Waste (Soiled)	Solid Waste	Total
		CAT 1	CAT 3	CAT 4	CAT 5	CAT 6	CAT 7	
Day 1	209	5.225	0.980	3.340	1.220	29.320	16.250	56.335
Day 2	227	6.860	1.250	3.980	0.980	31.540	17.360	61.970
Day 3	203	6.070	1.330	3.960	1.220	29.655	15.350	57.585
Day 4	223	7.360	0.850	4.650	0.860	33.650	15.360	62.730
Total	862	25.515	4.410	15.930	4.280	124.165	64.320	238.620
Average per day	216	6.379	1.103	3.983	1.070	31.041	16.080	59.655
Average per day per bed		0.030	0.005	0.018	0.005	0.144	0.074	0.276
Average per day per bed by %		10.700	1.849	6.680	1.795	52.069	26.973	100

Summary of 2 DHs

BMW Generation in District Hospitals								
Average Bio-Medical Waste Generated per Day by Category in Kg								
Names of DHs	Unit Bed	Human Anatomical Waste	Microbiology & Bio-technology Waste	Waste Sharps	Discarded Medicine & Cytotoxic Drug	Solid Waste (Soiled)	Solid Waste	Total
		CAT 1	CAT 3	CAT 4	CAT 5	CAT 6	CAT 7	
Barasat	1	0.025	0.004	0.016	0.003	0.131	0.070	0.249
Siliguri	1	0.030	0.005	0.018	0.005	0.144	0.074	0.276
Total	2	0.055	0.009	0.034	0.008	0.275	0.144	0.526
Average per day per bed		0.027	0.004	0.017	0.004	0.138	0.072	0.263
Average per day per bed by %		10.425	1.695	6.495	1.577	52.313	27.411	100

Sub-Divisional Hospitals

Bishnupur SDH								
Bio-Medical Waste Generated by Category in Kg (Bed Capacity - 230)								
DAY	Occupancy	Human Anatomical Waste	Microbiology & Bio-technology Waste	Waste Sharps	Discarded Medicine & Cytotoxic Drug	Solid Waste (Soiled)	Solid Waste	Total
		CAT 1	CAT 3	CAT 4	CAT 5	CAT 6	CAT 7	
Day 1	220	4.690	1.130	3.330	1.230	29.320	14.350	54.050
Day 2	221	4.350	1.230	3.850	1.230	30.250	15.250	56.160
Day 3	217	4.550	0.940	3.450	0.980	29.130	13.750	52.800
Day 4	206	4.320	1.200	3.010	1.110	27.200	13.560	50.400
Total	864	17.910	4.500	13.640	4.550	115.900	56.910	213.410
Average per day	216	4.478	1.125	3.410	1.138	28.975	14.228	53.353
Average per day per bed		0.021	0.005	0.016	0.005	0.134	0.066	0.247
Average per day per bed by %		8.39	2.11	6.39	2.13	54.31	26.67	100

Malbazar SDH								
Bio-Medical Waste Generated by Category in Kg (Bed Capacity - 100)								
DAY	Occupancy	Human Anatomical Waste	Microbiology & Bio-technology Waste	Waste Sharps	Discarded Medicine & Cytotoxic Drug	Solid Waste (Soiled)	Solid Waste	Total
		CAT 1	CAT 3	CAT 4	CAT 5	CAT 6	CAT 7	
Day 1	97	1.940	0.750	1.240	0.670	11.360	6.700	22.660
Day 2	111	2.120	0.720	1.960	0.200	15.320	7.560	27.880
Day 3	109	2.150	0.680	1.570	0.560	14.250	6.230	25.440
Day 4	117	2.750	0.560	1.660	0.490	15.860	8.320	29.640
Total	434	8.960	2.710	6.430	1.920	56.790	28.810	105.620
Average per day	109	2.240	0.678	1.608	0.480	14.198	7.203	26.405
Average per day per bed		0.021	0.006	0.015	0.004	0.130	0.066	0.242
Average per day per bed by %		8.49	2.57	6.09	1.82	53.82	27.30	100

Summary of 2 SDHs

BMW Generation in Sub Divisional Hospitals								
Average Bio-Medical Waste Generated per Day per Bed by Category in Kg								
Names of SDHs	Unit Bed	Human Anatomical Waste	Microbiology & Bio-technology Waste	Waste Sharps	Discarded Medicine & Cytotoxic Drug	Solid Waste (Soiled)	Solid Waste	Total
		CAT 1	CAT 3	CAT 4	CAT 5	CAT 6	CAT 7	
Bishnupur	1	0.021	0.005	0.016	0.005	0.134	0.066	0.247
Malbazar	1	0.021	0.006	0.015	0.004	0.130	0.066	0.242
Total	2	0.041	0.011	0.031	0.010	0.264	0.132	0.489
Average per day per bed		0.021	0.006	0.015	0.005	0.132	0.066	0.245
Average per day per bed by %		8.42	2.33	6.23	1.97	53.96	26.93	100

State General Hospitals

Vidyasagar SGH								
Bio-Medical Waste Generated per Day by Category in Kg						(Bed Capacity - 256)		
DAY	Occupancy	Human Anatomical Waste	Microbiology & Bio-technology Waste	Waste Sharps	Discarded Medicine & Cytotoxic Drugs	Solid Waste (Soiled)	Solid Waste	Total
		CAT 1	CAT 3	CAT 4	CAT 5	CAT 6	CAT 7	
Day 1	189	5.670	0.560	3.420	1.860	22.980	12.650	47.140
Day 2	204	7.250	0.740	4.530	1.650	25.950	14.320	54.440
Day 3	186	5.580	0.650	3.230	0.860	23.560	13.250	47.130
Day 4	180	5.830	0.580	2.850	0.910	21.320	12.450	43.940
Total	759	24.330	2.530	14.030	5.280	93.810	52.670	192.650
Average per day	190	6.083	0.633	3.508	1.320	23.453	13.168	48.163
Average per day per bed		0.032	0.003	0.018	0.007	0.123	0.069	0.253
Average per day per bed by %		12.65	1.32	7.30	2.75	48.79	27.39	100

Birpara SGH								
Bio-Medical Waste Generated per Day by Category in Kg						(Bed Capacity - 100)		
DAY	Occupancy	Human Anatomical Waste	Microbiology & Bio-technology Waste	Waste Sharps	Discarded Medicine & Cytotoxic Drugs	Solid Waste (Soiled)	Solid Waste	Total
		CAT 1	CAT 3	CAT 4	CAT 5	CAT 6	CAT 7	
Day 1	101	0.000	0.390	1.810	0.560	12.520	6.780	22.060
Day 2	92	2.760	0.480	1.650	0.270	11.300	6.350	22.810
Day 3	95	2.840	0.260	1.720	0.360	11.380	6.550	23.110
Day 4	102	3.260	0.270	1.950	0.500	12.650	7.050	25.680
Total	390	8.860	1.400	7.130	1.690	47.850	26.730	93.660
Average per day	98	2.215	0.350	1.783	0.423	11.963	6.683	23.415
Average per day per bed		0.023	0.004	0.018	0.004	0.122	0.068	0.239
Average per day per bed by %		9.46	1.49	7.61	1.80	51.07	28.53	100

Summary of 2 SGHs

BMW Generation in State General Hospitals								
Average Bio-Medical Waste Generated per Day per Bed by Category in Kg								
Names of SGHs	Unit Bed	Human Anatomical Waste	Microbiology & Bio-technology Waste	Waste Sharps	Discarded Medicine & Cytotoxic Drug	Solid Waste (Soiled)	Solid Waste	Total
		CAT 1	CAT 3	CAT 4	CAT 5	CAT 6	CAT 7	
Vidyasagar	1	0.032	0.003	0.018	0.007	0.123	0.069	0.253
Birpara	1	0.023	0.004	0.018	0.004	0.122	0.068	0.239
Total	2	0.055	0.007	0.037	0.011	0.246	0.137	0.492
Average per day per bed		0.027	0.003	0.018	0.006	0.123	0.069	0.246
Average per day per bed by %		11.10	1.40	7.45	2.29	49.90	27.95	100

Rural Hospitals

Taldangra RH								
Bio-Medical Waste Generated by Category in Kg (Bed Capacity - 30)								
DAY	Occupancy	Human Anatomical Waste	Microbiology & Bio-technology Waste	Waste Sharps	Discarded Medicine & Cytotoxic Drug	Solid Waste (Soiled)	Solid Waste	Total
		CAT 1	CAT 3	CAT 4	CAT 5	CAT 6	CAT 7	
Day 1	49	1.020	0.120	1.100	0.150	5.680	2.690	10.760
Day 2	49	1.340	0.225	1.230	0.130	4.560	3.720	11.205
Day 3	57	1.150	0.190	1.540	0.300	6.780	3.230	13.190
Day 4	50	1.070	0.180	1.120	0.110	4.390	2.980	9.850
Total	205	4.580	0.715	4.990	0.690	21.410	12.620	45.005
Average per day	51	1.145	0.179	1.248	0.173	5.353	3.155	11.251
Average per day per bed		0.022	0.004	0.024	0.003	0.105	0.062	0.221
Average per day per bed by %		10.16	1.59	11.07	1.53	47.49	27.99	100

Kharibari RH								
Bio-Medical Waste Generated by Category in Kg (Bed Capacity - 30)								
DAY	Occupancy	Human Anatomical Waste	Microbiology & Bio-technology Waste	Waste Sharps	Discarded Medicine & Cytotoxic Drug	Solid Waste (Soiled)	Solid Waste	Total
		CAT 1	CAT 3	CAT 4	CAT 5	CAT 6	CAT 7	
Day 1	16	0.450	0.020	0.410	0.000	1.900	0.900	3.680
Day 2	14	0.120	0.220	0.320	0.410	1.350	1.010	3.430
Day 3	15	0.800	0.000	0.270	0.030	1.780	1.100	3.980
Day 4	13	0.070	0.070	0.320	0.020	1.570	0.900	2.950
Total	58	1.440	0.310	1.320	0.460	6.600	3.910	14.040
Average per day	15	0.360	0.078	0.330	0.115	1.650	0.978	3.510
Average per day per bed		0.024	0.005	0.022	0.008	0.110	0.065	0.234
Average per day per bed by %		10.26	2.21	9.40	3.28	47.01	27.85	100

Summary of 2 RHs

BMW Generation in Rural Hospitals								
Average Bio-Medical Waste Generated per Day per Bed by Category in Kg								
Names of RHs	Unit Bed	Human Anatomical Waste	Microbiology & Bio-technology Waste	Waste Sharps	Discarded Medicine & Cytotoxic Drug	Solid Waste (Soiled)	Solid Waste	Total
		CAT 1	CAT 3	CAT 4	CAT 5	CAT 6	CAT 7	
Taldangra	1	0.022	0.004	0.024	0.003	0.105	0.062	0.221
Kharibari	1	0.024	0.005	0.022	0.008	0.110	0.065	0.234
Total	2	0.046	0.009	0.046	0.011	0.215	0.127	0.455
Average per day per bed		0.023	0.004	0.023	0.006	0.107	0.064	0.227
Average per day per bed by %		10.23	1.91	10.23	2.43	47.35	27.98	100

Block Primary Health Centres

Anchuri BPHC								
Bio-Medical Waste Generated by Category in Kg (Bed Capacity - 10)								
DAY	Occupancy	Human Anatomical Waste	Microbiology & Bio-technology Waste	Waste Sharps	Discarded Medicine & Cytotoxic Drug	Solid Waste (Soiled)	Solid Waste	Total
		CAT 1	CAT 3	CAT 4	CAT 5	CAT 6	CAT 7	
Day 1	13	0.450	0.130	0.310	0.130	1.300	0.640	2.960
Day 2	13	0.000	0.110	0.250	0.060	1.350	0.420	2.190
Day 3	10	0.260	0.090	0.630	0.000	1.160	0.520	2.660
Day 4	13	0.130	0.120	0.220	0.060	1.650	0.360	2.540
Total	49	0.840	0.450	1.410	0.250	5.460	1.940	10.350
Average per day	12	0.210	0.113	0.353	0.063	1.365	0.485	2.588
Average per day per bed		0.018	0.009	0.029	0.005	0.114	0.040	0.216
Average per day per bed by %		8.10	4.34	13.60	2.41	52.66	18.71	100

Matigara BPHC								
Bio-Medical Waste Generated by Category in Kg (Bed Capacity - 10)								
DAY	Occupancy	Human Anatomical Waste	Microbiology & Bio-technology Waste	Waste Sharps	Discarded Medicine & Cytotoxic Drug	Solid Waste (Soiled)	Solid Waste	Total
		CAT 1	CAT 3	CAT 4	CAT 5	CAT 6	CAT 7	
Day 1	9	0.180	0.090	0.220	0.120	1.000	0.450	2.060
Day 2	4	0.000	0.030	0.060	0.070	0.850	0.220	1.230
Day 3	15	0.450	0.190	0.310	0.040	1.520	0.750	3.260
Day 4	15	0.320	0.140	0.430	0.070	1.450	0.590	3.000
Total	43	0.95	0.45	1.02	0.3	4.82	2.01	9.55
Average per day	11	0.238	0.113	0.255	0.075	1.205	0.503	2.388
Average per day per bed		0.022	0.010	0.023	0.007	0.110	0.046	0.217
Average per day per bed by %		9.95	4.71	10.68	3.14	50.48	21.05	100

Summary of 2 BPHCs

BMW Generation in Block Primary Health Centres								
Average Bio-Medical Waste Generated per Day by Category in Kg								
Names of BPHCs	Unit Bed	Human Anatomical Waste	Microbiology & Bio-technology Waste	Waste Sharps	Discarded Medicine & Cytotoxic Drug	Solid Waste (Soiled)	Solid Waste	Total
		CAT 1	CAT 3	CAT 4	CAT 5	CAT 6	CAT 7	
Anchuri	1	0.018	0.009	0.029	0.005	0.114	0.040	0.216
Matigara	1	0.022	0.010	0.023	0.007	0.110	0.046	0.217
Total	2	0.039	0.020	0.053	0.012	0.223	0.086	0.433
Average per day per bed		0.020	0.010	0.026	0.006	0.112	0.043	0.216
Average per day per bed by %		9.05	4.54	12.17	2.78	51.69	19.93	100

Primary Health Centres

Panchmura PHC								
Bio-Medical Waste Generated by Category in Kg (Bed Capacity - 6)								
DAY	Occupancy	Human Anatomical Waste	Microbiology & Bio-technology Waste	Waste Sharps	Discarded Medicine & Cytotoxic Drug	Solid Waste (Soiled)	Solid Waste	Total
		CAT 1	CAT 3	CAT 4	CAT 5	CAT 6	CAT 7	
Day 1	6	0.000	0.000	0.170	0.035	0.650	0.400	1.255
Day 2	5	0.450	0.000	0.160	0.040	0.530	0.230	1.410
Day 3	4	0.000	0.000	0.120	0.040	0.390	0.190	0.740
Day 4	7	0.450	0.000	0.220	0.000	0.530	0.320	1.520
Total	22	0.900	0.000	0.670	0.115	2.100	1.140	4.925
Average per day	6	0.225	0.000	0.168	0.029	0.525	0.285	1.231
Average per day per bed		0.038	0.000	0.028	0.005	0.088	0.048	0.205
Average per day per bed by %		18.29	0.00	13.62	2.34	42.68	23.17	100

Bagdogra PHC								
Bio-Medical Waste Generated by Category in Kg (Bed Capacity - 10)								
DAY	Occupancy	Human Anatomical Waste	Microbiology & Bio-technology Waste	Waste Sharps	Discarded Medicine & Cytotoxic Drug	Solid Waste (Soiled)	Solid Waste	Total
		CAT 1	CAT 3	CAT 4	CAT 5	CAT 6	CAT 7	
Day 1	4	0.000	0.000	0.120	0.080	0.500	0.230	0.930
Day 2	7	0.000	0.000	0.200	0.000	0.630	0.410	1.240
Day 3	9	0.450	0.000	0.180	0.050	0.770	0.450	1.900
Day 4	12	0.450	0.000	0.240	0.090	1.100	0.740	2.620
Total	32	0.900	0.000	0.740	0.220	3.000	1.830	6.690
Average per day	8	0.225	0.000	0.185	0.055	0.750	0.458	1.673
Average per day per bed		0.028	0.000	0.023	0.007	0.094	0.057	0.209
Average per day per bed by %		13.46	0.00	11.06	3.29	44.86	27.36	100

Summary of 2 PHCs

BMW Generation in Primary Health Centres								
Average Bio-Medical Waste Generated per Day by Category in Kg								
Names of PHCs	Unit Bed	Human Anatomical Waste	Microbiology & Bio-technology Waste	Waste Sharps	Discarded Medicine & Cytotoxic Drug	Solid Waste (Soiled)	Solid Waste	Total
		CAT 1	CAT 3	CAT 4	CAT 5	CAT 6	CAT 7	
Anchuri	1	0.038	0.000	0.028	0.005	0.088	0.048	0.205
Matigara	1	0.028	0.000	0.023	0.007	0.094	0.057	0.209
Total	2	0.066	0.000	0.051	0.012	0.181	0.105	0.414
Average per day per bed		0.033	0.000	0.026	0.006	0.091	0.052	0.207
Average per day per bed by %		15.85	0.00	12.33	2.82	43.78	25.29	100

Sub-Centres & Out Reach Sessions

Anchuri Sub-Centre								
Bio-Medical Waste Generated by Category in Kg								
DAY	Patients visited	Human Anatomical Waste	Microbiology & Bio-technology Waste	Waste Sharps	Discarded Medicine & Cytotoxic Drug	Solid Waste (Soiled)	Solid Waste	Total
		CAT 1	CAT 3	CAT 4	CAT 5	CAT 6	CAT 7	
Day 1	24	0.000	0.000	0.120	0.000	0.070	0.620	0.810
Day 2								
Day 3	29	0.000	0.000	0.150	0.000	0.050	0.725	0.925
Day 4								
Total	53	0.000	0.000	0.270	0.000	0.120	1.345	1.735
Average per day	27	0.000	0.000	0.135	0.000	0.060	0.673	0.868
Average per day per patient		0.000	0.000	0.005	0.000	0.002	0.025	0.032
Average per day per patient by %		0.00	0.00	15.63	0.00	6.94	77.84	100

Kharibari Sub-Centre								
Bio-Medical Waste Generated by Category in Kg								
DAY	Patients visited	Human Anatomical Waste	Microbiology & Bio-technology Waste	Waste Sharps	Discarded Medicine & Cytotoxic Drug	Solid Waste (Soiled)	Solid Waste	Total
		CAT 1	CAT 3	CAT 4	CAT 5	CAT 6	CAT 7	
Day 1	18	0.000	0.000	0.050	0.000	0.060	0.450	0.560
Day 2								
Day 3	23	0.000	0.000	0.070	0.000	0.070	0.580	0.720
Day 4								
Total	41	0.000	0.000	0.120	0.000	0.130	1.030	1.280
Average per day	21	0.000	0.000	0.060	0.000	0.065	0.515	0.640
Average per day per patient		0.000	0.000	0.003	0.000	0.003	0.025	0.030
Average per day per patient by %		0.00	0.00	9.52	0.00	10.32	81.75	100

Summary of Sub-Centres & Out Reach Sessions

BMW Generation in Sub-Centres								
Average Bio-Medical Waste Generated per Patient per Day by Category in Kg								
Names of SCs	Unit Patient	Human Anatomical Waste	Microbiology & Bio-technology Waste	Waste Sharps	Discarded Medicine & Cytotoxic Drug	Solid Waste (Soiled)	Solid Waste	Total
		CAT 1	CAT 3	CAT 4	CAT 5	CAT 6	CAT 7	
Anchuri	1	0.000	0.000	0.005	0.000	0.002	0.025	0.032
Kharibari	1	0.000	0.000	0.003	0.000	0.003	0.025	0.030
Total	2	0.000	0.000	0.008	0.000	0.005	0.049	0.063
Average per day per patient		0.000	0.000	0.004	0.000	0.003	0.025	0.032
Average per day per patient by %		0.00	0.00	12.67	0.00	8.58	79.73	100

Municipality HCUs :**Municipality Hospitals**

Dum Dum Municipality Specialised Hospital								
Bio-Medical Waste Generated per Day by Category in Kg (Bed Capacity - 110)								
DAY	Occupancy	Human Anatomical Waste	Microbiology & Bio-technology Waste	Waste Sharps	Discarded Medicine & Cytotoxic Drugs	Solid Waste (Soiled)	Solid Waste	Total
		CAT 1	CAT 3	CAT 4	CAT 5	CAT 6	CAT 7	
Day 1	50	1.460	0.340	1.120	0.240	5.870	3.960	12.990
Day 2	52	1.560	0.260	1.140	0.220	6.500	4.260	13.940
Day 3	44	1.320	0.050	0.960	0.230	5.890	3.860	12.310
Day 4	54	1.620	0.130	1.230	0.230	6.750	4.250	14.210
Total	200	5.960	0.780	4.450	0.920	25.010	16.330	53.450
Average per day	50	1.490	0.195	1.113	0.230	6.253	4.083	13.363
Average per day per bed		0.030	0.004	0.022	0.005	0.125	0.082	0.267
Average per day per bed by %		11.16	1.46	8.33	1.72	46.84	30.58	100

Municipality Hospital, Vivekananda Palli, Malda								
Bio-Medical Waste Generated per Day by Category in Kg (Bed Capacity - 18)								
DAY	Occupancy	Human Anatomical Waste	Microbiology & Bio-technology Waste	Waste Sharps	Discarded Medicine & Cytotoxic Drugs	Solid Waste (Soiled)	Solid Waste	Total
		CAT 1	CAT 3	CAT 4	CAT 5	CAT 6	CAT 7	
Day 1	13	0.900	0.000	0.230	0.040	1.360	0.790	3.320
Day 2	9	0.400	0.000	0.140	0.000	1.120	0.650	2.310
Day 3	12	0.450	0.000	0.230	0.060	1.350	0.940	3.030
Day 4	16	0.450	0.000	0.320	0.060	1.780	1.120	3.730
Total	50	2.200	0.000	0.920	0.160	5.610	3.500	12.390
Average per day	13	0.550	0.000	0.230	0.040	1.403	0.875	3.098
Average per day per bed		0.042	0.000	0.018	0.003	0.108	0.067	0.238
Average per day per bed by %		17.78	0.00	7.43	1.29	45.33	28.28	100

Summary of 2 Municipal Hospitals

BMW Generation in Municipal Hospitals								
Average Bio-Medical Waste Generated per Day by Category in Kg								
Names of Hospitals	Unit Bed	Human Anatomical Waste	Microbiology & Bio-technology Waste	Waste Sharps	Discarded Medicine & Cytotoxic Drug	Solid Waste (Soiled)	Solid Waste	Total
		CAT 1	CAT 3	CAT 4	CAT 5	CAT 6	CAT 7	
Dum Dum	1	0.030	0.004	0.022	0.005	0.125	0.082	0.267
Malda	1	0.042	0.000	0.018	0.003	0.108	0.067	0.238
Total	2	0.072	0.004	0.040	0.008	0.233	0.149	0.506
Average per day per bed		0.036	0.002	0.020	0.004	0.116	0.074	0.253
Average per day per bed by %		14.25	0.77	7.89	1.52	46.03	29.44	100

Municipality Maternity Homes

Balurghat Municipal Hospital and Matri Sadan								
Bio-Medical Waste Generated by Category in Kg (Bed Capacity - 30)								
DAY	Occupancy	Human Anatomical Waste	Microbiology & Bio-technology Waste	Waste Sharps	Discarded Medicine & Cytotoxic Drug	Solid Waste (Soiled)	Solid Waste	Total
		CAT 1	CAT 3	CAT 4	CAT 5	CAT 6	CAT 7	
Day 1	12	1.350	0.000	0.240	0.040	1.600	0.820	4.050
Day 2	13	0.900	0.000	0.320	0.020	1.750	0.900	3.890
Day 3	9	0.450	0.000	0.220	0.000	1.230	0.790	2.690
Day 4	11	0.900	0.000	0.290	0.060	1.320	0.830	3.400
Total	45	3.600	0.000	1.070	0.120	5.900	3.340	14.030
Average per day	11	0.900	0.000	0.268	0.030	1.475	0.835	3.508
Average per day per bed		0.082	0.000	0.024	0.003	0.134	0.076	0.319
Average per day per bed by %		25.65	0.00	7.62	0.85	42.03	23.80	100

Matrisadan, Titagarh Municipality								
Bio-Medical Waste Generated by Category in Kg (Bed Capacity - 12)								
DAY	Occupancy	Human Anatomical Waste	Microbiology & Bio-technology Waste	Waste Sharps	Discarded Medicine & Cytotoxic Drug	Solid Waste (Soiled)	Solid Waste	Total
		CAT 1	CAT 3	CAT 4	CAT 5	CAT 6	CAT 7	
Day 1	5	0.450	0.000	0.160	0.020	0.670	0.380	1.680
Day 2	8	0.450	0.000	0.190	0.030	0.690	0.460	1.820
Day 3	9	0.900	0.000	0.220	0.030	0.720	0.460	2.330
Day 4	6	0.450	0.000	0.120	0.000	0.560	0.220	1.350
Total	28	2.250	0.000	0.690	0.080	2.640	1.520	7.180
Average per day	7	0.563	0.000	0.173	0.020	0.660	0.380	1.795
Average per day per bed		0.080	0.000	0.025	0.003	0.094	0.054	0.256
Average per day per bed by %		31.39	0.00	9.63	1.12	36.83	21.21	100

Summary of 2 Municipal Maternity Homes

BMW Generation in Municipality Maternity Homes								
Bio-Medical Waste Generated by Category in Kg (Bed Capacity - 30)								
Names of Matri Sadans	Unit Bed	Human Anatomical Waste	Microbiology & Bio-technology Waste	Waste Sharps	Discarded Medicine & Cytotoxic Drug	Solid Waste (Soiled)	Solid Waste	Total
		CAT 1	CAT 3	CAT 4	CAT 5	CAT 6	CAT 7	
Balurghat	1	0.082	0.000	0.024	0.003	0.134	0.076	0.319
Titagarh	1	0.080	0.000	0.025	0.003	0.094	0.054	0.256
Total	2	0.162	0.000	0.049	0.006	0.228	0.130	0.575
Average per day per bed		0.081	0.000	0.024	0.003	0.114	0.065	0.288
Average per day per bed by %		28.16	0.00	8.50	0.97	39.65	22.60	100

Municipal ESOPDs

Dum Dum Municipality ESOPD								
Bio-Medical Waste Generated by Category in Kg								
DAY	No. of Patients	Human Anatomical Waste	Microbiology & Bio-technology Waste	Waste Sharps	Discarded Medicine & Cytotoxic Drug	Solid Waste (Soiled)	Solid Waste	Total
		CAT 1	CAT 3	CAT 4	CAT 5	CAT 6	CAT 7	
Day 1	156	0.000	0.000	0.780	0.000	0.490	2.240	3.510
Day 2	144	0.000	0.000	0.620	0.000	0.290	2.760	3.670
Day 3	120	0.000	0.000	0.560	0.000	0.570	2.230	3.360
Day 4	180	0.000	0.000	0.980	0.000	0.670	2.130	3.780
Total	600	0.000	0.000	2.940	0.000	2.020	9.360	14.320
Average per day	150	0.000	0.000	0.735	0.000	0.505	2.340	3.580
Average per day per patient		0.000	0.000	0.005	0.000	0.003	0.016	0.024
Average per day per patient by %		0.00	0.00	20.42	0.00	14.03	65.00	100

English Bazar Municipality ESOPD								
Bio-Medical Waste Generated by Category in Kg								
DAY	No. of Patients	Human Anatomical Waste	Microbiology & Bio-technology Waste	Waste Sharps	Discarded Medicine & Cytotoxic Drug	Solid Waste (Soiled)	Solid Waste	Total
		CAT 1	CAT 3	CAT 4	CAT 5	CAT 6	CAT 7	
Day 1	32	0.000	0.000	0.150	0.000	0.110	0.540	0.800
Day 2	35	0.000	0.000	0.170	0.000	0.130	0.450	0.750
Day 3	21	0.000	0.000	0.110	0.000	0.090	0.380	0.580
Day 4	32	0.000	0.000	0.210	0.000	0.160	0.450	0.820
Total	120	0.000	0.000	0.640	0.000	0.490	1.820	2.950
Average per day	30	0.000	0.000	0.160	0.000	0.123	0.455	0.738
Average per day per patient		0.000	0.000	0.005	0.000	0.004	0.015	0.025
Average per day per patient by %		0.00	0.00	21.33	0.00	16.33	60.67	100

Summary of Municipal ESOPDs

BMW Generation in Municipality ESOPDs								
Bio-Medical Waste Generated by Category in Kg								
Names of Immunisation Centres	Unit Patient per Day	Human Anatomical Waste	Microbiology & Bio-technology Waste	Waste Sharps	Discarded Medicine & Cytotoxic Drug	Solid Waste (Soiled)	Solid Waste	Total
		CAT 1	CAT 3	CAT 4	CAT 5	CAT 6	CAT 7	
Dum Dum	1	0.000	0.000	0.005	0.000	0.003	0.016	0.024
English Bazar	1	0.000	0.000	0.005	0.000	0.004	0.015	0.025
Total	2	0.000	0.000	0.010	0.000	0.007	0.031	0.048
Average per day per patient		0.000	0.000	0.005	0.000	0.004	0.015	0.024
Average per day per patient by %		0.00	0.00	21.32	0.00	15.52	64.10	100

Municipal Sub-Centres

Balurghat Municipality Sub-Centre								
Bio-Medical Waste Generated by Category in Kg								
DAY	No. of Patients	Human Anatomical Waste	Microbiology & Bio-technology Waste	Waste Sharps	Discarded Medicine & Cytotoxic Drug	Solid Waste (Soiled)	Solid Waste	Total
		CAT 1	CAT 3	CAT 4	CAT 5	CAT 6	CAT 7	
Day 1	22	0.000	0.000	0.120	0.000	0.090	0.550	0.760
Day 2	19	0.000	0.000	0.090	0.000	0.080	0.430	0.600
Day 3	13	0.000	0.000	0.060	0.000	0.070	0.300	0.430
Day 4	25	0.000	0.000	0.130	0.000	0.100	0.260	0.490
Total	79	0.000	0.000	0.400	0.000	0.340	1.540	2.280
Average per day	20	0.000	0.000	0.100	0.000	0.085	0.385	0.570
Average per day per patient		0.000	0.000	0.005	0.000	0.004	0.019	0.029
Average per day per patient by %		0.00	0.00	17.24	0.00	14.66	66.38	100

Titagarh Municipality Sub-Centre								
Bio-Medical Waste Generated by Category in Kg								
DAY	No. of Patients	Human Anatomical Waste	Microbiology & Bio-technology Waste	Waste Sharps	Discarded Medicine & Cytotoxic Drug	Solid Waste (Soiled)	Solid Waste	Total
		CAT 1	CAT 3	CAT 4	CAT 5	CAT 6	CAT 7	
Day 1	33	0.000	0.000	0.170	0.000	0.180	0.820	1.170
Day 2	27	0.000	0.000	0.130	0.000	0.150	0.680	0.960
Day 3	23	0.000	0.000	0.110	0.000	0.130	0.550	0.790
Day 4	32	0.000	0.000	0.150	0.000	0.170	0.760	1.080
Total	115	0.000	0.000	0.560	0.000	0.630	2.810	4.000
Average per day	29	0.000	0.000	0.140	0.000	0.158	0.703	1.000
Average per day per patient		0.000	0.000	0.005	0.000	0.005	0.024	0.034
Average per day per patient by %		0.00	0.00	14.20	0.00	15.97	71.25	100

Summary of Municipal Sub-Centres

BMW Generation in Municipality Sub-Centres								
Bio-Medical Waste Generated by Category in Kg								
Names of Immunization Centres	Unit Patient per Day	Human Anatomical Waste	Microbiology & Bio-technology Waste	Waste Sharps	Discarded Medicine & Cytotoxic Drug	Solid Waste (Soiled)	Solid Waste	Total
		CAT 1	CAT 3	CAT 4	CAT 5	CAT 6	CAT 7	
Balurghat	1	0.000	0.000	0.005	0.000	0.004	0.019	0.029
Titagarh	1	0.000	0.000	0.005	0.000	0.005	0.024	0.034
Total	2	0.000	0.000	0.010	0.000	0.010	0.043	0.063
Average per day per patient		0.000	0.000	0.005	0.000	0.005	0.022	0.031
Average per day per patient by %		0.00	0.00	15.85	0.00	15.61	70.12	100

Private Hospitals:

AMRI (Very Large)								
Bio-Medical Waste Generated per Day by Category in Kg (Bed Capacity - 380)								
DAY	Occupancy	Human Anatomical Waste	Microbiology & Bio-technology Waste	Waste Sharps	Discarded Medicine & Cytotoxic Drug	Solid Waste (Soiled)	Solid Waste	Total
		CAT 1	CAT 3	CAT 4	CAT 5	CAT 6	CAT 7	
Day 1	327	10.850	3.520	9.650	1.320	71.980	69.230	166.550
Day 2	334	12.580	2.950	15.450	2.650	80.480	75.520	189.630
Day 3	330	13.850	4.250	10.950	2.350	73.520	79.800	184.720
Day 4	319	9.350	2.420	9.250	6.350	68.520	74.360	170.250
Total	1310	46.630	13.140	45.300	12.670	294.500	298.910	711.150
Average per day	328	11.658	3.285	11.325	3.168	73.625	74.728	177.788
Average per day per bed		0.036	0.010	0.035	0.010	0.224	0.228	0.542
Average per day per bed by %		6.557	1.848	6.370	1.782	41.414	42.035	100

Woodlands (Large)								
Bio-Medical Waste Generated per Day by Category in Kg (Bed Capacity - 230)								
DAY	Occupancy	Human Anatomical Waste	Microbiology & Bio-technology Waste	Waste Sharps	Discarded Medicine & Cytotoxic Drug	Solid Waste (Soiled)	Solid Waste	Total
		CAT 1	CAT 3	CAT 4	CAT 5	CAT 6	CAT 7	
Day 1	119	3.980	1.750	4.850	1.410	24.990	27.370	64.350
Day 2	124	4.120	2.100	5.420	1.550	25.900	28.360	67.450
Day 3	159	6.420	1.650	6.300	2.350	33.390	30.250	80.360
Day 4	124	4.360	1.250	3.950	1.650	25.240	27.650	64.100
Total	526	18.880	6.750	20.520	6.960	109.520	113.630	276.260
Average per day	132	4.720	1.688	5.130	1.740	27.380	28.408	69.065
Average per day per bed		0.036	0.013	0.039	0.013	0.207	0.215	0.523
Average per day per bed by %		6.84	2.44	7.43	2.52	39.66	41.15	100

Institute of Child Health (Medium)								
Bio-Medical Waste Generated per Day by Category in Kg (Bed Capacity - 85)								
DAY	Occupancy	Human Anatomical Waste	Microbiology & Bio-technology Waste	Waste Sharps	Discarded Medicine & Cytotoxic Drug	Solid Waste (Soiled)	Solid Waste	Total
		CAT 1	CAT 3	CAT 4	CAT 5	CAT 6	CAT 7	
Day 1	90	1.900	1.800	2.080	0.550	14.580	12.580	33.490
Day 2	88	2.340	0.450	1.930	0.750	16.520	13.850	35.840
Day 3	91	1.850	0.980	1.850	0.460	13.750	9.850	28.740
Day 4	93	2.410	0.360	2.570	0.670	14.250	16.540	36.800
Total	362	8.500	3.590	8.430	2.430	59.100	52.820	134.870
Average per day	91	2.125	0.898	2.108	0.608	14.775	13.205	33.718
Average per day per bed		0.023	0.010	0.023	0.007	0.162	0.145	0.371
Average per day per bed by %		6.29	2.66	6.24	1.80	43.76	39.11	100

Dr. M.C.N. Nursing Home (Small)								
Bio-Medical Waste Generated per Day by Category in Kg (Bed Capacity - 10)								
DAY	Occupancy	Human Anatomical Waste	Microbiology & Bio-technology Waste	Waste Sharps	Discarded Medicine & Cytotoxic Drug	Solid Waste (Soiled)	Solid Waste	Total
		CAT 1	CAT 3	CAT 4	CAT 5	CAT 6	CAT 7	
Day 1	10	0.500	0.000	0.250	0.070	1.320	1.210	3.350
Day 2	8	0.000	0.000	0.180	0.070	1.300	0.750	2.300
Day 3	7	0.450	0.000	0.240	0.000	0.950	0.870	2.510
Day 4	10	0.200	0.000	0.210	0.070	1.330	1.250	3.060
Total	35	1.150	0.000	0.880	0.210	4.900	4.080	11.220
Average per day	9	0.288	0.000	0.220	0.053	1.225	1.020	2.805
Average per day per bed		0.032	0.000	0.024	0.006	0.136	0.113	0.312
Average per day per bed by %		10.24	0.00	7.83	1.87	43.63	36.32	100

Specialty Hospitals :

Society for Direct Initiative for Social & Health Action (DISHA)

Chittaranjan National Cancer Institute								
Bio-Medical Waste Generated per Day by Category in Kg (Bed Capacity - 200)								
DAY	Occupancy	Human Anatomical Waste	Microbiology & Bio-technology Waste	Waste Sharps	Discarded Medicine & Cytotoxic Drug	Solid Waste (Soiled)	Solid Waste	Total
		CAT 1	CAT 3	CAT 4	CAT 5	CAT 6	CAT 7	
Day 1	164	0.350	0.580	3.850	0.340	22.560	12.900	40.580
Day 2	182	0.860	0.860	5.380	0.280	24.850	12.670	44.900
Day 3	187	0.670	0.560	4.850	0.260	25.560	11.870	43.770
Day 4	189	1.120	0.750	5.380	0.450	25.160	11.360	44.220
Total	722	3.000	2.750	19.460	1.330	98.130	48.800	173.470
Average per day	181	0.750	0.688	4.865	0.333	24.533	12.200	43.368
Average per day per bed		0.004	0.004	0.027	0.002	0.136	0.067	0.240
Average per day per bed by %		1.73	1.58	11.20	0.77	56.47	28.08	100

ID & BG Hospital & Research Centre								
Bio-Medical Waste Generated per Day by Category in Kg (Bed Capacity - 780)								
DAY	Occupancy	Human Anatomical Waste	Microbiology & Bio-technology Waste	Waste Sharps	Discarded Medicine & Cytotoxic Drug	Solid Waste (Soiled)	Solid Waste	Total
		CAT 1	CAT 3	CAT 4	CAT 5	CAT 6	CAT 7	
Day 1	199	0.000	0.890	3.690	0.950	26.980	15.670	48.180
Day 2	207	0.000	1.150	4.650	1.450	25.670	17.850	50.770
Day 3	197	0.000	1.890	3.980	1.160	23.980	13.980	44.990
Day 4	210	0.000	1.400	4.870	0.960	24.540	15.560	47.330
Total	813	0.000	5.330	17.190	4.520	101.170	63.060	191.270
Average per day	203	0.000	1.333	4.298	1.130	25.293	15.765	47.818
Average per day per bed		0.000	0.007	0.021	0.006	0.125	0.078	0.236
Average per day per bed by %		0.00	2.78	8.97	2.36	52.79	32.91	100

K. S. Roy TB Hospital								
Bio-Medical Waste Generated per Day by Category in Kg (Bed Capacity - 350)								
DAY	Occupancy	Human Anatomical Waste	Microbiology & Bio-technology Waste	Waste Sharps	Discarded Medicine & Cytotoxic Drug	Solid Waste (Soiled)	Solid Waste	Total
		CAT 1	CAT 3	CAT 4	CAT 5	CAT 6	CAT 7	
Day 1	100	0.000	0.540	2.270	0.430	10.980	5.540	19.760
Day 2	100	0.000	0.630	1.870	0.560	10.850	5.000	18.910
Day 3	101	0.000	0.530	1.840	0.750	8.990	4.780	16.890
Day 4	103	0.000	0.580	2.110	0.520	10.340	4.870	18.420
Total	404	0.000	2.280	8.090	2.260	41.160	20.190	73.980
Average per day	101	0.000	0.570	2.023	0.565	10.290	5.048	18.495
Average per day per bed		0.000	0.006	0.020	0.006	0.102	0.050	0.183
Average per day per bed by %		0.00	3.08	10.94	3.06	55.67	27.31	100

Premananda Memorial Leprosy Hospital								
Bio-Medical Waste Generated per Day by Category in Kg (Bed Capacity - 70)								
DAY	Occupancy	Human Anatomical Waste	Microbiology & Bio-technology Waste	Waste Sharps	Discarded Medicine & Cytotoxic Drug	Solid Waste (Soiled)	Solid Waste	Total
		CAT 1	CAT 3	CAT 4	CAT 5	CAT 6	CAT 7	
Day 1	70	0.540	0.490	1.120	0.420	8.750	5.460	16.780
Day 2	69	0.320	0.740	1.050	0.390	9.320	5.120	16.940
Day 3	70	0.550	0.370	0.980	0.540	7.720	4.650	14.810
Day 4	70	0.490	0.570	1.320	0.470	8.750	5.500	17.100
Total	279	1.900	2.170	4.470	1.820	34.540	20.730	65.630
Average per day	70	0.475	0.543	1.118	0.455	8.635	5.183	16.408
Average per day per bed		0.007	0.008	0.016	0.007	0.123	0.074	0.234
Average per day per bed by %		2.90	3.31	6.82	2.78	52.72	31.64	100

DISHA Eye Hospital and Research Centre								
Bio-Medical Waste Generated per Day by Category in Kg (Bed Capacity - 115 / Day Care)								
DAY	Surgery and Other Treatments	Human Anatomical Waste	Microbiology & Bio-technology Waste	Waste Sharps	Discarded Medicine & Cytotoxic Drug	Solid Waste (Soiled)	Solid Waste	Total
		CAT 1	CAT 3	CAT 4	CAT 5	CAT 6	CAT 7	
Day 1	118	0.000	0.160	1.750	0.550	2.800	2.260	7.520
Day 2	118	0.000	0.190	1.860	0.450	2.780	2.870	8.150
Day 3	147	0.000	0.290	2.205	1.040	3.450	3.850	10.835
Day 4	131	0.000	0.240	2.160	0.750	2.970	3.240	9.360
Total	514	0.000	0.880	7.975	2.790	12.000	12.220	35.865
Average per day	129	0.000	0.220	1.994	0.698	3.000	3.055	8.966
Average per day per patient		0.000	0.002	0.015	0.005	0.023	0.024	0.070
Average per day per patient by %		0.00	2.44	22.08	7.72	33.22	33.83	100

R. Ahmed Dental College & Hospital								
Bio-Medical Waste Generated per Day by Category in Kg (Bed Capacity - 100 Sits / Day Care)								
DAY	Surgery and Other Treatments	Human Anatomical Waste	Microbiology & Bio-technology Waste	Waste Sharps	Discarded Medicine & Cytotoxic Drug	Solid Waste (Soiled)	Solid Waste	Total
		CAT 1	CAT 3	CAT 4	CAT 5	CAT 6	CAT 7	
Day 1	161	0.540	0.520	0.570	0.060	2.350	3.320	7.360
Day 2	225	0.720	0.390	0.490	0.070	2.650	3.680	8.000
Day 3	219	0.850	0.390	0.860	0.100	1.960	3.910	8.070
Day 4	200	0.760	0.250	0.630	0.150	2.610	3.780	8.180
Total	805	2.870	1.550	2.550	0.380	9.570	14.690	31.610
Average per day	201	0.718	0.388	0.638	0.095	2.393	3.673	7.903
Average per day per patient		0.004	0.002	0.003	0.000	0.012	0.018	0.039
Average per day per patient by %		9.15	4.94	8.13	1.21	30.52	46.85	100

Institute of Animal Health and Veterinary Biologicals								
Bio-Medical Waste Generated per Day by Category in Kg								
DAY	Surgery and Other Treatments	Animal Waste	Microbiology & Bio-technology Waste	Waste Sharps	Discarded Medicine & Cytotoxic Drug	Solid Waste (Soiled)	Solid Waste	Total
		CAT 2	CAT 3	CAT 4	CAT 5	CAT 6	CAT 7	
Day 1	52	0.090	0.270	0.180	0.120	1.650	2.370	4.680
Day 2	46	0.040	0.340	0.260	0.130	2.120	3.130	6.020
Day 3	49	0.080	0.230	0.190	0.260	1.330	2.450	4.540
Day 4	56	0.060	0.150	0.330	0.230	1.700	2.870	5.340
Total	203	0.270	0.990	0.960	0.740	6.800	10.820	20.580
Average per day	51	0.068	0.248	0.240	0.185	1.700	2.705	5.145
Average per patient per day		0.001	0.005	0.005	0.004	0.033	0.053	0.101
Average per patient per day by %		1.31	4.80	4.66	3.59	33.00	52.51	100

Pathological Laboratories: Large Pathological Laboratory

Drs. Tribedi & Roy Diagnostic Laboratory								
Bio-Medical Waste Generated by Category in Kg								
DAY	No. of Samples Collected	Human Anatomical Waste	Microbiology & Bio-technology Waste	Waste Sharps	Discarded Medicine & Cytotoxic Drug	Solid Waste (Soiled)	Solid Waste	Total
		CAT 1	CAT 3	CAT 4	CAT 5	CAT 6	CAT 7	
Day 1	972	0.000	10.200	3.410	0.000	3.680	16.230	33.520
Day 2	905	0.000	9.210	4.760	0.000	3.450	17.630	35.050
Day 3	1030	0.000	11.870	4.570	0.000	4.560	23.980	44.980
Day 4	932	0.000	9.540	1.950	0.000	3.540	13.650	28.680
Total	3839	0.000	40.820	14.690	0.000	15.230	71.490	142.230
Average per day	960	4.800	5.760	3.673	0.000	3.808	17.873	35.558
Average per day per sample		0.005	0.006	0.004	0.000	0.004	0.019	0.037
Average per day by %		0.00	28.73	10.34	0.00	10.72	50.32	100

Medium Pathological Laboratory

Narendra Seva Trust								
Bio-Medical Waste Generated by Category in Kg								
DAY	No. of Samples Collected	Human Anatomical Waste	Microbiology & Bio-technology Waste	Waste Sharps	Discarded Medicine & Cytotoxic Drug	Solid Waste (Soiled)	Solid Waste	Total
		CAT 1	CAT 3	CAT 4	CAT 5	CAT 6	CAT 7	
Day 1	68	0.000	0.444	0.188	0.000	0.119	1.269	2.020
Day 2	55	0.000	0.359	0.152	0.000	0.096	1.026	1.634
Day 3	69	0.000	0.450	0.191	0.000	0.121	1.287	2.049
Day 4	64	0.000	0.418	0.177	0.000	0.112	1.194	1.901
Total	256	0.000	1.671	0.708	0.000	0.449	4.776	7.604
Average per day	64	0.000	0.418	0.177	0.000	0.112	1.194	1.901
Average per day per sample		0.000	0.007	0.003	0.000	0.002	0.019	0.030
Average per day by %		0.00	21.76	9.22	0.00	5.84	62.19	100.00

Small Pathological Laboratory

Ramkrishna Pathological Laboratory, Coochbihar								
Bio-Medical Waste Generated by Category in Kg								
DAY	No. of Samples Collected	Human Anatomical Waste	Microbiology & Bio-technology Waste	Waste Sharps	Discarded Medicine & Cytotoxic Drug	Solid Waste (Soiled)	Solid Waste	Total
		CAT 1	CAT 3	CAT 4	CAT 5	CAT 6	CAT 7	
Day 1	33	0.000	0.190	0.100	0.000	0.070	0.730	1.090
Day 2	46	0.000	0.280	0.160	0.000	0.090	0.910	1.440
Day 3	27	0.000	0.150	0.090	0.000	0.060	0.610	0.910
Day 4	35	0.000	0.210	0.110	0.000	0.070	0.430	0.820
Total	141	0.000	0.830	0.460	0.000	0.290	2.680	4.260
Average per day	35	0.000	0.208	0.115	0.000	0.073	0.670	1.065
Average per day per sample		0.000	0.006	0.003	0.000	0.002	0.019	0.030
Average per day by %		0.000	19.762	10.952	0.000	6.905	63.810	100

ANNEXURE - IV
QUANTIFICATION SUMMARY

Report on total BMW Generation by category
In West Bengal

BMW Generation in Bankura District (Weight in Kg)										
A. Bedded Facilities										
Health Care Unit (HCU) Categories	No. of Units	Total Bed Strength	Frequency - Days in a Year*	CAT 1	CAT 3	CAT 4	CAT 5	CAT 6	CAT 7	Total Generation in a Year
Government										
MCH	1	1217	365	12566.349	1327.419	6842.511	1412.176	65843.960	36949.723	124942.138
DH			365							
SDH	2	245	365	1845.715	510.792	1365.285	432.364	11821.798	5899.637	21875.592
SGH [Dedicated for Leprosy]	**1	**550	365							
RH	6	210	365	1780.234	332.338	1780.610	423.454	8237.996	4868.402	17423.033
BPHC	17	326	365	2325.714	1166.237	3126.868	715.518	13284.963	5122.429	25741.729
PHC	70	386	365	4622.953		3595.630	821.858	12768.156	7374.711	29183.309
Other Government										
< 50 Beds (BPHC)	3	27	365	192.620	96.590	258.974	59.261	1100.288	424.250	2131.984
50 - 100 Beds (RH)	1	50	365	423.865	79.128	423.955	100.822	1961.428	1159.143	4148.341
> 101 - 300 Beds (SGH)			365							
> 300 Beds (DH)			365							
Private										
Small (< 50 Beds)	46	470	365	5480.069		4193.444	1000.708	23349.861	19442.333	53466.417
Medium (50 - 100 Beds)			365							
Large (101 - 300 Beds)	1	120	365	1566.182	311.080	1702.227	494.409	8977.341	9840.898	22892.136
Very Large (> 300 Beds)			365							
Municipality										
Hospital	0		365							
Maternity Homes	0		365							
Specialty Hospitals										
Eye*	1	5	300		2.558	23.183	8.110	34.884	35.523	104.259
Dental*			300							
Infectious Disease			365							
Leprosy	2	718	365	1778.332	2031.043	4183.760	1703.455	32328.206	19402.540	61427.336
Cancer			365							
TB			365							
A. Bedded Gr. Total	150	3774		32582.034	5857.185	27496.447	7172.136	179708.881	110519.590	363336.273

* Eye and Dental Hospitals are closed on Sundays and some holidays. ** Included in Specialty Hospital - Leprosy Row

BMW Generation in Bankura District (Weight in Kg)										
B. Non-Bedded Facilities										
Health Care Unit (HCU) Categories	No. of Units	Average No. of Immunization	Frequency - Days in a Year*	CAT 1	CAT 3	CAT 4	CAT 5	CAT 6	CAT 7	Total Generation in a Year
Government										
Rural	564	30	50			3323.571		2249.286	20909.405	26482.262
Urban	24	30	50			149.362		95.745	909.574	1154.681
Municipality										
ESOPD	0	30	300							
Sub Centres	12	50	104			306.621		302.048	1356.393	1965.062
B. Non-Bedded Gr. Total						3779.554		2647.079	23175.372	29602.005
* Clinical activities held in Govt. Sub Centres average 50 per year and Municipal Immunisation Centres twice in a week. Municipal Clinics are closed on Sundays and some holidays.										

BMW Generation in Bankura District (Weight in Kg)										
C. Pathological Laboratories										
Health Care Unit (HCU) Categories	No. of Units	Average No. of Tests / Month	No. of Months in a Year	CAT 1	CAT 3	CAT 4	CAT 5	CAT 6	CAT 7	Total Generation in a Year
Large		2000	12							
Medium	14	500	12		563.902	239.016		151.377	1612.033	2566.328
Small	58	250	12		1024.457	567.771		357.943	3307.886	5258.057
C. Path Lab Gr. Total	72				1588.359	806.788		509.320	4919.919	7824.385

Annual BMW Generation in Bankura District							
(Rounded off to Kg)							
Categories	CAT 1	CAT 3	CAT 4	CAT 5	CAT 6	CAT 7	Total BMW
A. Bedded Facilities	32582	5857	27496	7172	179709	110520	363336
B. Non-Bedded Facilities			3780		2647	23175	29602
C. Pathological Centres		1588	807		509	4920	7824
Total	32582	7446	32083	7172	182865	138615	400763

BMW Generation in Birbhum District (Weight in Kg)										
A. Bedded Facilities										
Health Care Unit (HCU) Categories	No. of Units	Total Bed Strength	Frequency - Days in a Year*	CAT 1	CAT 3	CAT 4	CAT 5	CAT 6	CAT 7	Total Generation in a Year
Government										
MCH			365							
DH	1	500	365	5003.761	813.792	3117.343	756.923	25109.064	13156.427	47957.310
SDH	2	411	365	3096.282	856.880	2290.335	725.313	19831.669	9896.942	36697.421
SGH			365							
RH	4	170	365	1441.142	269.035	1441.446	342.796	6668.854	3941.088	14104.360
BPHC	15	310	365	2211.568	1108.999	2973.402	680.400	12632.940	4871.022	24478.331
PHC	58	346	365	4143.891		3223.026	736.692	11445.031	6610.492	26159.132
Other Government										
< 50 Beds (BPHC)	4	34	365	242.559	121.632	326.115	74.625	1385.548	534.241	2684.720
50 - 100 Beds (RH)	1	50	365	423.865	79.128	423.955	100.822	1961.428	1159.143	4148.341
> 101 - 300 Beds (SGH)			365							
> 300 Beds (DH)			365							
Private										
Small (< 50 Beds)	43	405	365	4722.188		3613.500	862.313	20120.625	16753.500	46072.125
Medium (50 - 100 Beds)			365							
Large (101 - 300 Beds)			365							
Very Large (> 300 Beds)			365							
Municipality										
Hospital	0		365							
Maternity Homes	0		365							
Specialty Hospitals										
Eye*	5	41	300		20.977	190.102	66.506	286.047	291.291	854.922
Dental*			300							
Infectious Disease			365							
Leprosy			365							
Cancer			365							
TB	1	300	365		617.970	2192.710	612.550	11155.990	5472.290	20051.510
A. Bedded Gr. Total	134	2567		21285.255	3888.414	19791.933	4958.939	110597.196	62686.436	223208.172
* Eye and Dental Hospitals are closed on Sundays and some holidays.										

BMW Generation in Birbhum District (Weight in Kg)										
B. Non-Bedded Facilities										
Health Care Unit (HCU) Categories	No. of Units	Average No. of Patients	Frequency - Days in a Year*	CAT 1	CAT 3	CAT 4	CAT 5	CAT 6	CAT 7	Total Generation in a Year
Government										
Rural	484	30	50			2852.143		1930.238	17943.532	22725.913
Urban	26	30	50			161.809		103.723	985.372	1250.904
Municipality										
ESOPD	0	30	300							
Sub Centres	22	50	104			562.138		553.755	2486.721	3602.614
B. Non-Bedded Gr. Total						3576.089		2587.717	21415.625	27579.431
* Clinical activities held in Govt. Sub Centres average 50 per year and Municipal Immunisation Centres twice in a week. Municipal Clinics are closed on Sundays and some holidays.										

BMW Generation in Birbhum District (Weight in Kg)										
C. Pathological Laboratories										
Health Care Unit (HCU) Categories	No. of Units	Average No. of Tests / Month	No. of Months in a Year	CAT 1	CAT 3	CAT 4	CAT 5	CAT 6	CAT 7	Total Generation in a Year
Large		2000	12							
Medium	21	500	12		806.693	341.926		216.553	2306.102	3671.275
Small	82	250	12		1465.543	812.229		512.057	4732.114	7521.943
C. Path Lab Gr. Total	103				2272.235	1154.155		728.610	7038.217	11193.217

Annual BMW Generation in Birbhum District							
(Rounded off to Kg)							
Categories	CAT 1	CAT 3	CAT 4	CAT 5	CAT 6	CAT 7	Total BMW
A. Bedded Facilities	21285	3888	19792	4959	110597	62686	223208
B. Non-Bedded Facilities			3576		2588	21416	27579
C. Pathological Centres		2272	1154		729	7038	11193
Total	21285	6161	24522	4959	113914	91140	261981

BMW Generation in Burdwan District (Weight in Kg)										
A. Bedded Facilities										
Health Care Unit (HCU) Categories	No. of Units	Total Bed Strength	Frequency - Days in a Year*	CAT 1	CAT 3	CAT 4	CAT 5	CAT 6	CAT 7	Total Generation in a Year
Government										
MCH	1	1099	365	11347.919	1198.713	6179.063	1275.252	59459.747	33367.088	112827.781
DH			365							
SDH	4	770	365	5800.819	1605.348	4290.895	1358.859	37154.221	18541.717	68751.859
SGH			365							
RH	7	300	365	2543.191	474.768	2543.728	604.934	11768.566	6954.860	24890.048
BPHC	29	415	365	2960.648	1484.627	3980.522	910.858	16911.839	6520.884	32769.379
PHC	103	571	365	6838.617		5318.924	1215.754	18887.609	10909.223	43170.128
Other Government										
< 50 Beds (BPHC)	10	275	365	1961.875	983.789	2637.695	603.581	11206.641	4321.068	21714.648
50 - 100 Beds (RH)	7	385	365	3263.762	609.286	3264.451	776.332	15102.993	8925.404	31942.228
> 101 - 300 Beds (SGH)	4	798	365	7953.884	1004.936	5337.421	1639.645	35753.471	20023.561	71712.919
> 300 Beds (DH)	3	1590	365	15911.960	2587.859	9913.150	2407.016	79846.823	41837.438	152504.246
Private										
Small (< 50 Beds)	191	2420	365	28216.528		21591.778	5152.583	120226.944	100107.333	275295.167
Medium (50 - 100 Beds)	9	529	365	4508.853	1904.327	4471.721	1289.002	31349.790	28018.543	71542.236
Large (101 - 300 Beds)	3	468	365	6108.109	1213.210	6638.686	1928.195	35011.630	38379.501	89279.332
Very Large (> 300 Beds)			365							
Municipality										
Hospital	0		365							
Maternity Homes	0		365							
Specialty Hospitals										
Eye	8	70	300		35.814	324.564	113.547	488.372	497.326	1459.622
Dental			300							
Infectious Disease			365							
Leprosy	2	100	365	247.679	282.875	582.696	237.250	4502.536	2702.304	8555.339
Cancer	3	70	365	105.870	97.048	686.744	46.936	3463.013	1722.155	6121.766
TB	1	50	365	0.000	102.995	365.452	102.092	1859.332	912.048	3341.918
A. Bedded Gr. Total	385	9910		97769.714	13585.596	78127.491	19661.835	482993.527	323740.452	1015878.615
* Eye and Dental Hospitals are closed on Sundays and some holidays.										

BMW Generation in Burdwan District										
B. Non-Bedded Facilities										
Health Care Unit (HCU) Categories	No. of Units	Average No. of Patients	Frequency - Days in a Year*	CAT 1	CAT 3	CAT 4	CAT 5	CAT 6	CAT 7	Total Generation in a Year
Government										
Rural	765	30	50			4508.036		3050.893	28361.161	35920.089
Urban	255	30	50			1586.968		1017.287	9664.229	12268.484
Municipality										
ESOPD	5	30	300			223.750		156.875	698.750	1079.375
Sub Centres	226	50	104			5774.690		5688.576	25545.403	37008.669
B. Non-Bedded Gr. Total						12093.443		9913.631	64269.543	86276.617
* Clinical activities held in Govt. Sub Centres average 50 per year and Municipal Immunisation Centres twice in a week. Municipal Clinics are closed on Sundays and some holidays.										

BMW Generation in Burdwan District (Weight in Kg)										
C. Pathological Laboratories										
Health Care Unit (HCU) Categories	No. of Units	Average No. of Tests / Month	No. of Months in a Year	CAT 1	CAT 3	CAT 4	CAT 5	CAT 6	CAT 7	Total Generation in a Year
Large		2000	12							
Medium	28	500	12		1096.475	464.754		294.344	3134.508	4990.082
Small	112	250	12		1992.000	1104.000		696.000	6432.000	10224.000
C. Path Lab Gr. Total	140				3088.475	1568.754		990.344	9566.508	15214.082

Annual BMW Generation in Burdwan District (Weight in Kg)							
(Rounded off to Kg)							
Categories	CAT 1	CAT 3	CAT 4	CAT 5	CAT 6	CAT 7	Total BMW
A. Bedded Facilities	97770	13586	78127	19662	482994	323740	1015879
B. Non-Bedded Facilities			12093		9914	64270	86277
C. Pathological Centres		3088	1569		990	9567	15214
Total	97770	16674	91790	19662	493898	397577	1117369

BMW Generation in Coochbihar District (Weight in Kg)										
A. Bedded Facilities										
Health Care Unit (HCU) Categories	No. of Units	Total Bed Strength	Frequency - Days in a Year*	CAT 1	CAT 3	CAT 4	CAT 5	CAT 6	CAT 7	Total Generation in a Year
Government										
MCH			365							
DH	1	400	365	4003.009	651.034	2493.874	605.539	20087.251	10525.142	38365.848
SDH	4	520	365	3917.436	1084.131	2897.747	917.671	25091.163	12521.679	46429.827
SGH	1	120	365	1196.073	151.118	802.620	246.563	5376.462	3011.062	10783.898
RH	1	30	365	254.319	47.477	254.373	60.493	1176.857	695.486	2489.005
BPHC	10	115	365	820.420	411.403	1103.036	252.406	4686.413	1806.992	9080.671
PHC	29	158	365	1892.297		1471.786	336.408	5226.344	3018.664	11945.499
Other Government										
< 50 Beds (BPHC)	3	42	365	299.632	150.251	402.848	92.183	1711.560	659.945	3316.419
50 - 100 Beds (RH)			365							
> 101 - 300 Beds (SGH)			365							
> 300 Beds (DH)			365							
Private										
Small (< 50 Beds)	17	296	365	3451.278		2640.978	630.233	14705.444	12244.533	33672.467
Medium (50 - 100 Beds)	3	210	365	1789.904	755.971	1775.163	511.702	12445.096	11122.673	28400.510
Large (101 - 300 Beds)			365							
Very Large (> 300 Beds)			365							
Municipality										
Hospital	0		365							
Maternity Homes	0		365							
Specialty Hospitals										
Eye	1	10	300		5.116	46.366	16.221	69.767	71.047	208.517
Dental			300							
Infectious Disease			365							
Leprosy			365							
Cancer	1	15	365	22.686	20.796	147.160	10.058	742.074	369.033	1311.807
TB			365							
A. Bedded Gr. Total	71	1916		17647.054	3277.297	14035.952	3679.478	91318.431	56046.255	186004.468
* Eye and Dental Hospitals are closed on Sundays and some holidays.										

BMW Generation in Coochbihar District (Weight in Kg)										
B. Non-Bedded Facilities										
Health Care Unit (HCU) Categories	No. of Units	Average No. of Patients	Frequency - Days in a Year*	CAT 1	CAT 3	CAT 4	CAT 5	CAT 6	CAT 7	Total Generation in a Year
Government										
Rural	406	30	50			2392.500		1619.167	15051.806	19063.472
Urban	23	30	50			143.138		91.755	871.676	1106.569
Municipality										
ESOPD	0	30	300							
Sub Centres	19	50	104			485.483		478.243	2147.622	3111.348
B. Non-Bedded Gr. Total						3021.121		2189.165	18071.104	23281.390
* Clinical activities held in Govt. Sub Centres average 50 per year and Municipal Immunisation Centres twice in a week. Municipal Clinics are closed on Sundays and some holidays.										

BMW Generation in Coochbihar District (Weight in Kg)										
B. Non-Bedded Facilities										
Health Care Unit (HCU) Categories	No. of Units	Average No. of Patients	Frequency - Days in a Year*	CAT 1	CAT 3	CAT 4	CAT 5	CAT 6	CAT 7	Total Generation in a Year
Government										
Rural	406	30	50			2392.500		1619.167	15051.806	19063.472
Urban	23	30	50			143.138		91.755	871.676	1106.569
Municipality										
ESOPD	0	30	300							
Sub Centres	19	50	104			485.483		478.243	2147.622	3111.348
B. Non-Bedded Gr. Total						3021.121		2189.165	18071.104	23281.390
* Clinical activities held in Govt. Sub Centres average 50 per year and Municipal Immunisation Centres twice in a week. Municipal Clinics are closed on Sundays and some holidays.										

Annual BMW Generation in Coochbihar District							
(Rounded off to Kg)							
Categories	CAT 1	CAT 3	CAT 4	CAT 5	CAT 6	CAT 7	Total BMW
A. Bedded Facilities	17647	3277	14036	3679	91318	56046	186004
B. Non-Bedded Facilities			3021		2189	18071	23281
C. Pathological Centres		1103	560		354	3417	5434
Gr. Total	17647	4380	17617	3679	93861	77534	214719

BMW Generation in Dakshin Dinajpur District (Weight in Kg)										
A. Bedded Facilities										
Health Care Unit (HCU) Categories	No. of Units	Total Bed Strength	Frequency - Days in a Year*	CAT 1	CAT 3	CAT 4	CAT 5	CAT 6	CAT 7	Total Generation in a Year
Government										
MCH			365							
DH	1	300	365	3002.257	488.275	1870.406	454.154	15065.438	7893.856	28774.386
SDH	1	120	365	904.024	250.184	668.711	211.770	5790.268	2889.618	10714.575
SGH			365							
RH	1	25	365	211.933	39.564	211.977	50.411	980.714	579.572	2074.171
BPHC	6	110	365	784.750	393.516	1055.078	241.432	4482.656	1728.427	8685.859
PHC	19	80	365	958.125		745.208	170.333	2646.250	1528.438	6048.354
Other Government										
< 50 Beds (BPHC)			365							
50 - 100 Beds (RH)	1	50	365	423.865	79.128	423.955	100.822	1961.428	1159.143	4148.341
> 101 - 300 Beds (SGH)			365							
> 300 Beds (DH)			365							
Private										
Small (< 50 Beds)	7	106	365	1235.931		945.756	225.692	5266.139	4384.867	12058.383
Medium (50 - 100 Beds)			365							
Large (101 - 300 Beds)			365							
Very Large (> 300 Beds)			365							
Municipality										
Hospital	0		365							
Maternity Homes	1	30	365	887.910		268.062	30.575	1250.362	712.817	3149.725
Specialty Hospitals										
Eye			300							
Dental			300							
Infectious Disease			365							
Leprosy			365							
Cancer			365							
TB			365							
A. Bedded Gr. Total	37	821		8408.794	1250.667	6189.152	1485.190	37443.255	20876.737	75653.795
* Eye and Dental Hospitals are closed on Sundays and some holidays.										

BMW Generation in Dakshin Dinajpur District (Weight in Kg)										
B. Non-Bedded Facilities										
Health Care Unit (HCU) Categories	No. of Units	Average No. of Patients	Frequency - Days in a Year*	CAT 1	CAT 3	CAT 4	CAT 5	CAT 6	CAT 7	Total Generation in a Year
Government										
Rural	247	30	50			1455.536		985.060	9157.133	11597.728
Urban	20	30	50			124.468		79.787	757.979	962.234
Municipality										
ESOPD	1	30	300			44.750		31.375	139.750	215.875
Sub Centres	16	50	104			408.828		402.731	1808.524	2620.083
B. Non-Bedded Gr. Total						2033.581		1498.953	11863.386	15395.920
* Clinical activities held in Govt. Sub Centres average 50 per year and Municipal Immunisation Centres twice in a week. Municipal Clinics are closed on Sundays and some holidays.										

BMW Generation in Dakshin Dinajpur District (Weight in Kg)										
C. Pathological Laboratories										
Health Care Unit (HCU) Categories	No. of Units	Average No. of Tests / Month	No. of Months in a Year	CAT 1	CAT 3	CAT 4	CAT 5	CAT 6	CAT 7	Total Generation in a Year
Large		2000	12							
Medium	2	500	12		93.984	39.836		25.230	268.672	427.721
Small	10	250	12		170.743	94.629		59.657	551.314	876.343
C. Path Lab Gr. Total	12				264.726	134.465		84.887	819.986	1304.064

Annual BMW Generation in Dakshin Dinajpur District							
(Rounded off to Kg)							
Categories	CAT 1	CAT 3	CAT 4	CAT 5	CAT 6	CAT 7	Total BMW
A. Bedded Facilities	8409	1251	6189	1485	37443	20877	75654
B. Non-Bedded Facilities			2034		1499	11863	15396
C. Pathological Centres		265	134		85	820	1304
Gr. Total	8409	1515	8357	1485	39027	33560	92354

BMW Generation in Darjeeling District (Weight in Kg)										
A. Bedded Facilities										
Health Care Unit (HCU) Categories	No. of Units	Total Bed Strength	Frequency - Days in a Year*	CAT 1	CAT 3	CAT 4	CAT 5	CAT 6	CAT 7	Total Generation in a Year
Government										
MCH	1	1000	365	10325.677	1090.731	5622.441	1160.375	54103.500	30361.317	102664.041
DH	2	628	365	6284.724	1022.123	3915.382	950.696	31536.984	16524.472	60234.381
SDH	2	470	365	3540.760	979.888	2619.118	829.433	22678.551	11317.671	41965.421
SGH	1	50	365	498.364	62.966	334.425	102.735	2240.192	1254.609	4493.291
RH	3	110	365	932.503	174.082	932.700	221.809	4315.141	2550.115	9126.351
BPHC	8	150	365	1070.114	536.612	1438.743	329.226	6112.713	2356.946	11844.354
PHC	21	108	365	1293.469		1006.031	229.950	3572.438	2063.391	8165.278
Other Government										
< 50 Beds (BPHC)	9	141	365	1005.907	504.415	1352.418	309.472	5745.950	2215.529	11133.692
50 - 100 Beds (RH)	1	50	365	423.865	79.128	423.955	100.822	1961.428	1159.143	4148.341
> 101 - 300 Beds (SGH)			365							
> 300 Beds (DH)			365							
Private										
Small (< 50 Beds)	66	1013	365	11811.299		9038.211	2156.846	50326.403	41904.433	115237.192
Medium (50 - 100 Beds)	6	400	365	3409.341	1439.945	3381.264	974.670	23704.945	21186.044	54096.209
Large (101 - 300 Beds)	1	200	365	2610.303	518.466	2837.045	824.015	14962.235	16401.496	38153.561
Very Large (> 300 Beds)			365							
Municipality										
Hospital	1	24	365	315.832	17.082	174.947	33.625	1020.254	652.435	2214.174
Maternity Homes	1	17	365	503.149		151.902	17.326	708.538	403.929	1784.844
Specialty Hospitals										
Eye	4	95	300		48.605	440.480	154.099	662.791	674.942	1980.916
Dental			300							
Infectious Disease			365							
Leprosy			365							
Cancer	1	10	365		13.864	98.106	6.705	494.716	246.022	859.414
TB	1	334	365		688.007	2441.218	681.972	12420.336	6092.482	22324.014
A. Bedded Gr. Total	129	4800		44025.305	7175.913	36208.386	9083.776	236567.114	157364.979	490425.473
* Eye and Dental Hospitals are closed on Sundays and some holidays.										

BMW Generation in Darjeeling District (Weight in Kg)										
B. Non-Bedded Facilities										
Health Care Unit (HCU) Categories	No. of Units	Average No. of Patients	Frequency - Days in a Year*	CAT 1	CAT 3	CAT 4	CAT 5	CAT 6	CAT 7	Total Generation in a Year
Government										
Rural	230	30	50			1355.357		917.262	8526.885	10799.504
Urban	52	30	50			323.617		207.447	1970.745	2501.809
Municipality										
ESOPD	2	30	300			89.500		62.750	279.500	431.750
Sub Centres	88	50	104			2248.552		2215.021	9946.883	14410.455
B. Non-Bedded Gr. Total						4017.026		3402.479	20724.012	28143.518
* Clinical activities held in Govt. Sub Centres average 50 per year and Municipal Immunisation Centres twice in a week. Municipal Clinics are closed on Sundays and some holidays.										

BMW Generation in Darjeeling District (Weight in Kg)										
C. Pathological Laboratories										
Health Care Unit (HCU) Categories	No. of Units	Average No. of Tests / Month	No. of Months in a Year	CAT 1	CAT 3	CAT 4	CAT 5	CAT 6	CAT 7	Total Generation in a Year
Large	1	2000	12	120.000	144.000	91.813		95.188	446.813	897.813
Medium	11	500	12		446.422	189.221		119.840	1276.193	2031.676
Small	45	250	12		800.357	443.571		279.643	2584.286	4107.857
C. Path Lab Gr. Total	57			120.000	1390.779	724.605		494.671	4307.291	7037.346

Annual BMW Generation in Darjeeling District							
(Rounded off to Kg)							
Categories	CAT 1	CAT 3	CAT 4	CAT 5	CAT 6	CAT 7	Total BMW
A. Bedded Facilities	44025	7176	36208	9084	236567	157365	490425
B. Non-Bedded Facilities			4017		3402	20724	28144
C. Pathological Centres	120	1391	725		495	4307	7037
Gr. Total	44145	8567	40950	9084	240464	182396	525606

BMW Generation in East Midnapore District (Weight in Kg)										
A. Bedded Facilities										
Health Care Unit (HCU) Categories	No. of Units	Total Bed Strength	Frequency - Days in a Year*	CAT 1	CAT 3	CAT 4	CAT 5	CAT 6	CAT 7	Total Generation in a Year
Government										
MCH			365							
DH	1	336	365	3362.527	546.868	2094.854	508.652	16873.291	8841.119	32227.312
SDH	3	299	365	2252.526	623.375	1666.205	527.661	14427.418	7199.965	26697.151
SGH	3	60	365	598.036	75.559	401.310	123.282	2688.231	1505.531	5391.949
RH	3	85	365	720.571	134.518	720.723	171.398	3334.427	1970.544	7052.180
BPHC	21	282	365	2011.814	1008.831	2704.837	618.945	11491.901	4431.059	22267.385
PHC	55	301	365	3604.945		2803.846	640.879	9956.516	5750.746	22756.933
Other Government										
< 50 Beds (BPHC)	3	82	365	584.995	293.348	786.513	179.977	3341.616	1288.464	6474.913
50 - 100 Beds (RH)			365							
> 101 - 300 Beds (SGH)			365							
> 300 Beds (DH)			365							
Private										
Small (< 50 Beds)	121	1116	365	13012.250		9957.200	2376.150	55443.500	46165.200	126954.300
Medium (50 - 100 Beds)	2	200	365	1704.670	719.973	1690.632	487.335	11852.473	10593.022	27048.104
Large (101 - 300 Beds)			365							
Very Large (> 300 Beds)			365							
Municipality										
Hospital	0		365							
Maternity Homes	0		365							
Specialty Hospitals										
Eye	1	20	300		10.233	92.733	32.442	139.535	142.093	417.035
Dental			300							
Infectious Disease			365							
Leprosy			365							
Cancer			365							
TB			365							
A. Bedded Gr. Total	213	2781		27852.335	3412.704	22918.852	5666.720	129548.907	87887.742	277287.262
* Eye and Dental Hospitals are closed on Sundays and some holidays.										

BMW Generation in East Midnapore District (Weight in Kg)										
B. Non-Bedded Facilities										
Health Care Unit (HCU) Categories	No. of Units	Average No. of Patients	Frequency - Days in a Year*	CAT 1	CAT 3	CAT 4	CAT 5	CAT 6	CAT 7	Total Generation in a Year
Government										
Rural	706	30	50			4160.357		2815.595	26173.829	33149.782
Urban	37	30	50			230.266		147.606	1402.261	1780.133
Municipality										
ESOPD	0	30	300							
Sub Centres	26	50	104			664.345		654.438	2938.852	4257.634
B. Non-Bedded Gr. Total						5054.968		3617.640	30514.942	39187.549

* Clinical activities held in Govt. Sub Centres average 50 per year and Municipal Immunisation Centres twice in a week. Municipal Clinics are closed on Sundays and some holidays.

BMW Generation in East Midnapore District (Weight in Kg)										
C. Pathological Laboratories										
Health Care Unit (HCU) Categories	No. of Units	Average No. of Tests / Month	No. of Months in a Year	CAT 1	CAT 3	CAT 4	CAT 5	CAT 6	CAT 7	Total Generation in a Year
Large		2000	12							
Medium	23	500	12		908.508	385.082		243.885	2597.164	4134.639
Small	93	250	12		1650.514	914.743		576.686	5329.371	8471.314
C. Path Lab Gr. Total	116				2559.022	1299.825		820.571	7926.535	12605.954

Annual BMW Generation in East Midnapore District							
(Rounded off to Kg)							
Categories	CAT 1	CAT 3	CAT 4	CAT 5	CAT 6	CAT 7	Total BMW
A. Bedded Facilities	27852	3413	22919	5667	129549	87888	277287
B. Non-Bedded Facilities			5055		3618	30515	39188
C. Pathological Centres		2559	1300		821	7927	12606
Gr. Total	27852	5972	29274	5667	133987	126329	329081

BMW Generation in Hoogly District (Weight in Kg)										
A. Bedded Facilities										
Health Care Unit (HCU) Categories	No. of Units	Total Bed Strength	Frequency - Days in a Year*	CAT 1	CAT 3	CAT 4	CAT 5	CAT 6	CAT 7	Total Generation in a Year
Government										
MCH			365							
DH	1	540	365	5404.062	878.895	3366.730	817.477	27117.789	14208.941	51793.895
SDH	3	766	365	5770.685	1597.008	4268.604	1351.800	36961.213	18445.396	68394.707
SGH	1	204	365	2033.324	256.901	1364.454	419.157	9139.985	5118.805	18332.626
RH	8	320	365	2712.737	506.420	2713.310	645.263	12553.137	7418.518	26549.384
BPHC	9	121	365	863.225	432.867	1160.586	265.576	4930.922	1901.270	9554.445
PHC	60	395	365	4730.742		3679.466	841.021	13065.859	7546.660	29863.749
Other Government										
< 50 Beds (BPHC)	4	43	365	306.766	153.829	412.440	94.378	1752.311	675.658	3395.381
50 - 100 Beds (RH)	1	99	365	839.253	156.674	839.430	199.628	3883.627	2295.104	8213.716
> 101 - 300 Beds (SGH)	3	718	365	7156.503	904.191	4802.341	1475.270	32169.163	18016.187	64523.654
> 300 Beds (DH)			365							
Private										
Small (< 50 Beds)	189	2182	365	25441.514		19468.289	4645.842	108402.972	90262.067	248220.683
Medium (50 - 100 Beds)	8	561	365	4781.600	2019.523	4742.222	1366.975	33246.185	29713.427	75869.933
Large (101 - 300 Beds)	2	326	365	4254.794	845.099	4624.384	1343.145	24388.443	26734.439	62190.304
Very Large (> 300 Beds)			365							
Municipality										
Hospital	1	40	365	526.386	28.470	291.579	56.042	1700.423	1087.391	3690.290
Maternity Homes	6	213	365	6304.160		1903.238	217.080	8877.570	5060.998	22363.046
Specialty Hospitals										
Eye	7	100	300		51.163	463.663	162.209	697.674	710.465	2085.174
Dental			300							
Infectious Disease			365							
Leprosy			365							
Cancer	1	30	365	45.373	41.592	294.319	20.115	1484.148	738.066	2623.614
TB	1	55	365		113.295	401.997	112.301	2045.265	1003.253	3676.110
A. Bedded Gr. Total	305	6713		71171.124	7985.926	54797.052	14033.278	322416.687	230936.644	701340.712
* Eye and Dental Hospitals are closed on Sundays and some holidays.										

BMW Generation in Hoogly District (Weight in Kg)										
B. Non-Bedded Facilities										
Health Care Unit (HCU) Categories	No. of Units	Average No. of Patients	Frequency - Days in a Year*	CAT 1	CAT 3	CAT 4	CAT 5	CAT 6	CAT 7	Total Generation in a Year
Government										
Rural	660	30	50			3889.286		2632.143	24468.452	30989.881
Urban	169	30	50			1051.755		674.202	6404.920	8130.878
Health Camps										
Municipality										
ESOPD	9	30	300			402.750		282.375	1257.750	1942.875
Sub Centres	212	50	104			5416.966		5336.186	23962.945	34716.097
B. Non-Bedded Gr. Total						10760.757		8924.906	56094.067	75779.730
* Clinical activities held in Govt. Sub Centres average 50 per year and Municipal Immunisation Centres twice in a week. Municipal Clinics are closed on Sundays and some holidays.										

BMW Generation in Hoogly District (Weight in Kg)										
C. Pathological Laboratories										
Health Care Unit (HCU) Categories	No. of Units	Average No. of Tests / Month	No. of Months in a Year	CAT 1	CAT 3	CAT 4	CAT 5	CAT 6	CAT 7	Total Generation in a Year
Large		2000	12							
Medium	66	500	12		2576.717	1092.172		691.709	7366.094	11726.693
Small	263	250	12		4681.200	2594.400		1635.600	15115.200	24026.400
C. Path Lab Gr. Total	329				7257.917	3686.572		2327.309	22481.294	35753.093

Annual BMW Generation in Hoogly District							
(Rounded off to Kg)							
Categories	CAT 1	CAT 3	CAT 4	CAT 5	CAT 6	CAT 7	Total BMW
A. Bedded Facilities	71171	7986	54797	14033	322417	230937	701341
B. Non-Bedded Facilities			10761		8925	56094	75780
C. Pathological Centres		7258	3687		2327	22481	35753
Gr. Total	71171	15244	69244	14033	333669	309512	812874

BMW Generation in Howrah District (Weight in Kg)										
A. Bedded Facilities										
Health Care Unit (HCU) Categories	No. of Units	Total Bed Strength	Frequency - Days in a Year*	CAT 1	CAT 3	CAT 4	CAT 5	CAT 6	CAT 7	Total Generation in a Year
Government										
MCH			365							
DH	1	544	365	5444.092	885.406	3391.669	823.533	27318.662	14314.193	52177.553
SDH	1	210	365	1582.042	437.822	1170.244	370.598	10132.969	5056.832	18750.507
SGH	8	544	365	5422.197	685.069	3638.543	1117.753	24373.293	13650.147	48887.002
RH	6	240	365	2034.553	379.815	2034.982	483.947	9414.853	5563.888	19912.038
BPHC	9	110	365	784.750	393.516	1055.078	241.432	4482.656	1728.427	8685.859
PHC	41	254	365	3042.047		2366.036	540.808	8401.844	4852.789	19203.524
Other Government										
< 50 Beds (BPHC)	3	48	365	342.436	171.716	460.398	105.352	1956.068	754.223	3790.193
50 - 100 Beds (RH)			365							
> 101 - 300 Beds (SGH)	6	1000	365	9967.274	1259.319	6688.498	2054.693	44803.848	25092.182	89865.813
> 300 Beds (DH)			365							
Private										
Small (< 50 Beds)	138	1493	365	17407.965		13320.878	3178.846	74173.069	61760.433	169841.192
Medium (50 - 100 Beds)	1	50	365	426.168	179.993	422.658	121.834	2963.118	2648.255	6762.026
Large (101 - 300 Beds)	2	265	365	3458.652	686.967	3759.085	1091.820	19824.961	21731.982	50553.468
Very Large (> 300 Beds)			365							
Municipality										
Hospital	1	35	365	460.588	24.911	255.131	49.036	1487.870	951.467	3229.004
Maternity Homes	2	29	365	858.313		259.126	29.556	1208.683	689.056	3044.734
Specialty Hospitals										
Eye	10	42	300		21.488	194.738	68.128	293.023	298.395	875.773
Dental			300							
Infectious Disease	1	52	365		124.585	401.806	105.652	2364.786	1473.989	4470.818
Leprosy			365							
Cancer			365							
TB	1	48	365		98.875	350.834	98.008	1784.958	875.566	3208.242
A. Bedded Gr. Total	231	4964		51231.076	5349.483	39769.704	10480.996	234984.664	161441.825	503257.748

* Eye and Dental Hospitals are closed on Sundays and some holidays.

BMW Generation in Howrah District (Weight in Kg)										
B. Non-Bedded Facilities										
Health Care Unit (HCU) Categories	No. of Units	Average No. of Patients	Frequency - Days in a Year*	CAT 1	CAT 3	CAT 4	CAT 5	CAT 6	CAT 7	Total Generation in a Year
Government										
Rural	448	30	50			2640.000		1786.667	16608.889	21035.556
Urban	215	30	50			1338.032		857.713	8148.271	10344.016
Municipality										
ESOPD	3	30	300			134.250		94.125	419.250	647.625
Sub Centres	123	50	104			3142.862		3095.995	13903.029	20141.886
B. Non-Bedded Gr. Total						7255.144		5834.499	39079.439	52169.083
* Clinical activities held in Govt. Sub Centres average 50 per year and Municipal Immunisation Centres twice in a week. Municipal Clinics are closed on Sundays and some holidays.										

BMW Generation in Howrah District (Weight in Kg)										
C. Pathological Laboratories										
Health Care Unit (HCU) Categories	No. of Units	Average No. of Tests / Month	No. of Months in a Year	CAT 1	CAT 3	CAT 4	CAT 5	CAT 6	CAT 7	Total Generation in a Year
Large		2000	12							
Medium	29	500	12		1143.467	484.672		306.959	3268.844	5203.943
Small	117	250	12		2077.371	1151.314		725.829	6707.657	10662.171
C. Path Lab Gr. Total	146				3220.839	1635.986		1032.788	9976.501	15866.114

Annual BMW Generation in Howrah District							
(Rounded off to Kg)							
Categories	CAT 1	CAT 3	CAT 4	CAT 5	CAT 6	CAT 7	Total BMW
A. Bedded Facilities	51231	5349	39770	10481	234985	161442	503258
B. Non-Bedded Facilities			7255		5834	39079	52169
C. Pathological Centres		3221	1636		1033	9977	15866
Gr. Total	51231	8570	48661	10481	241852	210498	571293

BMW Generation in Howrah District (Weight in Kg)										
A. Bedded Facilities										
Health Care Unit (HCU) Categories	No. of Units	Total Bed Strength	Frequency - Days in a Year*	CAT 1	CAT 3	CAT 4	CAT 5	CAT 6	CAT 7	Total Generation in a Year
Government										
MCH			365							
DH	1	544	365	5444.092	885.406	3391.669	823.533	27318.662	14314.193	52177.553
SDH	1	210	365	1582.042	437.822	1170.244	370.598	10132.969	5056.832	18750.507
SGH	8	544	365	5422.197	685.069	3638.543	1117.753	24373.293	13650.147	48887.002
RH	6	240	365	2034.553	379.815	2034.982	483.947	9414.853	5563.888	19912.038
BPHC	9	110	365	784.750	393.516	1055.078	241.432	4482.656	1728.427	8685.859
PHC	41	254	365	3042.047		2366.036	540.808	8401.844	4852.789	19203.524
Other Government										
< 50 Beds (BPHC)	3	48	365	342.436	171.716	460.398	105.352	1956.068	754.223	3790.193
50 - 100 Beds (RH)			365							
> 101 - 300 Beds (SGH)	6	1000	365	9967.274	1259.319	6688.498	2054.693	44803.848	25092.182	89865.813
> 300 Beds (DH)			365							
Private										
Small (< 50 Beds)	138	1493	365	17407.965		13320.878	3178.846	74173.069	61760.433	169841.192
Medium (50 - 100 Beds)	1	50	365	426.168	179.993	422.658	121.834	2963.118	2648.255	6762.026
Large (101 - 300 Beds)	2	265	365	3458.652	686.967	3759.085	1091.820	19824.961	21731.982	50553.468
Very Large (> 300 Beds)			365							
Municipality										
Hospital	1	35	365	460.588	24.911	255.131	49.036	1487.870	951.467	3229.004
Maternity Homes	2	29	365	858.313		259.126	29.556	1208.683	689.056	3044.734
Specialty Hospitals										
Eye	10	42	300		21.488	194.738	68.128	293.023	298.395	875.773
Dental			300							
Infectious Disease	1	52	365		124.585	401.806	105.652	2364.786	1473.989	4470.818
Leprosy			365							
Cancer			365							
TB	1	48	365		98.875	350.834	98.008	1784.958	875.566	3208.242
A. Bedded Gr. Total	231	4964		51231.076	5349.483	39769.704	10480.996	234984.664	161441.825	503257.748

* Eye and Dental Hospitals are closed on Sundays and some holidays.

BMW Generation in Howrah District (Weight in Kg)										
B. Non-Bedded Facilities										
Health Care Unit (HCU) Categories	No. of Units	Average No. of Patients	Frequency - Days in a Year*	CAT 1	CAT 3	CAT 4	CAT 5	CAT 6	CAT 7	Total Generation in a Year
Government										
Rural	448	30	50			2640.000		1786.667	16608.889	21035.556
Urban	215	30	50			1338.032		857.713	8148.271	10344.016
Municipality										
ESOPD	3	30	300			134.250		94.125	419.250	647.625
Sub Centres	123	50	104			3142.862		3095.995	13903.029	20141.886
B. Non-Bedded Gr. Total						7255.144		5834.499	39079.439	52169.083
* Clinical activities held in Govt. Sub Centres average 50 per year and Municipal Immunisation Centres twice in a week. Municipal Clinics are closed on Sundays and some holidays.										

BMW Generation in Howrah District (Weight in Kg)										
C. Pathological Laboratories										
Health Care Unit (HCU) Categories	No. of Units	Average No. of Tests / Month	No. of Months in a Year	CAT 1	CAT 3	CAT 4	CAT 5	CAT 6	CAT 7	Total Generation in a Year
Large		2000	12							
Medium	29	500	12		1143.467	484.672		306.959	3268.844	5203.943
Small	117	250	12		2077.371	1151.314		725.829	6707.657	10662.171
C. Path Lab Gr. Total	146				3220.839	1635.986		1032.788	9976.501	15866.114

Annual BMW Generation in Howrah District							
(Rounded off to Kg)							
Categories	CAT 1	CAT 3	CAT 4	CAT 5	CAT 6	CAT 7	Total BMW
A. Bedded Facilities	51231	5349	39770	10481	234985	161442	503258
B. Non-Bedded Facilities			7255		5834	39079	52169
C. Pathological Centres		3221	1636		1033	9977	15866
Gr. Total	51231	8570	48661	10481	241852	210498	571293

BMW Generation in Jalpaiguri District (Weight in Kg)										
A. Bedded Facilities										
Health Care Unit (HCU) Categories	No. of Units	Total Bed Strength	Frequency - Days in a Year*	CAT 1	CAT 3	CAT 4	CAT 5	CAT 6	CAT 7	Total Generation in a Year
Government										
MCH			365							
DH	1	610	365	6104.588	992.826	3803.158	923.446	30633.058	16050.841	58507.918
SDH	2	325	365	2448.398	677.582	1811.092	573.544	15681.977	7826.049	29018.642
SGH	1	100	365	996.727	125.932	668.850	205.469	4480.385	2509.218	8986.581
RH	5	165	365	1398.755	261.123	1399.050	332.714	6472.711	3825.173	13689.526
BPHC	8	115	365	820.420	411.403	1103.036	252.406	4686.413	1806.992	9080.671
PHC	38	198	365	2371.359		1844.391	421.575	6549.469	3782.883	14969.677
Other Government										
< 50 Beds (BPHC)	5	71	365	506.520	253.996	681.005	155.834	2893.351	1115.621	5606.327
50 - 100 Beds (RH)			365							
> 101 - 300 Beds (SGH)	1	111	365	1106.367	139.784	742.423	228.071	4973.227	2785.232	9975.105
> 300 Beds (DH)			365							
Private										
Small (< 50 Beds)	52	871	365	10155.618		7771.256	1854.504	43271.764	36030.367	99083.508
Medium (50 - 100 Beds)			365							
Large (101 - 300 Beds)			365							
Very Large (> 300 Beds)			365							
Municipality										
Hospital	0		365							
Maternity Homes	0		365							
Specialty Hospitals										
Eye	1	25	300		12.791	115.916	40.552	174.419	177.616	521.294
Dental			300							
Infectious Disease			365							
Leprosy			365							
Cancer			365							
TB	1	60	365		123.594	438.542	122.510	2231.198	1094.458	4010.302
A. Bedded Gr. Total	115	2651		25908.754	2999.031	20378.719	5110.626	122047.971	77004.450	253449.552
* Eye and Dental Hospitals are closed on Sundays and some holidays.										

BMW Generation in Jalpaiguri District (Weight in Kg)										
B. Non-Bedded Facilities										
Health Care Unit (HCU) Categories	No. of Units	Average No. of Patients	Frequency - Days in a Year*	CAT 1	CAT 3	CAT 4	CAT 5	CAT 6	CAT 7	Total Generation in a Year
Government										
Rural	537	30	50			3164.464		2141.607	19908.423	25214.494
Urban	61	30	50			379.628		243.351	2311.835	2934.814
Municipality										
ESOPD	2	30	300			89.500		62.750	279.500	431.750
Sub Centres	27	50	104			689.897		679.609	3051.884	4421.390
B. Non-Bedded Gr. Total						4323.488		3127.317	25551.642	33002.448
* Clinical activities held in Govt. Sub Centres average 50 per year and Municipal Immunisation Centres twice in a week. Municipal Clinics are closed on Sundays and some holidays.										

BMW Generation in Jalpaiguri District (Weight in Kg)										
C. Pathological Laboratories										
Health Care Unit (HCU) Categories	No. of Units	Average No. of Tests / Month	No. of Months in a Year	CAT 1	CAT 3	CAT 4	CAT 5	CAT 6	CAT 7	Total Generation in a Year
Large		2000	12							
Medium	21	500	12		814.525	345.246		218.656	2328.492	3706.918
Small	83	250	12		1479.771	820.114		517.029	4778.057	7594.971
C. Path Lab Gr. Total	104				2294.296	1165.360		735.684	7106.549	11301.889

Annual BMW Generation in Jalpaiguri District							
(Rounded off to Kg)							
Categories	CAT 1	CAT 3	CAT 4	CAT 5	CAT 6	CAT 7	Total BMW
A. Bedded Facilities	25909	2999	20379	5111	122048	77004	253450
B. Non-Bedded Facilities			4323		3127	25552	33002
C. Pathological Centres		2294	1165		736	7107	11302
Gr. Total	25909	5293	25868	5111	125911	109663	297754

BMW Generation in Kolkata District (Weight in Kg)										
A. Bedded Facilities										
Health Care Unit (HCU) Categories	No. of Units	Total Bed Strength	Frequency - Days in a Year*	CAT 1	CAT 3	CAT 4	CAT 5	CAT 6	CAT 7	Total Generation in a Year
Government										
MCH	6	7745	365	79972.367	8447.709	43545.807	8987.103	419031.608	235148.402	795132.995
DH	1	600	365	6004.513	976.550	3740.811	908.308	30130.877	15787.712	57548.772
SDH			365							
SGH	18	2994	365	29842.018	3770.400	20025.362	6151.751	134142.721	75125.992	269058.244
RH			365							
BPHC			365							
PHC			365							
Other Government										
< 50 Beds (BPHC)	4	101	365	720.543	361.319	968.754	221.679	4115.893	1587.010	7975.198
50 - 100 Beds (RH)	4	226	365	1915.871	357.659	1916.275	455.717	8865.653	5239.328	18750.503
> 101 - 300 Beds (SGH)	4	776	365	7734.604	977.231	5190.274	1594.442	34767.786	19471.533	69735.871
> 300 Beds (DH)	3	1186	365	11868.921	1930.315	7394.337	1795.422	59558.700	31207.045	113754.739
Private										
Small (< 50 Beds)	284	4144	365	48317.889		36973.689	8823.267	205876.222	171423.467	471414.533
Medium (50 - 100 Beds)	28	1927	365	16424.499	6936.935	16289.238	4695.474	114198.573	102063.767	260608.486
Large (101 - 300 Beds)	21	3755	365	49008.439	9734.197	53265.528	15470.884	280915.959	307938.091	716333.100
Very Large (> 300 Beds)	6	2198	365	28513.605	8034.930	27700.329	7747.531	180082.710	182779.364	434858.468
Municipality										
Hospital	0		365							
Maternity Homes **	7	260	365	7695.219		2323.201	264.981	10836.471	6177.744	27297.615
Specialty Hospitals										
Eye	26	219	300		112.047	1015.422	355.238	1527.907	1555.919	4566.532
Dental	1	100	300	107.090	57.836	95.149	14.179	357.090	548.134	1179.478
Infectious Disease	1	780	365		1868.782	6027.085	1584.783	35471.797	22109.830	67062.277
Leprosy	1	70	365	173.375	198.013	407.888	166.075	3151.775	1891.613	5988.738
Cancer	2	460	365	695.718	637.742	4512.892	308.435	22756.943	11317.017	40228.747
TB	2	500	365		1029.950	3654.517	1020.916	18593.317	9120.483	33419.183
A. Bedded Gr. Total	419	28041		288994.671	45431.615	235046.558	60566.186	1564382.001	1200492.450	3394913.480

* Eye and Dental Hospitals are closed on Sundays and some holidays. ** MH - Govt. - 2, KMC - 4, Private - 1 Total 7

BMW Generation in Kolkata District (Weight in Kg)										
B. Non-Bedded Facilities										
Health Care Unit (HCU) Categories	No. of Units	Average No. of Patients	Frequency - Days in a Year*	CAT 1	CAT 3	CAT 4	CAT 5	CAT 6	CAT 7	Total Generation in a Year
Government										
Rural	0	30	50							
Urban	300	30	50			1867.021		1196.809	11369.681	14433.511
Municipality										
ESOPD	2	30	300			89.500		62.750	279.500	431.750
Sub Centres	152	50	104			3883.862		3825.945	17180.979	24890.786
B. Non-Bedded Gr. Total						5840.383		5085.503	28830.160	39756.047
* Clinical activities held in Govt. Sub Centres average 50 per year and Municipal Immunisation Centres twice in a week. Municipal Clinics are closed on Sundays and some holidays.										

BMW Generation in Kolkata District (Weight in Kg)										
C. Pathological Laboratories										
Health Care Unit (HCU) Categories	No. of Units	Average No. of Tests / Month	No. of Months in a Year	CAT 1	CAT 3	CAT 4	CAT 5	CAT 6	CAT 7	Total Generation in a Year
Large	4	2000	12	480.000	576.000	367.250		380.750	1787.250	3591.250
Medium	96	500	12		3759.344	1593.443		1009.180	10746.885	17108.852
Small	380	250	12		6758.571	3745.714		2361.429	21822.857	34688.571
C. Path Lab Gr. Total	480			480.000	11093.916	5706.407		3751.359	34356.992	55388.674

Annual BMW Generation in Kolkata District							
(Rounded off to Kg)							
Categories	CAT 1	CAT 3	CAT 4	CAT 5	CAT 6	CAT 7	Total BMW
A. Bedded Facilities	288995	45432	235047	60566	1564382	1200492	3394913
B. Non-Bedded Facilities			5840		5086	28830	39756
C. Pathological Centres	480	11094	5706		3751	34357	55389
Gr. Total	289475	56526	246593	60566	1573219	1263680	3490058

D. BMW Generation in Vateriaary Hospital in Kolkata (Weight in Kg)*										
Categories	No. of Units	Average No. of Animals	Frequency - Days in a Year*	CAT 2	CAT 3	CAT 4	CAT 5	CAT 6	CAT 7	Total Generation in a Year
Vateriaary	1	100	300	39.706	145.588	141.176	108.824	1000.000	1591.176	3026.471

E. BMW Generation Forensic Laboratories in Kolkata (Weight in Kg) *										
Categories	No. of Units	Average Generation in a month	Months	CAT 1	CAT 3	CAT 4	CAT 5	CAT 6	CAT 7	Total BMW
State Forensic	1	250	12		3000					
Central Forensic	1	250	12		3000					
Gr. Total	2				6000					

* These two items have not been included in final quantification summary.

BMW Generation in Malda District (Weight in Kg)										
A. Bedded Facilities										
Health Care Unit (HCU) Categories	No. of Units	Total Bed Strength	Frequency - Days in a Year*	CAT 1	CAT 3	CAT 4	CAT 5	CAT 6	CAT 7	Total Generation in a Year
Government										
MCH			365							
DH	1	600	365	6004.513	976.550	3740.811	908.308	30130.877	15787.712	57548.772
SDH			365							
SGH	1*	30**	365							
RH	6	238	365	2017.598	376.650	2018.024	479.914	9336.396	5517.523	19746.105
BPHC	9	135	365	963.102	482.951	1294.869	296.303	5501.442	2121.251	10659.918
PHC	36	219	365	2622.867		2040.008	466.288	7244.109	4184.098	16557.370
Other Government										
< 50 Beds (BPHC)	3	64	365	456.582	228.955	613.864	140.470	2608.091	1005.630	5053.591
50 - 100 Beds (RH)	1	100	365	847.730	158.256	847.909	201.645	3922.855	2318.287	8296.683
> 101 - 300 Beds (SGH)			365							
> 300 Beds (DH)			365							
Private										
Small (< 50 Beds)	21	313	365	3649.493	0.000	2792.656	666.429	15550.014	12947.767	35606.358
Medium (50 - 100 Beds)	1	60	365	511.401	215.992	507.190	146.201	3555.742	3177.907	8114.431
Large (101 - 300 Beds)			365							
Very Large (> 300 Beds)			365							
Municipality										
Hospital	0		365							
Maternity Homes	1	18	365	532.746	0.000	160.837	18.345	750.217	427.690	1889.835
Specialty Hospitals										
Eye	1	5	300	0.000	2.558	23.183	8.110	34.884	35.523	104.259
Dental			300							
Infectious Disease			365							
Leprosy			365							
Cancer			365							
TB	1	30	365		61.797	219.271	61.255	1115.599	547.229	2005.151
A. Bedded Gr. Total	81	1782		17606.033	2503.709	14258.621	3393.267	79750.226	48070.616	165582.472
* Eye and Dental Hospitals are closed on Sundays and some holidays.										

BMW Generation in Malda District (Weight in Kg)										
B. Non-Bedded Facilities										
Health Care Unit (HCU) Categories	No. of Units	Average No. of Patients	Frequency - Days in a Year*	CAT 1	CAT 3	CAT 4	CAT 5	CAT 6	CAT 7	Total Generation in a Year
Government										
Rural	511	30	50			3011.250		2037.917	18944.514	23993.681
Urban	24	30	50			149.362		95.745	909.574	1154.681
Municipality										
ESOPD	1	30	300			44.750		31.375	139.750	215.875
Sub Centres	18	50	104			459.931		453.072	2034.590	2947.593
B. Non-Bedded Gr. Total						3665.293		2618.109	22028.428	28311.830
* Clinical activities held in Govt. Sub Centres average 50 per year and Municipal Immunisation Centres twice in a week. Municipal Clinics are closed on Sundays and some holidays.										

BMW Generation in Malda District (Weight in Kg)										
C. Pathological Laboratories										
Health Care Unit (HCU) Categories	No. of Units	Average No. of Tests / Month	No. of Months in a Year	CAT 1	CAT 3	CAT 4	CAT 5	CAT 6	CAT 7	Total Generation in a Year
Large		2000	12							
Medium	3	500	12		133.143	56.434		35.742	380.619	605.939
Small	14	250	12		241.886	134.057		84.514	781.029	1241.486
C. Path Lab Gr. Total	17				375.029	190.492		120.256	1161.647	1847.424

Annual BMW Generation in Malda District							
(Rounded off to Kg)							
Categories	CAT 1	CAT 3	CAT 4	CAT 5	CAT 6	CAT 7	Total BMW
A. Bedded Facilities	17606	2504	14259	3393	79750	48071	165582
B. Non-Bedded Facilities			3665		2618	22028	28312
C. Pathological Centres		375	190		120	1162	1847
Gr. Total	17606	2879	18114	3393	82489	71261	195742

BMW Generation in Murshidabad District (Weight in Kg)										
A. Bedded Facilities										
Health Care Unit (HCU) Categories	No. of Units	Total Bed Strength	Frequency - Days in a Year*	CAT 1	CAT 3	CAT 4	CAT 5	CAT 6	CAT 7	Total Generation in a Year
Government										
MCH			365							
DH	1	391	365	3912.941	636.385	2437.762	591.914	19635.288	10288.326	37502.616
SDH	5	789	365	5943.956	1644.960	4396.774	1392.389	38071.014	18999.240	70448.334
SGH	2	245	365	2441.982	308.533	1638.682	503.400	10976.943	6147.585	22017.124
RH	10	380	365	3221.375	601.373	3222.055	766.250	14906.850	8809.490	31527.394
BPHC	18	314	365	2240.105	1123.308	3011.768	689.179	12795.946	4933.874	24794.180
PHC	70	426	365	5102.016		3968.234	907.025	14091.281	8138.930	32207.486
Other Government										
< 50 Beds (BPHC)	4	56	365	399.509	200.335	537.131	122.911	2282.080	879.927	4421.892
50 - 100 Beds (RH)	4	230	365	1949.780	363.989	1950.191	463.783	9022.567	5332.060	19082.370
> 101 - 300 Beds (SGH)			365							
> 300 Beds (DH)	1	350	365	3502.633	569.654	2182.140	529.846	17576.345	9209.499	33570.117
Private										
Small (< 50 Beds)	87	796	365	9281.139		7102.089	1694.817	39545.722	32927.867	90551.633
Medium (50 - 100 Beds)	1	50	365	426.168	179.993	422.658	121.834	2963.118	2648.255	6762.026
Large (101 - 300 Beds)	1	104	365	1357.358	269.602	1475.264	428.488	7780.362	8528.778	19839.852
Very Large (> 300 Beds)			365							
Municipality										
Hospital	0		365							
Maternity Homes**	1	5	365	147.985		44.677	5.096	208.394	118.803	524.954
Specialty Hospitals										
Eye	2	25	300		12.791	115.916	40.552	174.419	177.616	521.294
Dental			300							
Infectious Disease			365							
Leprosy			365							
Cancer			365							
TB			365							
A. Bedded Gr. Total	207	4161		39926.946	5910.925	32505.341	8257.483	190030.329	117140.247	393771.272
* Eye and Dental Hospitals are closed on Sundays and some holidays. ** Maternity Home belongs to Govt.										

BMW Generation in Murshidabad District (Weight in Kg)										
B. Non-Bedded Facilities										
Health Care Unit (HCU) Categories	No. of Units	Average No. of Patients	Frequency - Days in a Year*	CAT 1	CAT 3	CAT 4	CAT 5	CAT 6	CAT 7	Total Generation in a Year
Government										
Rural	832	30	50			4902.857		3318.095	30845.079	39066.032
Urban	73	30	50			454.309		291.223	2766.622	3512.154
Municipality										
ESOPD	0	30	300							
Sub Centres	31	50	104			792.103		780.291	3504.016	5076.410
B. Non-Bedded Gr. Total						6149.269		4389.610	37115.717	47654.596
* Clinical activities held in Govt. Sub Centres average 50 per year and Municipal Immunisation Centres twice in a week. Municipal Clinics are closed on Sundays and some holidays.										

BMW Generation in Murshidabad District (Weight in Kg)										
C. Pathological Laboratories										
Health Care Unit (HCU) Categories	No. of Units	Average No. of Tests / Month	No. of Months in a Year	CAT 1	CAT 3	CAT 4	CAT 5	CAT 6	CAT 7	Total Generation in a Year
Large		2000	12							
Medium	24	500	12		924.172	391.721		248.090	2641.943	4205.926
Small	94	250	12		1678.971	930.514		586.629	5421.257	8617.371
C. Path Lab Gr. Total	118				2603.144	1322.236		834.719	8063.200	12823.298

Annual BMW Generation in Murshidabad District							
(Rounded off to Kg)							
Categories	CAT 1	CAT 3	CAT 4	CAT 5	CAT 6	CAT 7	Total BMW
A. Bedded Facilities	39927	5911	32505	8257	190030	117140	393771
B. Non-Bedded Facilities			6149		4390	37116	47655
C. Pathological Centres		2603	1322		835	8063	12823
Gr. Total	39927	8514	39977	8257	195255	162319	454249

BMW Generation in Nadia District (Weight in Kg)										
A. Bedded Facilities										
Health Care Unit (HCU) Categories	No. of Units	Total Bed Strength	Frequency - Days in a Year*	CAT 1	CAT 3	CAT 4	CAT 5	CAT 6	CAT 7	Total Generation in a Year
Government										
MCH			365							
DH	2	895	365	8956.732	1456.688	5580.044	1354.893	44945.224	23550.004	85843.585
SDH	2	186	365	1401.237	387.785	1036.502	328.244	8974.916	4478.908	16607.592
SGH	6	1286	365	12817.914	1619.484	8601.408	2642.335	57617.749	32268.546	115567.435
RH	7	240	365	2034.553	379.815	2034.982	483.947	9414.853	5563.888	19912.038
BPHC	7	95	365	677.739	339.854	911.204	208.510	3871.385	1492.732	7501.424
PHC	49	360	365	4311.563		3353.438	766.500	11908.125	6877.969	27217.594
Other Government										
< 50 Beds (BPHC)	3	89	365	634.934	318.390	853.654	195.341	3626.876	1398.455	7027.650
50 - 100 Beds (RH)			365							
> 101 - 300 Beds (SGH)	1	250	365	2491.818	314.830	1672.124	513.673	11200.962	6273.045	22466.453
> 300 Beds (DH)			365							
Private										
Small (< 50 Beds)	73	921	365	10738.604		8217.367	1960.963	45755.792	38098.700	104771.425
Medium (50 - 100 Beds)			365							
Large (101 - 300 Beds)	2	305	365	3980.712	790.661	4326.494	1256.623	22817.408	25012.282	58184.180
Very Large (> 300 Beds)			365							
Municipality										
Hospital	0		365							
Maternity Homes	1	20	365	591.940		178.708	20.383	833.575	475.211	2099.817
Specialty Hospitals										
Eye	13	69	300	0.000	35.302	319.927	111.924	481.395	490.221	1438.770
Dental			300							
Infectious Disease			365							
Leprosy			365							
Cancer			365							
TB	2	1803	365		3714.001	13178.189	3681.423	67047.500	32888.461	120509.575
A. Bedded Gr. Total	168	6519		48637.746	9356.810	50264.041	13524.758	288495.760	178868.422	589147.538
* Eye and Dental Hospitals are closed on Sundays and some holidays.										

BMW Generation in Nadia District (Weight in Kg)										
B. Non-Bedded Facilities										
Health Care Unit (HCU) Categories	No. of Units	Average No. of Patients	Frequency - Days in a Year*	CAT 1	CAT 3	CAT 4	CAT 5	CAT 6	CAT 7	Total Generation in a Year
Government										
Rural	469	30	50			2763.750		1870.417	17387.431	22021.597
Urban	98	30	50			609.894		390.957	3714.096	4714.947
Municipality										
ESOPD	0	30	300							
Sub Centres	61	50	104			1558.655		1535.412	6894.998	9989.066
B. Non-Bedded Gr. Total						4932.299		3796.786	27996.525	36725.610
* Clinical activities held in Govt. Sub Centres average 50 per year and Municipal Immunisation Centres twice in a week. Municipal Clinics are closed on Sundays and some holidays.										

BMW Generation in Nadia District (Weight in Kg)										
C. Pathological Laboratories										
Health Care Unit (HCU) Categories	No. of Units	Average No. of Tests / Month	No. of Months in a Year	CAT 1	CAT 3	CAT 4	CAT 5	CAT 6	CAT 7	Total Generation in a Year
Large		2000	12							
Medium	37	500	12		1456.746	617.459		391.057	4164.418	6629.680
Small	149	250	12		2646.514	1466.743		924.686	8545.371	13583.314
C. Path Lab Gr. Total	186				4103.260	2084.202		1315.743	12709.789	20212.995

Annual BMW Generation in Nadia District							
(Rounded off to Kg)							
Categories	CAT 1	CAT 3	CAT 4	CAT 5	CAT 6	CAT 7	Total BMW
A. Bedded Facilities	48638	9357	50264	13525	288496	178868	589148
B. Non-Bedded Facilities			4932		3797	27997	36726
C. Pathological Centres		4103	2084		1316	12710	20213
Gr. Total	48638	13460	57281	13525	293608	219575	646086

BMW Generation in North 24 Parganas District (Weight in Kg)										
A. Bedded Facilities										
Health Care Unit (HCU) Categories	No. of Units	Total Bed Strength	Frequency - Days in a Year*	CAT 1	CAT 3	CAT 4	CAT 5	CAT 6	CAT 7	Total Generation in a Year
Government										
MCH			365							
DH	1	500	365	5003.761	813.792	3117.343	756.923	25109.064	13156.427	47957.310
SDH	4	750	365	5650.149	1563.650	4179.443	1323.564	36189.177	18060.114	66966.097
SGH	10	974	365	9708.125	1226.576	6514.597	2001.271	43638.948	24439.785	87529.302
RH	8	265	365	2246.486	419.379	2246.960	534.358	10395.567	6143.460	21986.209
BPHC	15	204	365	1455.355	729.793	1956.690	447.747	8313.290	3205.447	16108.321
PHC	52	302	365	3616.922		2813.161	643.008	9989.594	5769.852	22832.537
Other Government										
< 50 Beds (BPHC)	6	134	365	955.968	479.374	1285.277	294.108	5460.690	2105.538	10580.956
50 - 100 Beds (RH)	1	100	365	847.730	158.256	847.909	201.645	3922.855	2318.287	8296.683
> 101 - 300 Beds (SGH)	3	465	365	4634.782	585.583	3110.151	955.432	20833.789	11667.865	41787.603
> 300 Beds (DH)	1	325	365	3252.445	528.965	2026.273	492.000	16320.892	8551.678	31172.252
Private										
Small (< 50 Beds)	240	2634	365	30711.708		23501.133	5608.225	130858.583	108959.800	299639.450
Medium (50 - 100 Beds)	18	1125	365	9588.771	4049.845	9509.804	2741.260	66670.158	59585.749	152145.587
Large (101 - 300 Beds)	4	681	365	8888.082	1765.376	9660.140	2805.772	50946.410	55847.095	129912.874
Very Large (> 300 Beds)			365							
Municipality										
Hospital	14	395	365	5198.063	281.141	2879.341	553.410	16791.674	10737.988	36441.618
Maternity Homes	7	185	365	5475.444		1653.047	188.544	7710.566	4395.702	19423.303
Specialty Hospitals										
Eye	30	231	300		118.186	1071.061	374.703	1611.628	1641.174	4816.753
Dental			300							
Infectious Disease			365							
Leprosy	1	173	365	428.484	489.374	1008.065	410.443	7789.387	4674.985	14800.737
Cancer	3	50	365	75.622	69.320	490.532	33.526	2473.581	1230.110	4372.690
TB	1	94	365		193.631	687.049	191.932	3495.544	1714.651	6282.806
A. Bedded Gr. Total	419	9587		97737.896	13472.241	78557.977	20557.872	468521.395	344205.705	1023053.087
* Eye and Dental Hospitals are closed on Sundays and some holidays.										

BMW Generation in North 24 Parganas District (Weight in Kg)										
B. Non-Bedded Facilities										
Health Care Unit (HCU) Categories	No. of Units	Average No. of Patients	Frequency - Days in a Year*	CAT 1	CAT 3	CAT 4	CAT 5	CAT 6	CAT 7	Total Generation in a Year
Government										
Rural	742	30	50			4372.500		2959.167	27508.472	34840.139
Urban	485	30	50			3018.351		1934.840	18380.984	23334.176
Municipality										
ESOPD	18	30	300			805.500		564.750	2515.500	3885.750
Sub Centres	506	50	104			12929.172		12736.369	57194.576	82860.117
B. Non-Bedded Gr. Total						21125.523		18195.126	105599.532	144920.182
* Clinical activities held in Govt. Sub Centres average 50 per year and Municipal Immunisation Centres twice in a week. Municipal Clinics are closed on Sundays and some holidays.										

BMW Generation in North 24 Parganas District (Weight in Kg)										
C. Pathological Laboratories										
Health Care Unit (HCU) Categories	No. of Units	Average No. of Tests / Month	No. of Months in a Year	CAT 1	CAT 3	CAT 4	CAT 5	CAT 6	CAT 7	Total Generation in a Year
Large		2000	12							
Medium	62	500	12		2443.574	1035.738		655.967	6985.475	11120.754
Small	250	250	12		4439.314	2460.343		1551.086	14334.171	22784.914
C. Path Lab Gr. Total	312				6882.888	3496.081		2207.053	21319.647	33905.668

Annual BMW Generation in North 24 Parganas District							
(Rounded off to Kg)							
Categories	CAT 1	CAT 3	CAT 4	CAT 5	CAT 6	CAT 7	Total BMW
A. Bedded Facilities	97738	13472	78558	20558	468521	344206	1023053
B. Non-Bedded Facilities			21126		18195	105600	144920
C. Pathological Centres		6883	3496		2207	21320	33906
Gr. Total	97738	20355	103180	20558	488924	471125	1201879

BMW Generation in Purulia District (Weight in Kg)										
A. Bedded Facilities										
Health Care Unit (HCU) Categories	No. of Units	Total Bed Strength	Frequency - Days in a Year*	CAT 1	CAT 3	CAT 4	CAT 5	CAT 6	CAT 7	Total Generation in a Year
Government										
MCH			365							
DH	1	500	365	5003.761	813.792	3117.343	756.923	25109.064	13156.427	47957.310
SDH	1	68	365	512.280	141.771	378.936	120.003	3281.152	1637.450	6071.593
SGH			365							
RH	6	180	365	1525.915	284.861	1526.237	362.960	7061.140	4172.916	14934.029
BPHC	15	225	365	1605.170	804.918	2158.114	493.839	9169.070	3535.419	17766.531
PHC	54	242	365	2898.328		2254.255	515.258	8004.906	4623.523	18296.271
Other Government										
< 50 Beds (BPHC)	3	63	365	449.448	225.377	604.272	138.275	2567.339	989.917	4974.629
50 - 100 Beds (RH)			365	0.000	0.000	0.000	0.000	0.000	0.000	0.000
> 101 - 300 Beds (SGH)	2	398	365	3966.975	501.209	2662.022	817.768	17831.932	9986.688	35766.594
> 300 Beds (DH)			365	0.000	0.000	0.000	0.000	0.000	0.000	0.000
Private										
Small (< 50 Beds)	7	75	365	874.479		669.167	159.688	3726.042	3102.500	8531.875
Medium (50 - 100 Beds)			365							
Large (101 - 300 Beds)	1	250	365	3262.879	648.082	3546.307	1030.019	18702.794	20501.870	47691.951
Very Large (> 300 Beds)			365							
Municipality										
Hospital	0		365							
Maternity Homes	0		365							
Specialty Hospitals										
Eye	1	5	300		2.558	23.183	8.110	34.884	35.523	104.259
Dental			300							
Infectious Disease			365							
Leprosy	4	397	365	983.284	1123.014	2313.305	941.883	17875.067	10728.145	33964.697
Cancer			365							
TB			365							
A. Bedded Gr. Total	95	2403		21082.519	4545.583	19253.141	5344.726	113363.388	72470.380	236059.737
* Eye and Dental Hospitals are closed on Sundays and some holidays.										

BMW Generation in Purulia District (Weight in Kg)										
B. Non-Bedded Facilities										
Health Care Unit (HCU) Categories	No. of Units	Average No. of Patients	Frequency - Days in a Year*	CAT 1	CAT 3	CAT 4	CAT 5	CAT 6	CAT 7	Total Generation in a Year
Government										
Rural	485	30	50			2858.036	0.000	1934.226	17980.605	22772.867
Urban	26	30	50			161.809	0.000	103.723	985.372	1250.904
Municipality										
ESOPD	0	30	300							
Sub Centres	11	50	104			281.069		276.878	1243.360	1801.307
B. Non-Bedded Gr. Total						3300.913		2314.827	20209.338	25825.078
* Clinical activities held in Govt. Sub Centres average 50 per year and Municipal Immunisation Centres twice in a week. Municipal Clinics are closed on Sundays and some holidays.										

BMW Generation in Purulia District (Weight in Kg)										
C. Pathological Laboratories										
Health Care Unit (HCU) Categories	No. of Units	Average No. of Tests / Month	No. of Months in a Year	CAT 1	CAT 3	CAT 4	CAT 5	CAT 6	CAT 7	Total Generation in a Year
Large		2000	12							
Medium	8	500	12		297.615	126.148		79.893	850.795	1354.451
Small	30	250	12		540.686	299.657		188.914	1745.829	2775.086
C. Path Lab Gr. Total	38				838.300	425.805		268.808	2596.624	4129.537

Annual BMW Generation in Purulia District							
(Rounded off to Kg)							
Categories	CAT 1	CAT 3	CAT 4	CAT 5	CAT 6	CAT 7	Total BMW
A. Bedded Facilities	21083	4546	19253	5345	113363	72470	236060
B. Non-Bedded Facilities			3301		2315	20209	25825
C. Pathological Centres		838	426		269	2597	4130
Gr. Total	21083	5384	22980	5345	115947	95276	266014

BMW Generation in South 24 Parganas District (Weight in Kg)										
A. Bedded Facilities										
Health Care Unit (HCU) Categories	No. of Units	Total Bed Strength	Frequency - Days in a Year*	CAT 1	CAT 3	CAT 4	CAT 5	CAT 6	CAT 7	Total Generation in a Year
Government										
MCH			365							
DH			365							
SDH	4	361	365	2719.605	752.637	2011.705	637.075	17419.057	8692.935	32233.015
SGH	1	15	365	149.509	18.890	100.327	30.820	672.058	376.383	1347.987
RH	9	345	365	2924.670	545.984	2925.287	695.674	13533.851	7998.089	28623.555
BPHC	18	227	365	1619.439	812.073	2177.298	498.228	9250.572	3566.845	17924.455
PHC	65	373	365	4467.258		3474.534	794.179	12338.141	7126.340	28200.451
Other Government										
< 50 Beds (BPHC)			365							
50 - 100 Beds (RH)			365							
> 101 - 300 Beds (SGH)	2	510	365	5083.310	642.252	3411.134	1047.894	22849.962	12797.013	45831.565
> 300 Beds (DH)			365							
Private										
Small (< 50 Beds)	166	1220	365	14224.861		10885.111	2597.583	60610.278	50467.333	138785.167
Medium (50 - 100 Beds)	5	335	365	2855.323	1205.954	2831.808	816.286	19852.891	17743.312	45305.575
Large (101 - 300 Beds)	2	270	365	3523.909	699.929	3830.011	1112.420	20199.017	22142.020	51507.307
Very Large (> 300 Beds)			365							
Municipality										
Hospital	4	68	365	894.856	48.399	495.684	95.271	2890.719	1848.565	6273.494
Maternity Homes	4	44	365	1302.268		393.157	44.843	1833.864	1045.464	4619.596
Specialty Hospitals										
Eye	8	65	300	0.000	33.256	301.381	105.436	453.488	461.802	1355.363
Dental			300							
Infectious Disease			365							
Leprosy			365							
Cancer			365							
TB			365							
A. Bedded Gr. Total	288	3833		39765.007	4759.374	32837.438	8475.711	181903.899	134266.101	402007.530
* Eye and Dental Hospitals are closed on Sundays and some holidays.										

BMW Generation in South 24 Parganas District (Weight in Kg)										
B. Non-Bedded Facilities										
Health Care Unit (HCU) Categories	No. of Units	Average No. of Patients	Frequency - Days in a Year*	CAT 1	CAT 3	CAT 4	CAT 5	CAT 6	CAT 7	Total Generation in a Year
Government										
Rural	1068	30	50			6293.571		4259.286	39594.405	50147.262
Urban	109	30	50			678.351		434.840	4130.984	5244.176
Municipality										
ESOPD	3	30	300			134.250		94.125	419.250	647.625
Sub Centres	112	50	104			2861.793		2819.117	12659.669	18340.579
B. Non-Bedded Gr. Total						9967.966		7607.368	56804.308	74379.642
* Clinical activities held in Govt. Sub Centres average 50 per year and Municipal Immunisation Centres twice in a week. Municipal Clinics are closed on Sundays and some holidays.										

BMW Generation in South 24 Parganas District (Weight in Kg)										
C. Pathological Laboratories										
Health Care Unit (HCU) Categories	No. of Units	Average No. of Tests / Month	No. of Months in a Year	CAT 1	CAT 3	CAT 4	CAT 5	CAT 6	CAT 7	Total Generation in a Year
Large		2000	12							
Medium	19	500	12		728.373	308.730		195.529	2082.209	3314.840
Small	74	250	12		1323.257	733.371		462.343	4272.686	6791.657
C. Path Lab Gr. Total	93				2051.630	1042.101		657.872	6354.895	10106.497

Annual BMW Generation in South 24 Parganas District							
(Rounded off to Kg)							
Categories	CAT 1	CAT 3	CAT 4	CAT 5	CAT 6	CAT 7	Total BMW
A. Bedded Facilities	39765	4759	32837	8476	181904	134266	402008
B. Non-Bedded Facilities			9968		7607	56804	74380
C. Pathological Centres		2052	1042		658	6355	10106
Gr. Total	39765	6811	43848	8476	190169	197425	486494

BMW Generation in Uttar Dinajpur District (Weight in Kg)										
A. Bedded Facilities										
Health Care Unit (HCU) Categories	No. of Units	Total Bed Strength	Frequency - Days in a Year*	CAT 1	CAT 3	CAT 4	CAT 5	CAT 6	CAT 7	Total Generation in a Year
Government										
MCH			365							
DH	1	168	365	1681.264	273.434	1047.427	254.326	8436.645	4420.559	16113.656
SDH	1	68	365	512.280	141.771	378.936	120.003	3281.152	1637.450	6071.593
SGH			365							
RH	1	30	365	254.319	47.477	254.373	60.493	1176.857	695.486	2489.005
BPHC	7	161	365	1148.589	575.964	1544.251	353.369	6560.979	2529.789	12712.940
PHC	23	128	365	1533.000	0.000	1192.333	272.533	4234.000	2445.500	9677.367
Other Government										
< 50 Beds (BPHC)	1	50	365	356.705	178.871	479.581	109.742	2037.571	785.649	3948.118
50 - 100 Beds (RH)			365							
> 101 - 300 Beds (SGH)			365							
> 300 Beds (DH)			365							
Private										
Small (< 50 Beds)	15	169	365	1970.493		1507.856	359.829	8396.014	6990.967	19225.158
Medium (50 - 100 Beds)	1	50	365	426.168	179.993	422.658	121.834	2963.118	2648.255	6762.026
Large (101 - 300 Beds)			365							
Very Large (> 300 Beds)			365							
Municipality										
Hospital	0		365							
Maternity Homes	1	10	365	295.970	0.000	89.354	10.192	416.787	237.606	1049.908
Specialty Hospitals										
Eye	2	10	300	0.000	5.116	46.366	16.221	69.767	71.047	208.517
Dental			300							
Infectious Disease			365							
Leprosy			365							
Cancer			365							
TB			365							
A. Bedded Gr. Total	53	844		8178.787	1402.626	6963.135	1678.543	37572.891	22462.307	78258.288

* Eye and Dental Hospitals are closed on Sundays and some holidays.

BMW Generation in Uttar Dinajpur District (Weight in Kg)										
B. Non-Bedded Facilities										
Health Care Unit (HCU) Categories	No. of Units	Average No. of Patients	Frequency - Days in a Year*	CAT 1	CAT 3	CAT 4	CAT 5	CAT 6	CAT 7	Total Generation in a Year
Government										
Rural	344	30	50			2027.143		1371.905	12753.254	16152.302
Urban	29	30	50			180.479		115.691	1099.069	1395.239
Municipality										
ESOPD	1	30	300			44.750		31.375	139.750	215.875
Sub Centres	25	50	104			638.793		629.267	2825.819	4093.879
B. Non-Bedded Gr. Total						2891.165		2148.238	16817.892	21857.295
* Clinical activities held in Govt. Sub Centres average 50 per year and Municipal Immunisation Centres twice in a week. Municipal Clinics are closed on Sundays and some holidays.										

BMW Generation in Uttar Dinajpur District (Weight in Kg)										
C. Pathological Laboratories										
Health Care Unit (HCU) Categories	No. of Units	Average No. of Tests / Month	No. of Months in a Year	CAT 1	CAT 3	CAT 4	CAT 5	CAT 6	CAT 7	Total Generation in a Year
Large		2000	12							
Medium	10	500	12		375.934	159.344		100.918	1074.689	1710.885
Small	38	250	12		682.971	378.514		238.629	2205.257	3505.371
C. Path Lab Gr. Total	48				1058.906	537.859		339.547	3279.946	5216.257

Annual BMW Generation in Uttar Dinajpur District							
(Rounded off to Kg)							
Categories	CAT 1	CAT 3	CAT 4	CAT 5	CAT 6	CAT 7	Total BMW
A. Bedded Facilities	8179	1403	6963	1679	37573	22462	78258
B. Non-Bedded Facilities			2891		2148	16818	21857
C. Pathological Centres		1059	538		340	3280	5216
Gr. Total	8179	2462	10392	1679	40061	42560	105332

BMW Generation in West Midnapore District (Weight in Kg)										
A. Bedded Facilities										
Health Care Unit (HCU) Categories	No. of Units	Total Bed Strength	Frequency - Days in a Year*	CAT 1	CAT 3	CAT 4	CAT 5	CAT 6	CAT 7	Total Generation in a Year
Government										
MCH	2	611	365	6308.989	666.436	3435.312	708.989	33057.239	18550.765	62727.729
DH			365							
SDH	3	672	365	5062.533	1401.031	3744.781	1185.913	32425.502	16181.862	60001.623
SGH			365							
RH	9	345	365	2924.670	545.984	2925.287	695.674	13533.851	7998.089	28623.555
BPHC	20	265	365	1890.534	948.015	2541.779	581.632	10799.126	4163.938	20925.025
PHC	84	446	365	5341.547	0.000	4154.536	949.608	14752.844	8521.039	33719.574
Other Government										
< 50 Beds (BPHC)	4	94	365	670.605	336.277	901.612	206.315	3830.634	1477.020	7422.462
50 - 100 Beds (RH)	2	149	365	1263.118	235.802	1263.385	300.450	5845.055	3454.247	12362.057
> 101 - 300 Beds (SGH)	1	130	365	1295.746	163.711	869.505	267.110	5824.500	3261.984	11682.556
> 300 Beds (DH)	1	340	365	3402.557	553.379	2119.793	514.708	17074.163	8946.370	32610.971
Private										
Small (< 50 Beds)	142	1280	365	14924.444		11420.444	2725.333	63591.111	52949.333	145610.667
Medium (50 - 100 Beds)	2	150	365	1278.503	539.979	1267.974	365.501	8889.354	7944.766	20286.078
Large (101 - 300 Beds)			365							
Very Large (> 300 Beds)			365							
Municipality										
Hospital	1	10	365	131.597	7.118	72.895	14.010	425.106	271.848	922.573
Maternity Homes	1	10	365	295.970	0.000	89.354	10.192	416.787	237.606	1049.908
Specialty Hospitals										
Eye	6	53	300		27.116	245.741	85.971	369.767	376.547	1105.142
Dental			300							
Infectious Disease			365							
Leprosy	1	10	365	24.768	28.288	58.270	23.725	450.254	270.230	855.534
Cancer			365							
TB	1	317	365		652.989	2316.964	647.261	11788.163	5782.386	21187.762
A. Bedded Gr. Total	280	4882		44815.580	6106.124	37427.632	9282.393	223073.456	140388.030	461093.215
* Eye and Dental Hospitals are closed on Sundays and some holidays.										

BMW Generation in West Midnapore District (Weight in Kg)										
B. Non-Bedded Facilities										
Health Care Unit (HCU) Categories	No. of Units	Average No. of Patients	Frequency - Days in a Year*	CAT 1	CAT 3	CAT 4	CAT 5	CAT 6	CAT 7	Total Generation in a Year
Government										
Rural	858	30	50			5056.071		3421.786	31808.988	40286.845
Urban	64	30	50			398.298		255.319	2425.532	3079.149
Municipality										
ESOPD	1	30	300			44.750		31.375	139.750	215.875
Sub Centres	56	50	104			1430.897		1409.559	6329.834	9170.290
B. Non-Bedded Gr. Total						6930.016		5118.038	40704.104	52752.159
* Clinical activities held in Govt. Sub Centres average 50 per year and Municipal Immunisation Centres twice in a week. Municipal Clinics are closed on Sundays and some holidays.										

BMW Generation in West Midnapore District (Weight in Kg)										
C. Pathological Laboratories										
Health Care Unit (HCU) Categories	No. of Units	Average No. of Tests / Month	No. of Months in a Year	CAT 1	CAT 3	CAT 4	CAT 5	CAT 6	CAT 7	Total Generation in a Year
Large		2000	12							
Medium	30	500	12		1182.627	501.270		317.471	3380.791	5382.160
Small	121	250	12		2148.514	1190.743		750.686	6937.371	11027.314
C. Path Lab Gr. Total	151				3331.141	1692.013		1068.157	10318.162	16409.474

(Rounded off to Kg)							
Categories	CAT 1	CAT 3	CAT 4	CAT 5	CAT 6	CAT 7	Total BMW
A. Bedded Facilities	44816	6106	37428	9282	223073	140388	461093
B. Non-Bedded Facilities			6930		5118	40704	52752
C. Pathological Centres		3331	1692		1068	10318	16409
Gr. Total	44816	9437	46050	9282	229260	191410	530255